



2026 ÜRÜN KATALOĐU

PRODUCT CATALOG

TEKNOLOJİK YENİLİK VE GÜVENİLİR ÜRETİMDE PROFESYONEL ÇÖZÜM ORTAĐINIZ.
INNOVATIVE, RELIABLE, AND COMMITTED TO EXCELLENCE.

netahavuz.com

BİZİMLE İLETİŞİMDE KALIN!

0216 345 75 45
satis@netahavuz.com

Whatsapp iletişim:
+90 554 625 70 97

netahavuz.com

CONTACT FOR SALES!

+90 216 345 75 45
export@netahavuz.com

Whatsapp contact:
+90 507 819 08 29

SOSYAL MEDYA SOCIAL MEDIA

 /neta-havuz

 /neta.pool

 /NetaHavuzTürkiye

 /netahavuz

 /NetaHavuzTurkey

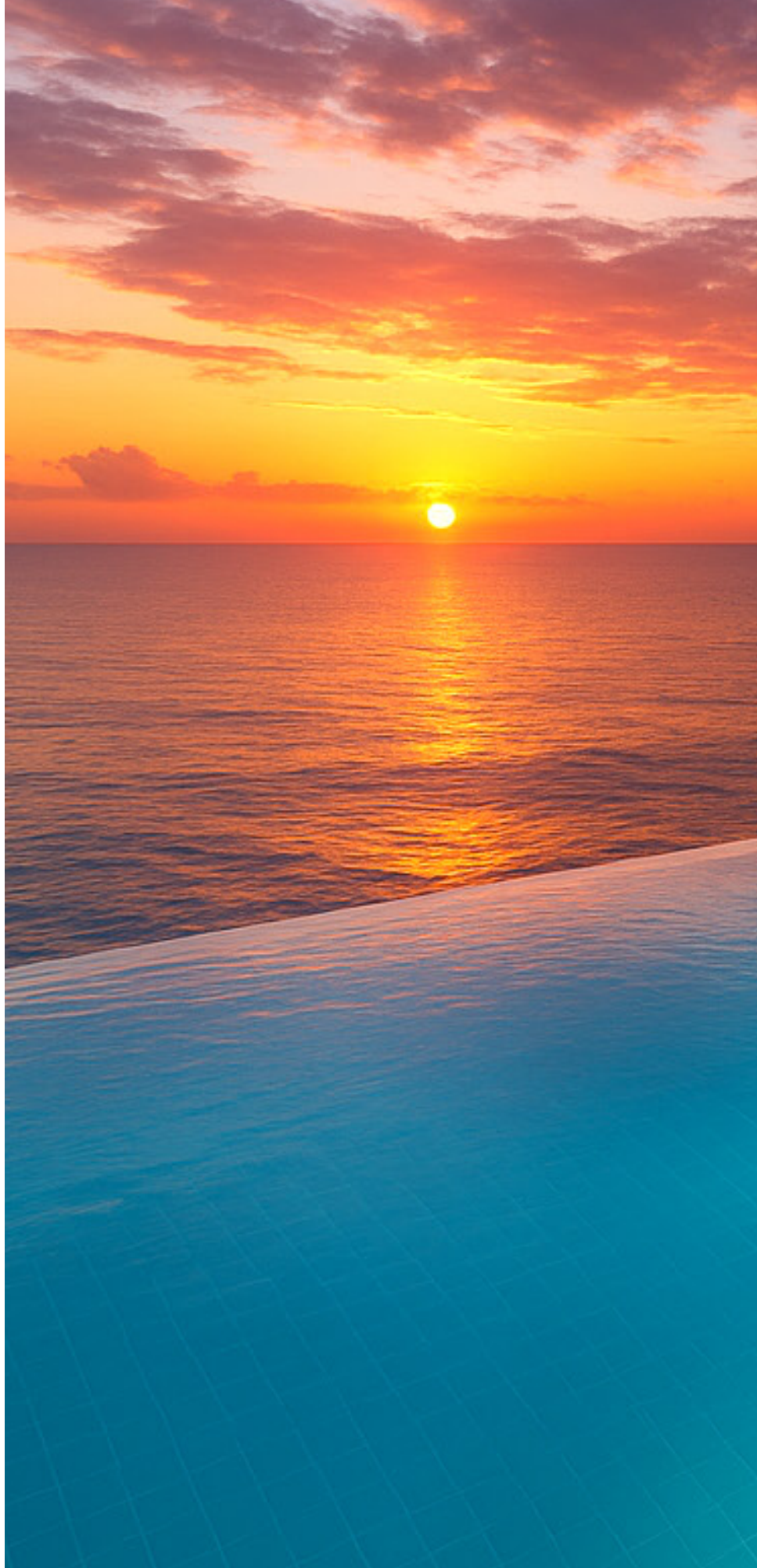

İçindekiler / Table of Contents

NO 01	Pompalar Pumps	SAYFA / PAGES 06-33
NO 02	Filtreler Filters	SAYFA / PAGES 34-59
NO 03	Havuz İçi ve Elektrik Ekipmanları White Equipment and Lights	SAYFA / PAGES 60-85
NO 04	Havuz Kenar Ekipmanları Pool Outdoor Equipment	SAYFA / PAGES 86-101
NO 05	Temizlik Ekipmanları Pool Cleaning Equipment	SAYFA / PAGES 102-125
NO 06	Dezenfeksiyon Ekipmanları Disinfection Equipment	SAYFA / PAGES 126-157
NO 07	Havuz Kimyasalları Pool Chemicals	SAYFA / PAGES 158-171
NO 08	Isıtma ve Nem Alma Ekipmanları Heating and Dehumidifiers Product	SAYFA / PAGES 172-195
NO 09	Havuz İçi ve Kenar Kaplama Ekipmanları Pool Indoor and Outdoor Equipment	SAYFA / PAGES 196-215

NO
10

Jakuzi ve Spa Ekipmanları
Jacuzzi and Spa Equipment

SAYFA / PAGES
216-221

NO
11

Sauna ve Buhar Ekipmanları
Sauna and Steam Equipment

SAYFA / PAGES
222-235

NO
12

Süs Havuzu Ekipmanları
Fountain Equipment

SAYFA / PAGES
236-245

NO
13

Bahçe ve Gölet Ekipmanları
Garden and Pond Equipment

SAYFA / PAGES
246-259

NO
14

Olimpik Havuz Ekipmanları
Olympic Pool Equipment

SAYFA / PAGES
260-265

NO
15

Fiberglass ve Yer Üstü Havuzlar ve Spalar
Fiberglass and Above Ground Pools and Spas

SAYFA / PAGES
266-277

NO
16

Su Yalıtım Membranı
Waterproofing Membrane

SAYFA / PAGES
278-279

NO
17

Pvc Vana Boru ve Ek Parçalar
Pvc Valve Pipes and Fittings

SAYFA / PAGES
280-295

NO
18

Yedek Parçalar
Spare Parts

SAYFA / PAGES
300-323

POMPALAR PUMPS



HAVUZ SİRKÜLASYON POMPALARI POOL CIRCULATION PUMPS

Konut ve ticari havuzlar için yüksek performans ve güvenilirlik.
High performance and reliability for residential and commercial pools.

Doğru pompa seçimi, sistemin kalbini korur.

Proper pump selection ensures the heart of the system stays strong.

**Doğru pompa seçimi, hem filtrasyon kalitesini hem enerji verimliliğini belirler.
Neta Havuz, her havuz tipine uygun güvenilir pompa çözümleri sunar.**

*Proper pump selection ensures both filtration quality and energy efficiency.
Neta Pool offers reliable pump solutions for every pool type.*

senkron

Senkron® Pompalar

Senkron® Pumps

GÜVENİLİR PERFORMANS TRUSTED PERFORMANCE

Senkron® pompalar, 100.000'e yaklaşan satış adediyle yıllardır havuz profesyonellerinin güvenini kazanıyor. Sessiz çalışma, uzun ömür ve farklı ihtiyaçlara uygun geniş model yelpazesıyla Senkron, yerli üretimde kaliteyi temsil eder.

With nearly 100,000 units sold, Senkron® pumps have earned the trust of pool professionals for years. Offering quiet operation, long life, and a wide model range, Senkron is a symbol of quality in domestic production.

water fun → senkron



Güç
Power
0.5-12.50 HP



Debi
Flow
8-33 m³/h



Motor
IP55
Sessiz Silent



Bağlantı
Connection
Ø50-63 mm



Ses
Sound
Titreşimsiz
No Vibration



Üretim
Production
Yerli
Locally Made



Model: Senkron 1

CE

Senkron Pompalar Karşılaştırması

Senkron Pumps Comparison

Havuz Sirkülasyonu
Pool Circulation

Küçük Göletler
Small Water Pond

Süs Havuzları
Fountains

Model:	Senkron 1	Senkron 2	Senkron 3	Senkron Jet
GÜÇ POWER	0.50 - 1.50 Hp	1.50 - 4.00 Hp	4.50 - 12.50 Hp	3.00 - 4.00 Hp
BAĞLANTI CONNECTION	50 mm	63 mm	110 mm	90 mm
GÜÇ kW POWER kW	0,38 - 1,1	1,10 - 3,00	3,4 - 10,00	2,2 - 3

NEDEN SENKRON® POMPA SEÇMELİSİNİZ?

WHY CHOOSE A SENKRON® PUMP?

senkron



Motor Koruma Overheat Protection

Aşırı ısınmaya karşı koruma rölesi sayesinde motor, güvenle çalışır.

The integrated overheat protection relay ensures reliable motor operation.



Dayanıklı ve Bakım Gerektirmeyen Tasarım Durable & Maintenance-Free

Yıllarca sorunsuz kullanım.

Designed for long-lasting performance with minimal need for spare parts.



Fişli Kablo Plug-In Connection

Kullanıma hazır kablo yapısı kolay montaj sağlar.

Easy-to-install design with pre-wired power cable.



Tuzlu Suya Uyumlu Saltwater Compatible

Tuzlu su içeren havuzlar için uygundur.
Ideal for use in saltwater pools.



Kolay Bakım Easy Service Access

Ergonomik kapak anahtarı ve çift boşaltma tapası sayesinde hızlı bakım imkanı.

Dual drain plugs and ergonomic lid tool for quick serviceability.



Düşmeyen Gözetleme Camı Secure Inspection Lid

Ön kapağın düşmemesi için özel tasarlanmış gözetleme camı.

The lid stays securely in place during maintenance.



AISI 316 Paslanmaz Mil AISI 316 Stainless Steel Shaft

Korozyona dayanıklı malzeme.

Corrosion-resistant shaft for extended durability.



1½" Bağlantı Rakoru 1½" Union Connection

Standart bağlantılarla uyumlu, hızlı kurulum sağlar.

Compatible with standard fittings for easy installation.

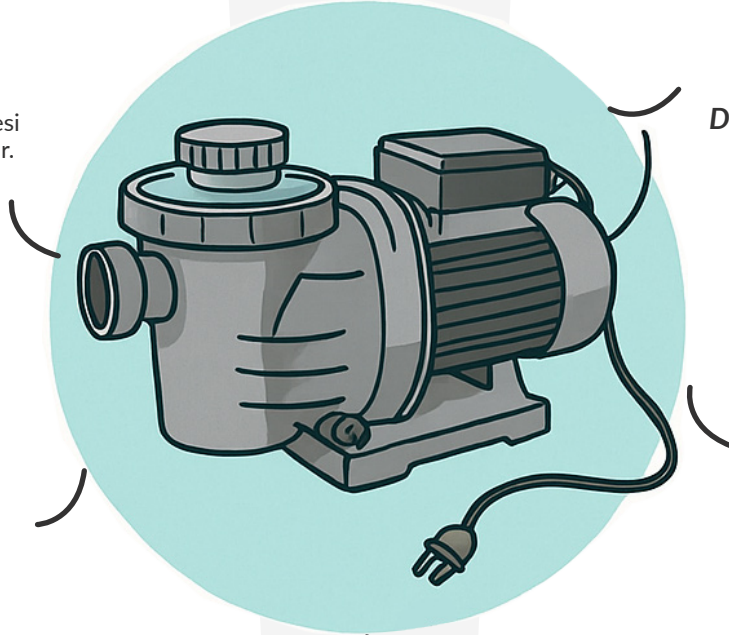

SENKRON® POMPAYI SEÇMEK İÇİN 3 NEDEN

3 REASONS TO CHOOSE SENKRON® PUMP

1. Fişli Yapı:

Kolay Kurulum

2. Sessiz ve Uzun Ömürlü Performans

3. Tuzlu Suya Dayanıklılık

1. Plug-in Design:

Easy Setup

2. Quiet and Durable Performance

3. Saltwater-resistance

ÜRÜN VİDEOSUNU
İZLEYİN

WATCH THE
PRODUCT VIDEO



MÜŞTERİ GERİ BİLDİRİMLERİ CUSTOMER FEEDBACK

Çok iyi değil, muhteşem. Daha iyisini kullanmadık.
Not so good, fabulous. We have not used better.

Senkron 1



TEMEL GÜÇ CORE POWER

Sessiz ve sağlam, giriş seviyesi havuz sistemleri için uygundur.

Silent and solid, built for entry-level pool systems. No need for spare parts.



Öne Çıkan Özellikler Product Features

- » Aşırı ısınmaya karşı koruma rölesi
- » 1 ½ bağlantı rakorları
- » Düşmeyen gözetleme camı
- » Ergonomik ön filtre kapak anahtarı
- » Fişli elektrik bağlantı kablosu
- » AISI 316 paslanmaz çelik mil
- » Çift boşaltma tapası
- » Tuzlu suda kullanılabilir
- » Over heat protection relay
- » 1 ½ 1/2" connection fittings
- » Non-falling sight glass
- » Ergonomic prefilter lid key
- » Type F power plug
- » AISI 316 stainless steel shaft
- » Double drain plug
- » Can be used in salt water

Teknik Bilgiler Technical Information

MODEL	BASMA YÜKSEKLİĞİ HEAD IN METERS					
	4	6	8	10	12	16
SEN1 0,50	20	17	15	11,7	7	-
SEN1 0,75	22	20	17,8	15,3	12,8	-
SEN1 1,00	24	22,5	20,8	20,04	16,5	7,2
SEN1 1,50	29,5	28	25,5	24	21	13,8

*8 mss basma yüksekliğinde 8 mss water column pressure

Daha fazlasını keşfedin

Senkron 1'in avantajlarını görmek için QR kodu okutun.

Discover more

Scan to explore the benefits of Senkron 1.

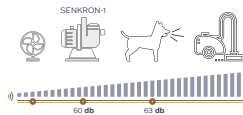

Ölçüler Dimensions

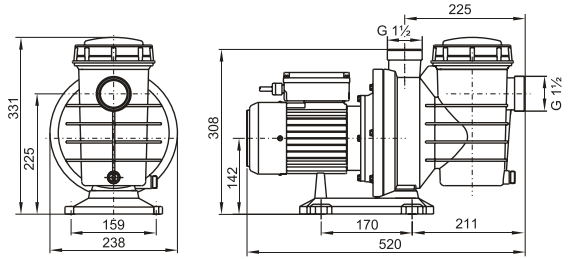

Performans Eğrisi Performance Curves

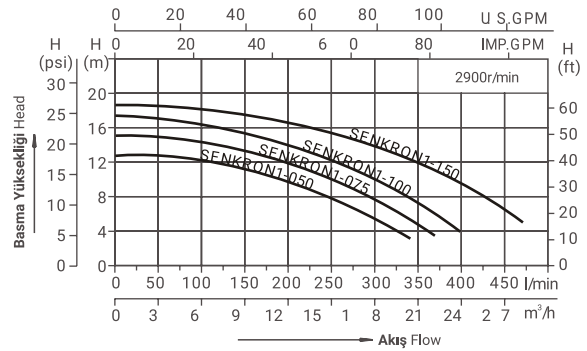

KOD CODE	MODEL MODEL	GÜÇ HP POWER HP	BAĞLANTI GİRİŞ ÇIKIŞ INLET OUTLET	DEBİ m³/h FLOW	GÜÇ KW POWER	AĞIRLIK Kg WEIGHT Kg	PAKET PACKAGE	FİYAT PRICE
11515123068	SEN1.050 M	0,50	50 mm	*15	0,38	10,6	25x55x38	253 €
11515123069	SEN1.075 M	0,75	50 mm	*17,8	0,56	11,5	25x55x38	280 €
11515123070	SEN1.100 M	1,00	50 mm	*20,8	0,75	12	25x55x38	284 €
11515123071	SEN1.100 T	1,00	50 mm	*20,8	0,75	11,6	25x55x38	286 €
11515123072	SEN1.150 M	1,50	50 mm	*25,5	1,1	12,7	25x55x38	292 €

Senkron 2



GELİŞMİŞ GÜÇ ADVANCED POWER

Sessizliği, yüksek verimi ve kolay taşınabilirliğiyle profesyonel kullanıma hazır.

Silent, efficient, and built for professional-grade performance.

 ÖZEL AMAÇLI HAVUZ
RESIDENTAL POOL

 UYGUN FİYAT
COMPETITIVE PRICE

 UZUN ÖMÜRLÜ
LONG LASTING

 TÜRK MÜHENDİSLİĞİ
TURKISH ENGINEERING

 TİP F FİŞ BAĞLANTISI
TYPE F PLUG

 SÜPER SESSİZ
SUPER SILENT

 YÜKSEK VERİMLİ
HIGH EFFICIENCY



Öne Çıkan Özellikler Product Features

- » Aşırı ısınmaya karşı koruma rölesi
- » 2" bağlantı rakorları
- » Düşmeyen gözetleme camı
- » Ergonomik ön filtre kapak anahtarı
- » Ergonomik tutma kolu sayesinde kolay taşınabilir
- » AISI 316 paslanmaz çelik mil
- » Çift boşaltma tapası
- » Tuzlu suda kullanılabilir
- » Over heat protection relay
- » 2" connection fittings
- » Non-falling sight glass
- » Ergonomic prefilter lid key
- » Easy to carry thanks to ergonomic handle
- » AISI 316 stainless steel shaft
- » Double drain plug
- » Can be used in salt water

Ölçüler Dimensions

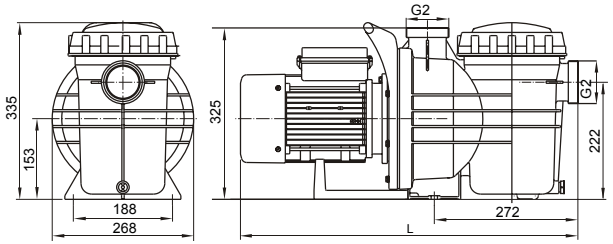

Teknik Bilgiler Technical Information

MODEL	BASMA YÜKSEKLİĞİ HEAD IN METERS					-
	6	8	10	12	16	
	DEBİ m³/h FLOW m³/h					
SEN2 150	22,8	19,8	19,6	13,5	5,8	-
SEN2 200	30	27,3	25,5	14	9	-
SEN2 300	37,5	35	33	30	23,5	
SEN2 400	41	39	39	35	29	

*10 mss basma yüksekliğinde 10 mss water column pressure

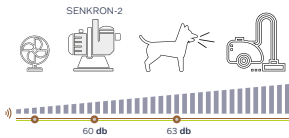

Performans Eğrisi Performance Curves

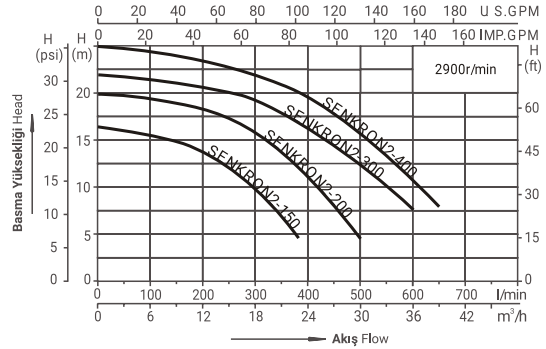

Daha fazlasını keşfedin

Senkron 2'in avantajlarını görmek için QR kodu okutun.

Discover more

Scan to explore the benefits of Senkron 2.



KOD CODE	MODEL MODEL	GÜÇ HP POWER HP	BAĞLANTI GİRİŞ ÇIKIŞ INLET OUTLET	DEBİ m³/h FLOW	GÜÇ KW POWER	AĞIRLIK Kg WEIGHT Kg	PAKET PACKAGE	FİYAT PRICE
11515123073	SEN2.150 M	1,50	63 mm	*19,6	1,10	15,5	30x66x38	353 €
11515123074	SEN2.150 T	1,50	63 mm	*19,6	1,10	15,2	30x66x38	345 €
11515123075	SEN2.200 M	2,00	63 mm	*25,5	1,50	18	30x66x38	395 €
11515123076	SEN2.200 T	2,00	63 mm	*25,5	1,50	17,2	30x66x38	385 €
11515123077	SEN2.300 M	3,00	63 mm	*33,0	2,20	20,5	30x66x38	490 €
11515123078	SEN2.300 T	3,00	63 mm	*33,0	2,20	19	30x66x38	450 €
11515123079	SEN2.400 T	4,00	63 mm	*39,0	3,00	22	30x66x38	510 €

Senkron 3



ÜSTÜN PERFORMANS PEAK PERFORMANCE

Yüksek basınç ve debi gerektiren sistemler için güçlü ve dayanıklı çözüm.

Reliable power for systems demanding high pressure and flow.



Öne Çıkan Özellikler Product Features

- » 4" / 100 mm bağlantı rakorları
- » Düşmeyen çerçevesi ile akuple gözetleme camı
- » Ergonomik ön filtre kapak anahtarı
- » Ergonomik tutma kolu sayesinde kolay taşınabilme
- » AISI 316 paslanmaz çelik mil
- » Çift boşaltma tapası
- » Tuzlu suda kullanılabilir
- » 4" / 100 mm connection fittings
- » Non-falling sight glass
- » Ergonomic prefilter lid key
- » Easy to carry thanks to ergonomic handle
- » AISI 316 stainless steel shaft
- » Double drain plug
- » Can be used in salt water

Ölçüler Dimensions

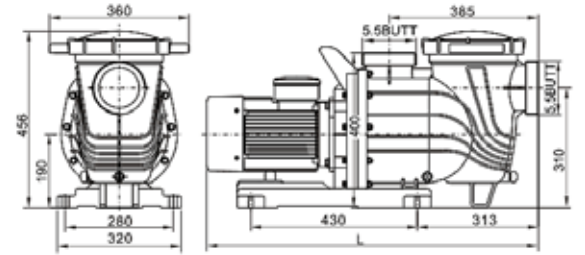

Teknik Bilgiler Technical Information

MODEL	BASMA YÜKSEKLİĞİ HEAD IN METERS				
	6	8	10	12	16
SEN3 450 T	72	63	52	42	0
SEN3 550 T	90	86	76	65	35
SEN3 750 T	98	95	91	85	66
SEN3 1000 T	-	122	114	104	82
SEN3 1250 T	136	124	116	103	-

*10 mss basma yüksekliğinde 10 mss water column pressure

Performans Eğrisi Performance Curves

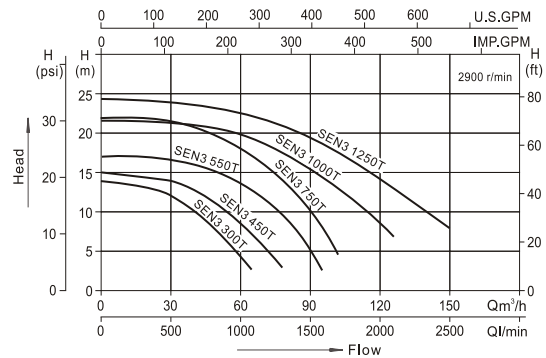

KOD CODE	MODEL MODEL	GÜÇ HP POWER HP	BAĞLANTI GİRİŞ ÇIKIŞ INLET OUTLET	AMPER AMPS	DEBİ m³/h FLOW	GÜÇ KW POWER	AĞIRLIK Kg WEIGHT Kg	PAKET PACKAGE	FİYAT PRICE
11515123082	SEN3 450 T	4,50	110 mm	230/400/50 Hz	*52	3,4	47	840x395x600	975 €
11515123083	SEN3 550 T	5,50	110 mm	400/690/50 Hz	*76	4,10	54,5	930x395x600	1.275 €
11515123085	SEN3 750 T	7,50	110 mm	400/690/50 Hz	*100	5,50	60,3	930x395x600	1.450 €
11515123086	SEN3 1000 T	10,00	110 mm	400/690/50 Hz	*124	7,50	64,5	930x395x600	1.750 €
11515123087	SEN3 1250 T	12,50	110 mm	400/690/50 Hz	*147	10,00	65	930x395x600	1.850 €

Senkron Jet



GÜÇLÜ İTİŞ POWER BOOST

Jet masajı ve su oyunları için yüksek debili güçlü pompa.
High-flow power pump for jet massage and water features.



Öne Çıkan Özellikler Product Features

- » Aşırı ısınmaya karşı koruma rölesi
- » 3" bağlantı rakorları
- » Düşmeyen gözetleme camı
- » Ergonomik ön filtre kapak anahtarı
- » AISI 316 paslanmaz çelik mil
- » Çift boşaltma tapası
- » Tuzlu suda kullanılabilir
- » Over heat protection relay
- » 3" connection fittings
- » Non-falling sight glass
- » Ergonomic prefilter lid key
- » AISI 316 stainless steel shaft
- » Double drain plug
- » Can be used in salt water

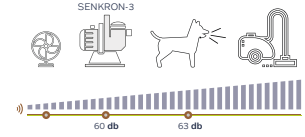

Teknik Bilgiler Technical Information

	BASMA YÜKSEKLİĞİ HEAD IN METERS				
	8	10	12	14	16
	DEBİ m³/h FLOW m³/h				
SENJET 300T	72	62	46	25	0
SENJET 400T	80	76	66	52	30

*10 mss basma yüksekliğinde 10 mss water column pressure

Performans Eğrisi Performance Curves

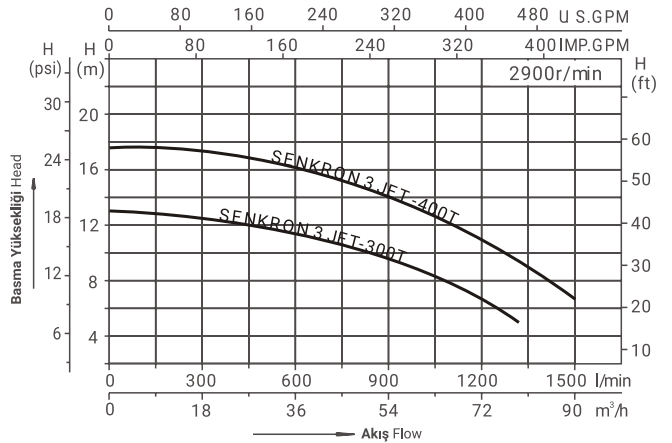

KOD CODE	MODEL MODEL	GÜÇ HP POWER HP	BAĞLANTI GİRİŞ ÇIKIŞ INLET OUTLET	DEBİ m³/h FLOW	GÜÇ KW POWER	AĞIRLIK Kg WEIGHT Kg	PAKET PACKAGE	FİYAT PRICE
11515123080	SENJET 300T	3,00	90 mm	*46	2.2	22	635x300x44	570 €
11515123081	SENJET 400T	4,00	90 mm	*66	3	25,3	675x300x44	585 €

Trione Storm

NETA HAVUZ
PRODUCT

İYİ PERFORMANS COMPACT POWER

Küçük ve yer üstü havuzlar için tasarlanan Trione Storm, dar alanlara kolayca uygulanır ve yüksek verim sunar.

Designed for small and above-ground pools, Trione Storm fits narrow spaces with ease and delivers high efficiency.

ÖZEL AMAÇLI HAVUZ
RESIDENTIAL POOL

TIP F FİŞ BAĞLANTISI
TYPE F PLUG

UZUN ÖMÜRLÜ
LONG LASTING

YÜKSEK VERİMLİ
HIGH EFFICIENCY



CE



Öne Çıkan Özellikler Product Features

- » Küçük havuzlar ve / veya yer üstü havuzları için dizayn edilmiştir
- » Tuzlu suda kullanılabilir
- » Kompakt tasarımı sayesinde dar alanlarda uygulama avantajı sağlar
- » Etkileyici fiyat performans ilişkisi
- » Su geçirmezlik seviyesi IPX5
- » Dijital zamanlayıcı ve açma-kapama paneli
- » Type F fiş bağlantısı

- » Pump designed for small pools and /or above ground pool
- » Can be used in salt water
- » Thanks to its compact design, it offers an advantage in applications within narrow spaces
- » Impressive price-performance ratio
- » Waterproof level IPX5
- » Dijital timer and on-off panel
- » Type F power plug

Teknik Bilgiler Technical Information

Model	Q Max.	H Max.
STORM 0,75	11 m ³ /h	11 meters
STORM 1,00	13 m ³ /h	12 meters

Tak ve Çalıştır Kolaylığı

Type F fiş bağlantısıyla montaj gerektirmeden hemen kullanıma hazır.

Plug & Play Convenience

With its Type F plug connection, it's ready to use instantly – no installation required.



Ölçüler Dimensions

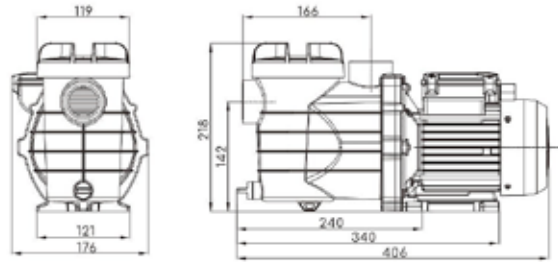

Kullanım kılavuzuna ulaşmak için QR kodu okutun.



Scan the QR code to access the user manual.

KOD CODE	MODEL MODEL	GÜÇ HP POWER HP	BAĞLANTI GİRİŞ ÇIKIŞ INLET OUTLET	DEBİ m ³ /h FLOW max	AĞIRLIK Kg WEIGHT Kg	PAKET UxGxY PACKAGE LxWxH	FİYAT PRICE
11515124001	Storm 0,75	0,75	50 mm Dişli Threaded	*11	5,4	40,4x17,7x21,8 cm	184 €
11515124002	Storm 1.00	1,00	50 mm Dişli Threaded	*13	5,9	40,4x17,7x21,8 cm	194 €



Kripsol Pompa Serisi

Kripsol Pump Series

50 yılı aşkın geçmiřiyle Avrupa'da tanınan Kripsol pompaları, Neta Havuz güvencesiyle řimdi Türkiye'de. Geniř model yelpazesi ve dayanıklı yapısıyla havuz projelerinde sıkça tercih ediliyor.

With over 50 years of history, Kripsol pumps are well-known across Europe – now available in Turkey with the assurance of Neta Havuz. Widely preferred in pool projects for their durable construction and broad model range.



Ninfa NK



KOMPAKT GÜÇ COMPACT POWER

Küçük hacimli havuzlar için tasarlanmış, tuzlu suya dayanıklı, sessiz ve güvenilir performans.

Designed for small pools, this saltwater-resistant pump offers quiet and reliable performance.



Öne Çıkan Özellikler Product Features

- » Yer üstü veya küçük ebatlı ev havuzları için çözüm sunar
- » Kolay açılır şeffaf kapak. (Alet gerektirmez)
- » Bağlantı 2" dıştan dişli, 1 1/4" içten dişli
- » Mekanik salmastra AISI 316 kalite
- » Motor sürüş özellikleri Class F, IP55, 50 Hz
- » 35 m³'e kadar olan ev havuzlarında kullanılır
- » Tuzlu suda kullanılabilir
- » The solution for above-ground pools or small size residential pools
- » Easy-open transparent lid. (No tools required)
- » Connection thread 2" external and 1 1/4" internal
- » Mechanical seal in AISI 316 quality
- » Motor-drive specifications Class F, IP55, 50 Hz
- » Used for residential pools up to 35 m³
- » Can be used in salt water

Ölçüler Dimensions

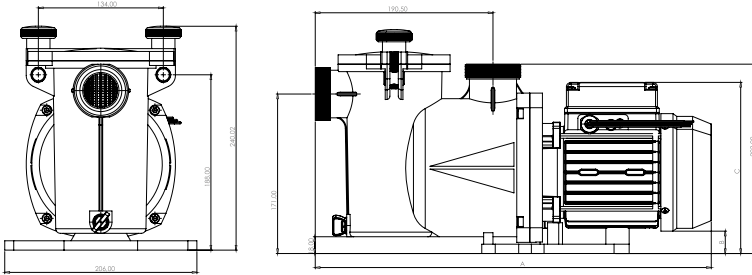

Kullanım kılavuzuna ulaşmak için QR kodu okutun.

Scan the QR code to access the user manual.



Teknik Bilgiler Technical Information

MODEL	BASMA YÜKSEKLİĞİ HEAD IN METERS									
	3	4	5	6	7	8	9	10	10,5	11
MODEL	DEBİ m ³ /h FLOW m ³ /h									
NK 25.B	8	7,3	6,7	6	5,1	4	2,1	-	-	-
NK 33.B	11	10,2	9,3	8,4	7,5	6,4	5,3	4	3,1	0
NK 51.B	13,2	12,1	11	9,75	8,6	7,5	6,1	4,3	3,4	0

*8 mss basma yüksekliğinde 8 mss water column pressure

Performans Eğrisi Performance Curves

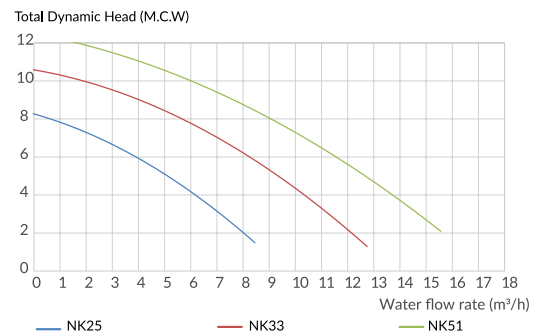

KOD CODE	MODEL MODEL	GÜÇ HP POWER HP	BAĞLANTI GİRİŞ ÇIKIŞ INLET OUTLET	DEBİ m ³ /h FLOW	GÜÇ KW POWER	AĞIRLIK Kg WEIGHT Kg	SES ŞİDDETİ SOUND	FİYAT PRICE
			Dış Outside İç Inside					
11515113054	NK 25.B	0,25	63 mm 40 mm	*4,00	0,27	5,6	51,6	275 €
11515113067	NK 33.B	0,33	63 mm 40 mm	*6,40	0,36	6	56,0	355 €
11515113076	NK 51.B	0,50	63 mm 40 mm	*7,50	0,53	6,3	59,0	380 €

Ondina OK



DAYANIKLI TASARIM ERGONOMIC BUILD

Yoğun kullanıma uygun gövdesi ve pratik taşıma yapısı ile profesyonel havuz projelerinde öne çıkar.

Durable body and ergonomic grip, ideal for demanding pool setups.

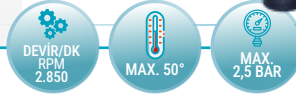

Öne Çıkan Özellikler

Product Features

- » 3" bağlantı rakorları
- » Düşmeyen gözetleme camı
- » Ergonomik ön filtre kapak anahtarı
- » Ergonomik tutma kolu sayesinde kolay taşınabilir
- » AISI 316 paslanmaz çelik mil
- » Çift boşaltma tapası
- » Tuzlu suda kullanılabilir
- » 3" connection fittings
- » Non-falling sight glass
- » Ergonomic prefilter lid key
- » Easy to carry thanks to ergonomic handle
- » AISI 316 stainless steel shaft
- » Double drain plug
- » Can be used in salt water

Kullanım kılavuzuna ulaşmak için QR kodu okutun.



Scan the QR code to access the user manual.

Ölçüler Dimensions

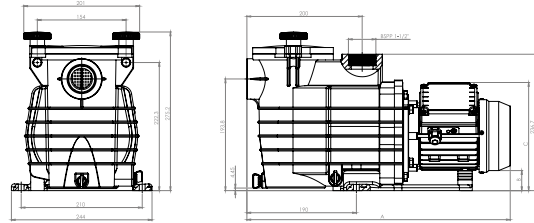

Teknik Bilgiler Technical Information

MODEL	BASMA YÜKSEKLİĞİ HEAD IN METERS						
	5	6	8	10	11	12	14
OK 33.B	9,6	8,9	7	4,8	3	-	-
OK 51.B	11	10,1	8,5	6,6	5,2	4	-
OK 71.B	13,9	13,2	11,9	10	9	7,5	3,5
OK 100.B	20	19,2	17,2	14,5	12,9	10,5	5,5

*8 mss basma yüksekliğinde 8 mss water column pressure

Performans Eğrisi Performance Curves

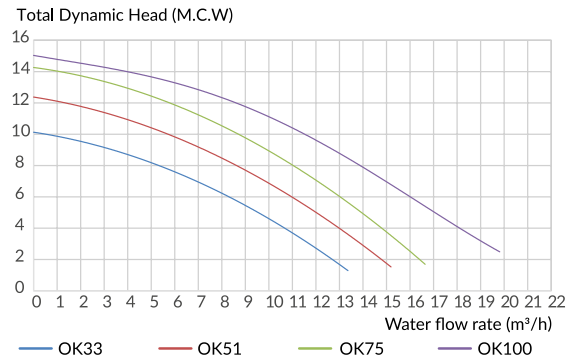

KOD CODE	MODEL MODEL	GÜÇ HP POWER HP	BAĞLANTI GİRİŞ ÇIKIŞ INLET OUTLET	DEBİ m³/h FLOW	GÜÇ KW POWER	SES ŞİDDETİ DP SOUND DP	AĞIRLIK Kg WEIGHT Kg	FİYAT PRICE
11515113083	OK 33 M	0,33	50 mm	*7,00	0,27	53,3	8	335 €
11515113084	OK 51 T	0,50	50 mm	*8,50	0,58	54,2	8,5	418 €
11515113085	OK 50 M	0,50	50 mm	*8,50	0,58	54,2	8,5	355 €
11515113086	OK 71 M	0,75	50 mm	*11,90	0,75	57,2	9	475 €
11515113087	OK 71 T1	0,75	50 mm	*11,90	0,75	57,2	9	440 €
11515113088	OK 100 M	1,00	50 mm	*17,20	1,00	59,2	11,5	540 €
11515113089	OK 100 T1	1,00	50 mm	*17,20	1,00	59,2	11,5	485 €
198114018	OK 050 IE2	0,50	50 mm	*8,50	0,58	54,2	8,5	418 €

S2 Model



AKILLI TASARIM SMARTLY ENGINEERED

Kompakt yapısı, pratik çözümleri ve güçlü performansı ile küçük havuzlara özel, kullanıcı dostu bir pompa.

Compact, practical and powerful – a user-friendly pump for small pools.



Öne Çıkan Özellikler

Product Features

- » Küçük havuzlar ve / veya yer üstü havuzları için dizayn edilmiştir
- » 80 m³e kadar olan havuzlarda kullanılır
- » Tuzlu suda kullanılabilir
- » Pump designed for small pools and /or above ground pool
- » Used for residential pools up to 80 m³
- » Can be used in salt water

Ölçüler Dimensions

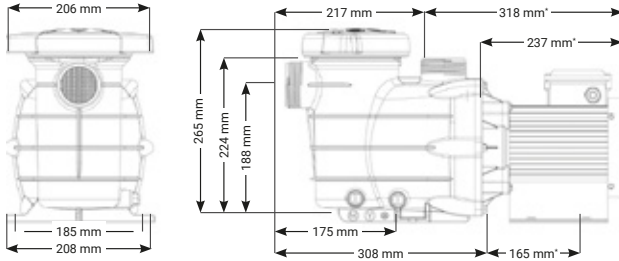

Teknik Bilgiler Technical Information

MODEL	BASMA YÜKSEKLİĞİ HEAD IN METERS					
	4	6	8	10	12	14
S2 33.M	11,2	9,4	7,3	5	2	-
S2 50.M	14,8	13	10,8	8,5	5,4	-
S2 75.M	17,4	15,2	13	11,1	7,5	-
S2 100.M	19,5	17,8	15	13,2	7,3	5,8
S2 150.M	21,2	19	17,2	15,6	11,8	7,8

*8 mss basma yüksekliğinde 8 mss water column pressure

Performans Eğrisi Performance Curves

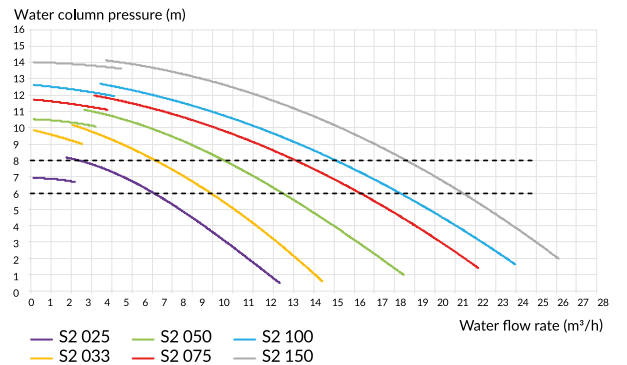

KOD CODE	MODEL MODEL	GÜÇ HP POWER HP	BAĞLANTI GİRİŞ ÇIKIŞ INLET OUTLET	DEBİ m ³ /h FLOW	GÜÇ KW POWER	AĞIRLIK Kg WEIGHT Kg	FİYAT PRICE
11515113148	S2.33 M	0,33	50 mm	*7,03	0,45	7,76	330 €
11515113146	S2.50 M	0,50	50 mm	*10,80	0,58	8,85	350 €
11515113147	S2.75 M	0,75	50 mm	*13,00	0,75	9,16	370 €
11515113150	S2.100 M	1,00	50 mm	*15,00	0,90	9,16	420 €
11515113145	S2.150 M	1,50	50 mm	*17,20	1,10	11,30	440 €

Koral KSE



KLASİK GÜÇ THE ORIGINAL POWER

Yüksek debisi, sessiz hidrolik sistemi ve farklı bağlantı seçenekleriyle her havuza uyum sağlayan klasik bir çözüm.

A quiet and powerful classic with high flow and versatile connection options for every pool.

ÖZEL AMAÇLI HAVUZ
RESIDENTIAL POOL

UZUN ÖMÜRLÜ
LONG LASTING

DÜNYA MARKASI
GLOBAL BRAND

BİR KLASİK
THE ORIGINAL



CE

DEVİR/DK
RPM
2.850

MAX. 50°

MAX.
2,5 BAR

Kullanım kılavuzuna ulaşmak için QR kodu okutun.



Scan the QR code to access the user manual.

Öne Çıkan Özellikler Product Features

- » Optimize edilmiş süper sessiz hidrolik sistem
- » Kelebek somun ile kolay kapanan şeffaf ön filtre
- » Korozyona dayanıklı fan, kolay açılabilen çift drenaj
- » Bağlantılar: \varnothing 50 veya \varnothing 63 mm yapılandırma rakorları içerir
- » Motor sürüş özellikleri Class F, IP55, 50 Hz
- » 177 m³e kadar olan havuzlarda kullanılır, Tuzlu suda kullanılabilir
- » Optimized super silent hydraulic system
- » Easy accessible and visible pre-filter
- » Corrosion resistant impeller, easy opening double drainage
- » Connections: includes slip unions for \varnothing 50 or \varnothing 63 mm
- » Motor-drive specifications Class F, IP55, 50 Hz
- » Used for residential pools up to 177 m³, Can be used in salt water

Ölçüler Dimensions

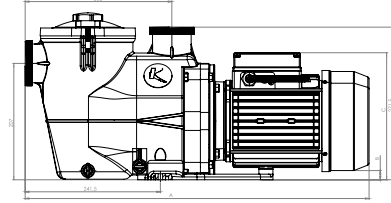
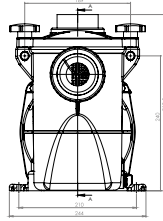

Teknik Bilgiler Technical Information

MODEL	BASMA YÜKSEKLİĞİ HEAD IN METERS								
	5	6	8	10	11	12	14	16	18
KS 33.B	11	8,9	7	4,8	3	-	-	-	-
KS 50.B	14,5	12	10	7,56	5,2	5,1	-	-	-
KS 75.B	16	14,5	13,5	11,5	10,2	8,9	5,21	-	-
KS 100.B	21,5	19,5	17,5	15,4	14,2	13	10	5,8	1
KS 150.B	27,5	25,5	23	21,9	20,8	19,7	16,4	11,8	6,2
KS 200.B	32	29,4	27,8	25,7	24,6	23,52	0,51	71	2
KS 300.B	36,5	34,5	32	29,5	28,2	26,9	23,9	20	20

Performans Eğrisi Performance Curves

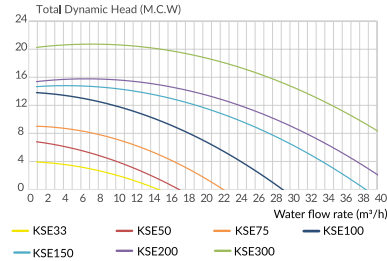

*10 mss basma yüksekliğinde
10 mss water column pressure

KOD CODE	MODEL MODEL	GÜÇ HP POWER HP	BAĞLANTI GİRİŞ ÇIKIŞ INLET OUTLET	DEBİ m³/h FLOW	GÜÇ KW POWER	SES ŞİDDETİ DP SOUND DP	AĞIRLIK Kg WEIGHT Kg	FİYAT PRICE
11515113090	KSE.33 M	0,33	63 mm	*4,08	0,45	54,6	11,2	438 €
11515113091	KSE.50 M	0,50	63 mm	*7,50	0,58	59,6	12,5	480 €
11515113092	KSE.50 T1	0,50	63 mm	*7,50	0,58	59,6	12	480 €
11515113173	KSE.75 M M IE2	0,75	63 mm	*11,50	0,75	60,8	13,5	645 €
11515113094	KSE.75 T1	0,75	63 mm	*11,50	0,75	60,8	13	625 €
11515113095	KSE.100 M	1,00	63 mm	*15,40	1,00	65,6	14	645 €
11515113096	KSE.100 T1	1,00	63 mm	*15,40	1,00	65,6	13,5	685 €
11515113097	KSE.150 M	1,50	63 mm	*21,90	1,50	65,6	16,5	725 €
11515113156	KSE.150 M IE2	1,50	63 mm	*21,90	1,50	65,6	16,5	750 €
11515113098	KSE.150 T1	1,50	63 mm	*21,90	1,50	65,6	16	755 €
11515113099	KSE.200 M	2,00	63 mm	*25,70	2,00	66,0	17,5	800 €
11515113100	KSE.200 T1	2,00	63 mm	*25,70	2,00	66,0	17	845 €
11515113165	KSE.200 T IE3	2,00	63 mm	*25,70	2,00	66,0	17,5	--
11515113132	KSE.300 T1 IE3	3,00	63 mm	*29,51	3,00	66,7	22	1.105 €
11515113159	KSE.300 M IE2	3,00	63 mm	*29,50	3,00	67,7	22	1.115 €
11515113149	KSE.300 M	3,00	63 mm	*29,50	3,00	67,7	22	1.035 €

Niger KNG



SPA UZMANI SPA SPECIALIST

Hydro masaj ve sirkülasyon sistemleri için ideal, sessiz çalışan ve tuzlu suya dayanıklı pompa.

Ideal for hydro massage and circulation systems, this silent pump performs reliably even in saltwater.



Öne Çıkan Özellikler Product Features

- » Hidro masaj, SPA ve su oyunları havuzları için sirkülasyonda kullanılır
- » Noryl fan ve AISI 316 paslanmaz mekanik salmastra
- » Kapalı tip motor koruma sınıfı IP55, class F, 50 Hz
- » Ø50 mm iç veya Ø63 mm dış yapıştırma bağlantı
- » Sessiz çalışma
- » Tuzlu suda kullanılabilir

- » Used in hydro massage, spas and general re-circulation
- » Impeller in noryl and mechanical seal in AISI 316
- » Enclosed motor, protection class IP55, class F, 50 Hz
- » Slip included: Ø50 or Ø63 mm
- » Silent operation
- » Can be used in salt water

Kullanım kılavuzuna ulaşmak için QR kodu okutun.



Scan the QR code to access the user manual.

Ölçüler Dimensions

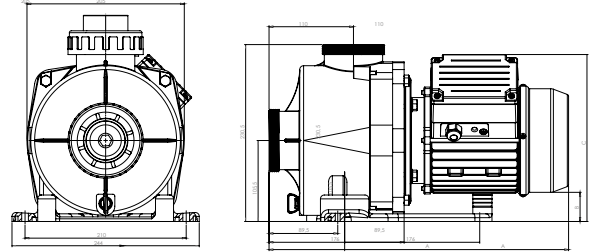

Teknik Bilgiler Technical Information

MODEL	BASMA YÜKSEKLİĞİ HEAD IN METERS								
	5	6	8	10	11	12	14	16	18
KNG 075.B	16,5	15,4	14	12	10,7	9,4	5,7	-	-
KNG 100.B	22	20	18	15,9	14,7	13,5	13,5	6,3	-
KNG 150.B	28	26	23,5	22,4	21,3	20,2	20,2	2,31	6,7
KNG 200.B	32,5	29,9	28,3	26,2	25,1	24	24	17,5	12,5

*10 mss basma yüksekliğinde 10 mss water column pressure

Performans Eğrisi Performance Curves

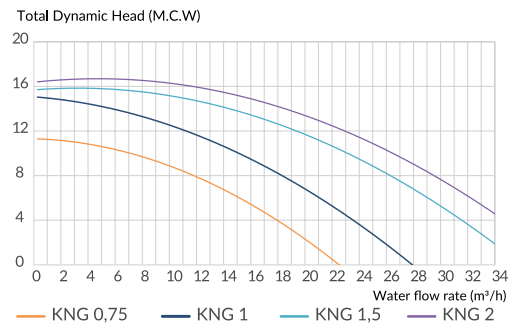

KOD CODE	MODEL MODEL	GÜÇ HP POWER HP	BAĞLANTI GİRİŞ ÇIKIŞ INLET OUTLET	DEBİ m³/h FLOW	GÜÇ KW POWER	SES ŞİDDETİ DP SOUND DP	AĞIRLIK Kg WEIGHT Kg	FİYAT PRICE
			Diş Outside İç Inside					
11515113154	KNG.075 DM	0,75	50 mm 63 mm	*12	0,75	59,4	11,5	412 €
11515113114	KNG.075 DT1	0,75	50 mm 63 mm	*12	0,75	59,4	11,5	412 €
11515113115	KNG.100 DM	1,00	50 mm 63 mm	*15,98	1,00	59,2	12	465 €
11515113117	KNG.150 DM	1,50	50 mm 63 mm	*22,4	1,60	65	14,5	513 €
11515113119	KNG.200 DM	2,00	50 mm 63 mm	*26,2	1,92	66	15,5	556 €
11515113116	KNG.100 DT1	1,00	50 mm 63 mm	*15,9	1,00	59,2	12	465 €
11515113118	KNG.150 DT1	1,50	50 mm 63 mm	*22,4	1,60	65	14,5	513 €
10771150120	KNG 150 DT1 IE3	1,50	50 mm 63 mm	*22,4	1,60	65	14,5	--
11515113120	KNG 200 DT1	2,00	50 mm 63 mm	*26,2	1,92	66	15	535 €

Kapri KAP



YÜKSEK DEBİ HIGH FLOW

Endüstriyel projeler ve büyük havuzlar için yüksek debi kapasitesi ve dayanıklılığıyla öne çıkar.

Stands out with high flow capacity and durability for industrial projects and large pools.

ÖZEL AMAÇLI HAVUZ
RESIDENTAL POOL

DÜNYA MARKASI
GLOBAL BRAND

UZUN ÖMÜRLÜ
LONG LASTING

YÜKSEK VERİMLİ
HIGH EFFICIENCY

ÖN FİLTRE KAPASİTE
PRE FILTER CAPACITY
8 LT

KATEGORİSİNDE EN İYİ
THE BEST IN ITS
CATEGORY

CE



Öne Çıkan Özellikler Product Features

- » Termoplastik enjeksiyonlu pompa gövdesi
- » Yüksek kapasiteli ön filtre
- » Şeffaf polikarbonat ön filtre kapağı. KAPRI serisinin kapağı 4 adet menteşeli kelebek somun ile kolayca kapanır
- » Noryl fan ve flanş fiberglass takviyeli
- » Motor koruma sınıfı IP55, class F, 50 Hz
- » Mekanik salmastra AISI 316 kalite
- » Tuzlu suda kullanılabilir

- » Thermoplastic injected pump casing
- » High capacity prefilter
- » Prefilter lid in transparent polycarbonate. The closing of the lid for KAPRI series is made by four hinged cover-screws with stainless steel studs
- » Impeller and flange in Noryl charged with fiber glass
- » Motor, protection class IP55, class F, 50 Hz
- » Mechanical seal in AISI 316 quality
- » Can be used in salt water

Teknik Bilgiler Technical Information

MODEL	BASMA YÜKSEKLİĞİ HEAD IN METERS							
	6	8	10	12	14	16	18	20
MODEL	DEBİ m³/h FLOW m³/h							
KAP 250.B	52	47	41	35	28	-	-	-
KAP 300.B	60	54	48	42	35	26	-	-
KAP 350.B	73	65	58	50	41	28	-	-
KAP 450.B	79	74	66	57	47	36	20	-
KAP 550.B	86	88	76	67	52	52	28	-

*10 mss basma yüksekliğinde 10 mss water column pressure

Ölçüler Dimensions

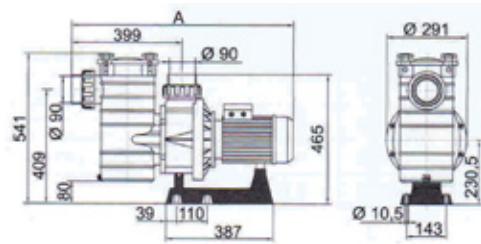

KOD CODE	MODEL MODEL	GÜÇ HP POWER HP	BAĞLANTI GİRİŞ ÇIKIŞ INLET OUTLET	DEBİ m³/h FLOW	GÜÇ KW POWER	SES ŞİDDETİ DP SOUND DP	AĞIRLIK Kg WEIGHT Kg	FİYAT PRICE
11515113102	KAP250 M.B	2,50	90 mm	*41	2,3	65,2	-	1.298 €
11515113103	KAP250 Tri	2,50	90 mm	*41	2,3	65,2	-	1.515 €
11515113104	KAP300 M	3,00	90 mm	*48	2,76	65,8	-	1.370 €
11515113105	KAP300 T1.B	3,00	90 mm	*48	2,76	68,4	-	1.530 €
11515113106	KAP350 T1.B	3,50	90 mm	*58	3,7	-	-	1.648 €
11515113053	KAP450 T1.B	4,50	90 mm	*66	4,3	-	-	1.678 €
11515113107	KAP550 T1.B	5,50	90 mm	*76	4,71	-	-	1.750 €

Karpa KA



JET PERFORMANSI JET PERFORMANCE

Jet stream, spa ve büyük havuzlarda yüksek debiyle sessiz ve güçlü sirkülasyon sağlar.

Provides powerful and silent circulation with high flow for jet streams, spas, and large pools.



Öne Çıkan Özellikler Product Features

- » Kullanım Alanları: Hidromasaj havuzları, spalar, jet stream ve genel havuzlar için sirkülasyon
- » Sessiz çalışma
- » Motor sürüş özellikleri Class F, IP55, 50 Hz
- » Mekanik salmastra AISI 316 kalite
- » Pompa gövdesi sertleştirilmiş yapıda
- » Tuzlu suda kullanılabilir

- » Usage Areas: Hydromassage pools, spas, jet stream and circulation for public pools
- » Silent operation
- » Motor-drive specifications Class F, IP55, 50 Hz
- » Mechanical seal in AISI 316 quality
- » Pump housing in hardened thermoplastic
- » Can be used in salt water

Kullanım kılavuzuna ulaşmak için QR kodu okutun.



Scan the QR code to access the user manual.

Ölçüler Dimensions

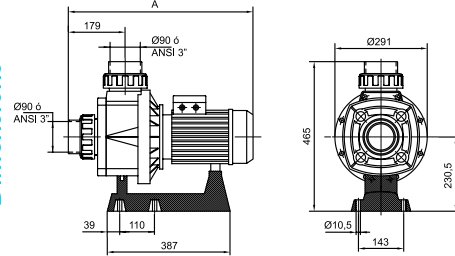

Teknik Bilgiler Technical Information

MODEL	BASMA YÜKSEKLİĞİ HEAD IN METERS							
	6	8	10	12	14	16	18	20
KA 250.B	54	50	44	39	30	00	-	-
KA 300.B	60	54	48	42	37	20	-	-
KA 350.B	78	71	63	54	45	21	-	-
KA 450.B	84	76	67	58	47	27	-	-
KA 550.B	93	85	78	68	59	47	30	-

*10 mss basma yüksekliğinde 10 mss water column pressure

Performans Eğrisi Performance Curves

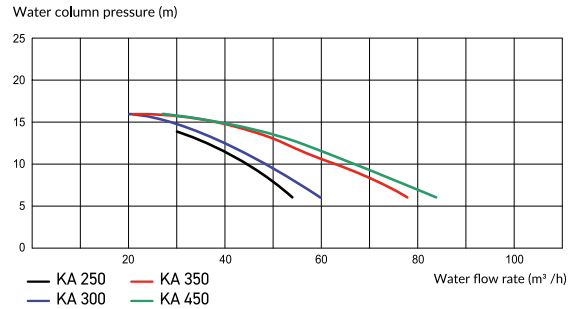

KOD CODE	MODEL MODEL	GÜÇ HP POWER HP	BAĞLANTI GİRİŞ ÇIKIŞ INLET OUTLET	DEBİ m ³ /h FLOW	GÜÇ KW POWER	SES ŞİDDETİ DP SOUND DP	AĞIRLIK Kg WEIGHT Kg	FİYAT PRICE
11515113121	KA 250.B M	2,50	90 mm	*44	2,3	65,2	20,8	1.140 €
11515113122	KA 250.B T1	2,50	90 mm	*44	2,3	65,2	20,8	1.120 €
11515113123	KA 300.B M	3,00	90 mm	*48	2,76	65,8	21,5	1.210 €
11515113124	KA 300.B T1	3,00	90 mm	*48	2,76	65,8	21,5	1.170 €
11515113125	KA 350.B T1	3,50	90 mm	*63	3,7	65,4	-	1.230 €
11515113126	KA 450.B T1	4,50	90 mm	*67	4,3	-	-	1.290 €
11515113127	KA 550.B T1	5,50	90 mm	*78	4,71	-	-	1.350 €
11515113128	KA 550.B T2	5,50	90 mm	*78	4,71	-	-	1.350 €

Prime KPR



GENİŞ KAPASİTE LARGE CAPACITY

Büyük hacimli havuzlar için güçlü ve uzun ömürlü pompa.

Powerful and long-lasting pump for large-volume pools.

ÖZEL AMAÇLI VE
KÜÇÜK TİCARİ HAVUZ
RESIDENTIAL &
SMALL COMMERCIAL
POOL

DÜNYA MARKASI
GLOBAL BRAND

UZUN ÖMÜRLÜ
LONG LASTING

GÜÇLÜ & ÇOK YÖNLÜ
POWERFUL & VERSATILE

ÖN FİLTRE KAPASİTE
PRE FILTER CAPACITY
5 LT

YÜKSEK VERİMLİ
HIGH EFFICIENCY

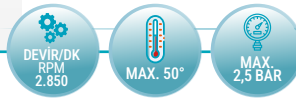

Öne Çıkan Özellikler Product Features

- » Büyük konut havuzları veya küçük ticari havuzlarda, su terapisi jetlerinde kullanılır
- » Büküm kilit sistemi sayesinde kolay kapanır ve geniş açılı şeffaf ön filtre kapağı
- » Noryl fan ve AISI 316 paslanmaz mekanik salmastra
- » Sağlam, korozyona dayanıklı tasarım
- » 270 m³'e kadar olan konut havuzlarında kullanılır
- » Tuzlu suda kullanılabilir

- » Used in large residential pools or small public pools and in aqua therapy jets
- » The transparent cover with a rapid twist-lock cover provides a view into the interior of the pre filter and provides easy access
- » Impeller in Noryl and mechanical seal in AISI 316
- » Robust, corrosion-resistant design
- » For residential pools up to 270 m³
- » Can be used in salt water

Ölçüler Dimensions

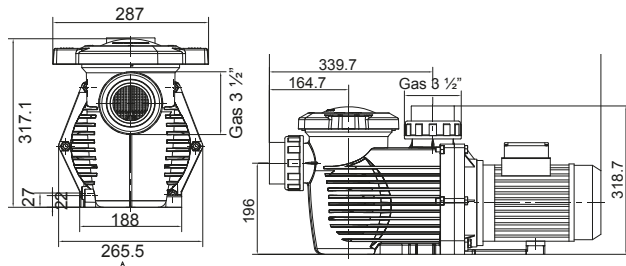

Kullanım kılavuzuna ulaşmak için QR kodu okutun.

Scan the QR code to access the user manual.



Büküm kilit kapağı
Twist lock cover



Rakor ø75 mm
yapıştırma
Union ø75 mm slip



5 Litreden fazla ön filtre kapasitesi
More than 5 liter strainer

Teknik Bilgi Technical Information

MODEL	BASMA YÜKSEKLİĞİ HEAD IN METERS										
	6	8	10	12	14	16	18	20	22	24	26
KPR 250.B	36	33	30	26	24	19	16	10	3	-	-
KPR 300.B	40	38	36	34	32	28	25	62	16	6	-
KPR 350.B	49	47	45	43	41	38	35	2	27	21	10

*10 mss basma yüksekliğinde 10 mss water column pressure

Performans Eğrisi Performance Curves

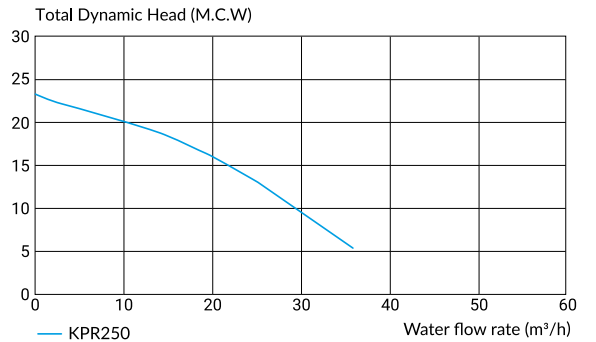

KOD CODE	MODEL MODEL	GÜÇ HP POWER HP	BAĞLANTI GİRİŞ ÇIKIŞ INLET OUTLET	DEBİ m³/h FLOW	GÜÇ KW POWER	SES ŞİDDETİ DP SOUND DP	AĞIRLIK Kg WEIGHT Kg	FİYAT PRICE
11515113143	KPR.250 M	2,50	75 mm	*30	2,4	-	24	865 €
11515113142	KPR.250 T1	2,50	75 mm	*30	2,4	-	28,5	784 €
11515113139	KPR.300 M	3,00	75 mm	*36	2,8	-	26	879 €
11515113138	KPR.300 T1	3,00	75 mm	*36	2,8	-	28,5	827 €
11515113140	KPR.350 T1	3,50	75 mm	*45	3,8	-	31,5	898 €

Kan Plus

AĞIR HİZMET PERFORMANSI HEAVY-DUTY PERFORMANCE

Yüksek debili ticari havuzlar için güçlü ve dayanıklı çözüm.

Powerful and durable solution for high-flow commercial pools.

TİCARİ HAVUZ
COMMERCIAL POOL

UZUN ÖMÜRLÜ
LONG LASTING

DÜNYA MARKASI
GLOBAL BRAND

YÜKSEK VERİMLİ
HIGH EFFICIENCY

ÖN FİLTRE KAPASİTE
PRE FILTER CAPACITY
14 LT

CE



MADE IN
SPAIN



Öne Çıkan Özellikler Product Features

- » Termoplastik plastik enjeksiyonlu pompa gövdesi
- » Yüksek kapasiteli ön filtre
- » Şeffaf polikarbonat ön filtre kapağı
- » KAN serisinin kapağının kapatılması, paslanmaz çelik saplamalı dört menteşeli kapak vidası ile sağlanmıştır.
- » 3 Kg/cm² basınca dayanabilen desteklenmiş pompa gövdesi, kapak ve pim
- » Noryl fan ve AISI 316 paslanmaz mekanik salmastra
- » Motor koruma sınıfı IP55, class F, 50 Hz
- » Tuzlu suda kullanılabilir
- » Thermoplastic plastic injected pump casing
- » High capacity prefilter
- » Prefilter lid in transparent polycarbonate
- » The closing of the lid for KAN series is made by four hinged cover-screws with stainless steel studs
- » Pump casing, lid and pin reinforced to reach 3 Kg/cm² working pressure
- » Impeller in Noryl and mechanical seal in AISI 316
- » Motor, protection class IP55, class F, 50 Hz
- » Can be used in sea water

Teknik Bilgiler Technical Information

MODEL	BASMA YÜKSEKLİĞİ HEAD IN METERS									
	8	10	11	12	13	14	16	18	20	22
KAN 500.B	90	80	72	64	56	47,5	39,9	22,6	-	-
KAN 600.B	94,5	90	87	84,2	80	75,5	59	46,2	36	-
KAN 750.B	122	113	108	102	95	89	74	53	36,5	-
KAN 1000.B	135	125,4	120,4	115,6	110,5	105,5	83,9	57	32,5	-
KAN 1250.B	152	143	140	137	126	47	118	106	93	80

*10 mss basma yüksekliğinde 10 mss water column pressure

Ölçüler Dimensions

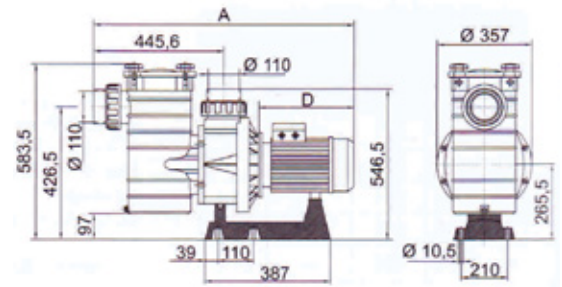

KOD CODE	MODEL MODEL	GÜÇ HP POWER HP	BAĞLANTI GİRİŞ ÇIKIŞ INLET OUTLET	DEBİ m ³ /h FLOW	GÜÇ KW POWER	SES ŞİDDETİ DP SOUND DP	AĞIRLIK Kg WEIGHT Kg	FİYAT PRICE
11515113108	KAN 510 T2B	5,50 Tri	110 mm	*80	5,5	80	45	1.778 €
11515113109	KAN 610 T2B	6,50 Tri	110 mm	*90	6,5	82	46	2.018 €
11515113110	KAN 760 T2B	7,50 Tri	110 mm	*113	7,5	85	52	2.990 €
11515113111	KAN 1020 T2B	10,0 Tri	110 mm	*125	10	87	66	3.100 €
11515113112	KAN 1270 T2B	12,50 Tri	110 mm	*143	12,5	87	76	3.039 €
11515113155	KAN 1020 T2B IE3	10,00 Tri	110 mm	*125	10	87	66	3.475 €
11515113160	KAN 1270 T2B IE3	12,50 Tri	110 mm	*143	12,5	87	76	3.850 €

KSE-VS 150



AKILLI PERFORMANS SMART PERFORMANCE

Sessiz, verimli ve programlanabilir havuz pompası.

Silent, efficient and programmable pool pump.



ÖZEL AMAÇLI VE
KÜÇÜK TİCARİ HAVUZ
RESIDENTIAL %
SMALL COMMERCIAL
POOL

DÜNYA MARKASI
GLOBAL BRAND

UZUN ÖMÜRLÜ
LONG LASTING

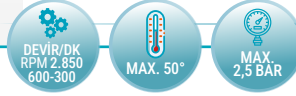

Öne Çıkan Özellikler Product Features

- » Değişken hız: Her uygulama için yüksek verim, optimize edilmiş tüketim
- » 5 program, 3 önceden seçilmiş hız
- » Süper sessiz çalışma
- » Dahili ön filtrenin görünürlüğü, kolay erişim
- » Noryl® marka çok sağlam ve korozyona dayanıklı fan ve difüzör
- » Çift tahliye, kolay açılabilir kapak (alet gerektirmez)
- » Bağlantılar: ANSI 1½-2", Ø50 ve Ø63 mm yapıştırma rakorlar
- » 126 m³'e kadar olan havuzlarda kullanılır
- » Tuzlu suda kullanılabilir
- » Variable speed: high efficiency for each application, optimised consumption
- » 5 programs, 3 preselected speeds
- » Super-silent operation
- » Visibility of the internal prefilter, easy access
- » Impeller and diffuser made of Noryl very hard-wearing and corrosion-resistant
- » Double drain, easy opening (no tools required)
- » Connections: ANSI 1½-2", includes slip unions for Ø50 and Ø63 mm
- » Usage: for residential pools up to 126 m³
- » Suitable for use in salt water

50 ve 63 mm çapındaki rakor bağlantı parçaları sağlanır; mevcut herhangi bir kurulumla uyum sağlamak üzere tasarlanmıştır.

Union fittings provided, 50 and 63 mm diameter, to fit in any existing installation



Performans Eğrisi Performance Curves

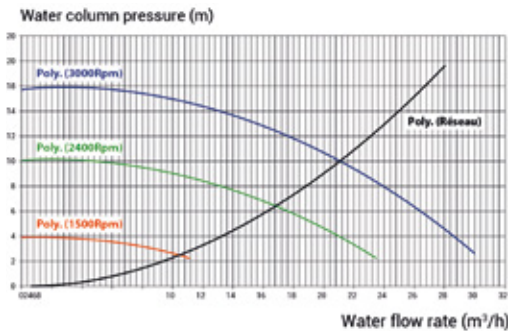

*10 mss basma yüksekliğinde 10 mss water column pressure

Ölçüler Dimensions

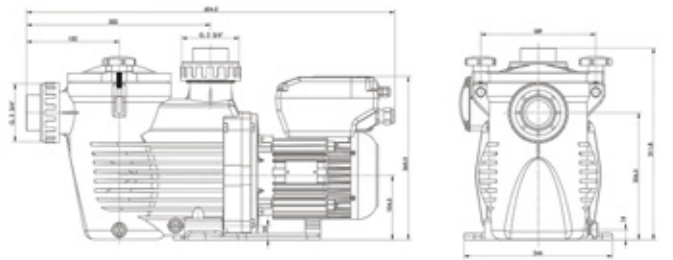

KOD CODE	MODEL MODEL	GÜÇ HP POWER HP	BAĞLANTI GİRİŞ ÇIKIŞ INLET OUTLET	DEBİ m³/h FLOW	GÜÇ KW POWER	SES ŞİDDETİ DP SOUND DP	AĞIRLIK Kg WEIGHT Kg	FİYAT PRICE
11515113151	KSE VS 150	1,5	Ø50 - Ø60	*21	1,24	-	15	1.800 €



Hayward Pompa Serisi *Hayward Pump Series*



Dünyaca Ünlü Hayward Artık Neta Havuz'da

Neredeyse bir asırlık tecrübeye sahip Hayward, havuz teknolojilerinde kalite ve güvenin simgesidir. Artık Neta Havuz güvencesiyle Türkiye'de, sessiz, verimli ve uzun ömürlü pompa çözümleriyle profesyonel ve özel projelerde fark yaratıyor.

The World-Renowned Hayward, Now at Neta Havuz

With nearly a century of expertise, Hayward stands for quality and reliability in pool technology. Now available in Turkey with Neta Havuz's assurance, Hayward offers quiet, efficient, and long-lasting pump solutions for both professional and residential pools.



HCP 3600

VERİMLİ PERFORMANS EFFICIENT PERFORMANCE

Büyük havuz, spa ve su oyunları için yüksek verimli ve kolay kurulabilen termoplastik pompa.
High-efficiency, easy-to-install thermoplastic pump for large pools, spas, and water features.

TİCARİ HAVUZ
COMMERCIAL POOL

DÜNYA MARKASI
GLOBAL BRAND

UZUN ÖMÜRLÜ
LONG LASTING

GÜÇLÜ & ÇOK YÖNLÜ
POWERFUL & VERSATILE

YÜKSEK VERİMLİ
HIGH EFFICIENCY

CE



MADE IN
SPAIN



Öne Çıkan Özellikler Product Features

- » Cam elyaf takviyeli termoplastikten üretilmiş gövde
- » Hafif ve kolay monte edilebilir yapı
- » IE3 standartlarına uygun üç fazlı motor
- » Takviyeli Noryl malzemeden türbin
- » Tuzlu ve deniz suyunda kullanım imkânı
- » Kolay bakım için şeffaf kapaklı ön filtre
- » Twist-lock kapak, 75 mm çaplı rakor bağlantılarıyla birlikte
- » 50 Hz / 2.850 rpm, IP55, sınıf F izolasyonu
- » Talep üzerine ANSI bağlantı seçeneği

- » Housing made of glass-fibre reinforced thermoplastic
- » Lightweight and easy to install
- » Three-phase motor compliant with IE3 standard
- » Impeller made of reinforced Noryl
- » Suitable for salt water and sea water
- » Strainer with transparent cover for easy maintenance
- » Twist-lock cover includes 75 mm diameter socket unions
- » 50 Hz / 2,850 rpm, IP55, class F insulation
- » ANSI connection option available on request

Ölçüler Dimensions

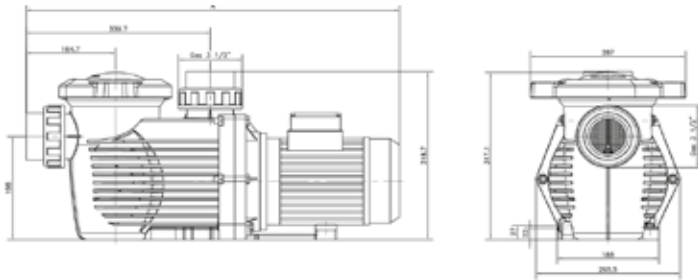

Performans Eğrisi Performance Curves

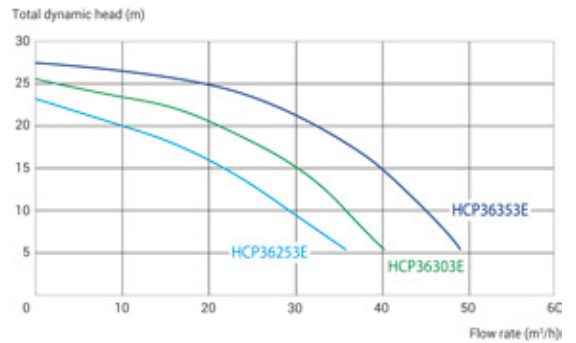

Teknik Bilgiler Technical Information

	MOTOR GÜCÜ TYPE HP	BOYUT A DIM A	AĞIRLIK WEIGHT	BAĞLANTI ÇAPI Ø FITTING Ø	DEBİ FLOW RATE	MAX GÜÇ TÜKETİMİ (W) P1 MAX (W) (Max consumption of the pump)	MAX AKIM (A) AMPS AT P1 MAX (A)
MONFAZE SINGLE PHASE	2,5	669 mm	27 kg	75 mm	40 m³/h	2200	10.7
	3	669 mm	27 kg	75 mm	43 m³/h	2600	12.6
TRİFAZE THREE PHASE	2,5	669 mm	28,5 kg	75 mm	30 m³/h	2400	8.3 / 4.8
	3	669 mm	28,5 kg	75 mm	36 m³/h	2800	8.8 / 5.1
	3,5	710 mm	31,5 kg	75 mm	45 m³/h	3800	12.1 / 7

*10 mss basma yüksekliğinde 10 mss water column pressure

Kullanım kılavuzuna ulaşmak için QR kodu okutun.

Scan the QR code to access the user manual.



KOD CODE	MODEL MODEL	GÜÇ HP POWER HP	BAĞLANTI GİRİŞ ÇIKIŞ INLET OUTLET	DEBİ m³/h FLOW	GÜÇ KW POWER	YETERLİLİK EFFICIENCY	AĞIRLIK Kg WEIGHT Kg	FİYAT PRICE
11515113161	HCP36251E	2,50 Tri	75 mm	*30	2,4	IE1	24	1.150 €
11515113158	HCP36301E	3,00 Tri	75 mm	*36	2,8	IE1	26	1.175 €
11515113157	HCP36353E	3,50 Tri	75 mm	*36	3,4	IE3	27	1.475 €

HCP 3800

INDUSTRIAL POWER ENDÜSTRİYEL GÜÇ

Büyük havuzlar, spa ve su oyunları için yüksek performanslı termoplastik pompa.
High-performance thermoplastic pump for large pools, spas, and water features.

TİCARİ HAVUZ
COMMERCIAL POOL

DÜNYA MARKASI
GLOBAL BRAND

UZUN ÖMÜRLÜ
LONG LASTING

GÜÇLÜ & ÇOK YÖNLÜ
POWERFUL & VERSATILE

YÜKSEK VERİMLİ
HIGH EFFICIENCY

CE



MADE IN
SPAIN



Öne Çıkan Özellikler Product Features

- » Hafif yapısı sayesinde kolay taşınır ve monte edilir.
- » Cam elyaf takviyeli termoplastikten üretilmiş gövde.
- » IE3 standartlarına uygun üç fazlı motor.
- » Takviyeli Noryl malzemeden üretilmiş türbin.
- » Tuzlu ve deniz suyunda kullanıma uygun.
- » Kolay bakım için şeffaf kapaklı ön filtre.
- » Motorun doğru havalandırması için yükseltilmiş taban.
- » 50 Hz / 2.850 rpm, IP55, sınıf F izolasyon.
- » Talep üzerine ANSI bağlantı seçeneği.

- » Lightweight for easy transport and installation
- » Housing made of glass-fibre reinforced thermoplastic
- » Three-phase motor compliant with IE3 standard
- » Impeller made of reinforced Noryl
- » Suitable for salt water and sea water
- » Strainer with transparent lid for easy maintenance
- » Elevated base for proper motor ventilation
- » 50 Hz / 2,850 rpm, IP55, class F insulation
- » ANSI connection option available on request

Ölçüler Dimensions

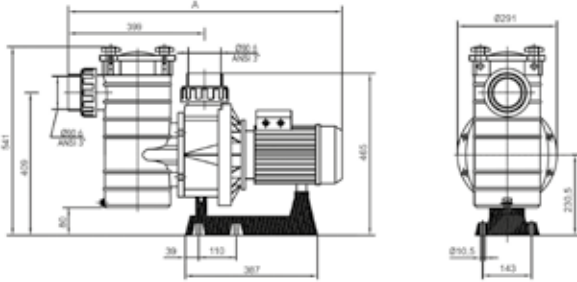

Performans Eğrisi Performance Curves

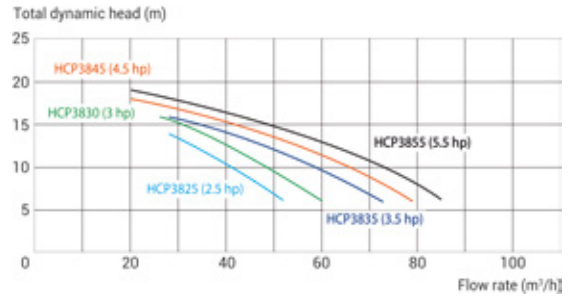

Teknik Bilgiler Technical Information

REFERANS REFERENCE	GÜÇ HP P2 HP	GÜÇ KW P1 KW	DEBİ FLOW RATE	GİRİŞ-ÇIKIŞ INLET OUTLET	MOTOR MOTOR	AKIM (A) AMPERAGE	BOYUT (A) DIM (A)	PAKET ÖLÇÜ PACKAGING DIM	PALET BAŞI- NA ADET QTY. PER PALLET (UDS)
HCP38553E1	5.5	4.7	67 m³/h	90 mm	Three-phase 230 / 400 V	14.6 / 8.5	815 mm	830 x 330 x 570	12

*12 m su kolon basıncı altında / P1: Giriş Gücü / P2: Nominal Güç
Temmuz 2023 itibarıyla monofaze pompalar için IE2 motorlu yeni modeller mevcut olacaktır.

* under 12 m water column pressure / P1: Power input / P2: Nominal Power
New references with IE2 motor will be available from July 2023 for single-phase pumps.

Kullanım kılavuzuna ulaşmak için QR kodu okutun.



Scan the QR code to access the user manual.

KOD CODE	MODEL MODEL	GÜÇ HP POWER HP	BAĞLANTI GİRİŞ ÇIKIŞ INLET OUTLET	DEBİ m³/h FLOW	GÜÇ KW POWER	YETERLİLİK EFFICIENCY	AĞIRLIK Kg WEIGHT Kg	FİYAT PRICE
11515113131	HCP3855	5,50 Tri	90 mm	*67	4,7	IE1	35,5	1.750 €

HCP 4000

YÜKSEK KAPASİTE HIGH CAPACITY

Çok büyük havuzlar, spa ve su göstere-
rileri için tasarlanmış yüksek kapasite-
li termoplastik pompa.

High-capacity thermoplastic pump
designed for very large pools, spas, and
water features.



TİCARİ HAVUZ
COMMERCIAL POOL

DÜNYA MARKASI
GLOBAL BRAND

YÜKSEK VERİMLİ
HIGH EFFICIENCY

UZUN ÖMÜRLÜ
LONG LASTING

CE



MADE IN
SPAIN



Öne Çıkan Özellikler Product Features

- » Kendinden emişli santrifüj pompa, cam elyaf takviyeli termoplastik gövde
- » Hafif yapısı sayesinde kolay taşınır ve monte edilir
- » IE3 standartlarına uygun üç fazlı motor
- » Yüksek performanslı hidrolik sistem
- » Takviyeli Noryl malzemeden üretilmiş türbin
- » Tuzlu ve deniz suyunda kullanıma uygun
- » Yüksek performanslı TEFC motor
- » Kolay bakım için 14 litrelik şeffaf kapaklı ön filtre
- » Motorun doğru havalandırması için yükseltilmiş taban
- » 50 Hz / 2.850 rpm, IP55, sınıf F izolasyon
- » Talep üzerine ANSI bağlantı seçeneği

- » Self-priming centrifugal pump with glass-fibre reinforced thermoplastic housing
- » Lightweight for easy transport and installation
- » Three-phase motor compliant with IE3 standard
- » High-performance hydraulics
- » Impeller made of reinforced Noryl
- » Suitable for salt water and sea water
- » High-performance TEFC motor
- » 14 L transparent cover strainer for easy maintenance
- » Elevated base for proper motor ventilation
- » 50 Hz / 2,850 rpm, IP55, class F insulation
- » ANSI connection option available on request

Kullanım kılavuzuna ulaşmak için QR kodu okutun.



Scan the QR code to access the user manual.

Ölçüler Dimensions

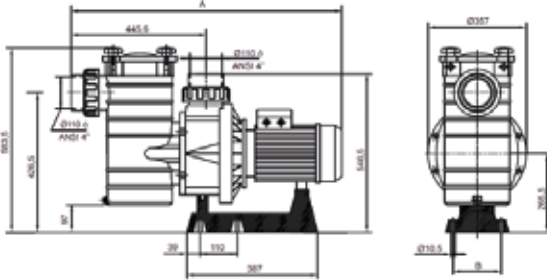

Performans Eğrisi Performance Curves

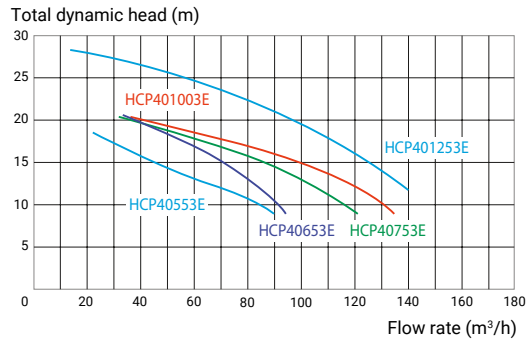

Teknik Bilgiler Technical Information

REFERANS REFERENCE	GÜÇ HP P2 HP	GÜÇ KW P1 KW	DEBİ FLOW RATE	GİRİŞ-ÇIKIŞ INLET OUTLET	MOTOR MOTOR	AKIM (A) AMPERAGE	BOYUT (A) DIM (A)	PAKET ÖLÇÜ PACKAGING DIM	PALET BAŞI- NA ADET QTY. PER PALLET (UDS)
HCP401253E	12.5	10.2	124 m³/h	110 mm	Three-phase 400 / 700 V	18,0 / 10,4	984 mm	940 x 390 x 620	3

KOD CODE	MODEL MODEL	GÜÇ HP POWER HP	BAĞLANTI GİRİŞ ÇIKIŞ INLET OUTLET	DEBİ m³/h FLOW	GÜÇ KW POWER	YETERLİLİK EFFICIENCY	AĞIRLIK Kg WEIGHT Kg	FİYAT PRICE
11515113113	HCP401253E	12.50 Tri	110 mm	*137	10,2	IE3	76	3.850 €

HCP 4200



DENGELİ PERFORMANS BALANCED PERFORMANCE

1.450 rpm motoru ve takviyeli yapısıyla yüksek performans, düşük gürültü.

With its 1,450 rpm motor and reinforced design, it delivers high performance with low noise.



TİCARİ HAVUZ
COMMERCIAL POOL

DÜNYA MARKASI
GLOBAL BRAND

YÜKSEK VERİMLİ
HIGH EFFICIENCY

UZUN ÖMÜRLÜ
LONG LASTING



Öne Çıkan Özellikler Product Features

- » Cam elyaf takviyeli termoplastikten üretilmiş gövde
- » IE3 standartlarına uygun üç fazlı motor
- » Takviyeli Noryl malzemeden türbin
- » 4 kutuplu motor (1.450 rpm / 50 Hz)
- » Tuzlu ve deniz suyu kullanılabılır
- » 14 litrelik yüksek kapasiteli, şeffaf kapaklı ön filtre
- » Yükseltilmiş taban, motor havalandırmasını optimize eder
- » Talep üzerine ANSI bağlantı seçeneği

- » Housing made of glass-fibre reinforced thermoplastic
- » Three-phase motor compliant with IE3 standard
- » Impeller made of reinforced Noryl
- » 4-pole motor operating at 1,450 rpm / 50 Hz
- » Suitable for salt and sea water
- » 14 L transparent strainer cover for easy maintenance
- » Elevated base ensures optimal motor ventilation
- » ANSI connection option available on request

Ölçüler Dimensions

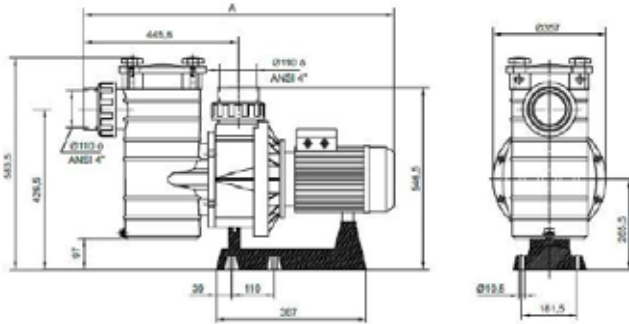

Performans Eğrisi Performance Curves

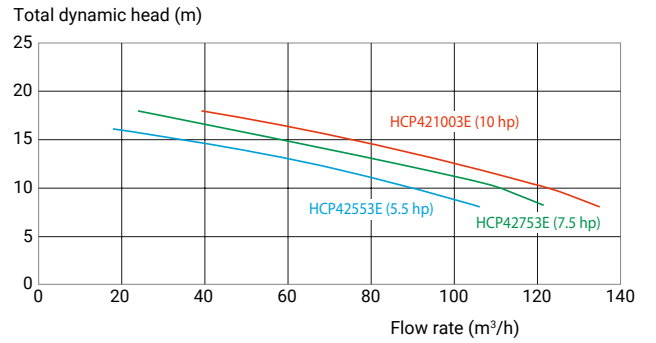

KOD CODE	MODEL MODEL	GÜÇ HP POWER HP	BAĞLANTI GİRİŞ ÇIKIŞ INLET OUTLET	DEBİ m³/h FLOW	GÜÇ KW POWER	YETERLİLİK EFFICIENCY	AĞIRLIK Kg WEIGHT Kg	FİYAT PRICE
11515113175	HCP42553E	5.50	110 mm	*68	4.71	IE3	46	--
11515113176	HCP42753E	7.50	110 mm	*90	7.00	IE3	50	--
11515113177	HCP421003E	10.00	110 mm	*104	8.70	IE3	70	--

HAYWARD & KRIPSOL MOTORLARI YENİ DÜZENLEME ENERJİ VERİMLİLİĞİ STANDARTLARI

(EU) 2019/1781 Komisyon Düzenlemesi

HAYWARD & KRIPSOL PUMPS ENERGY EFFICIENCY STANDARDS

Commission Regulation (EU) 2019/1781

Yürürlüğe Giriş Tarihleri

1 Temmuz 2021 itibariyle

- Nominal gücü 0,75 kW (1 HP) ve 1000 kW (1341 HP) arasında olan, 2 veya 4 kutuplu üç fazlı motorlar en az IE3 verimlilik seviyesinde olmalıdır.
- Nominal gücü 0,12 kW (0,16 HP) ile 0,75 kW (1 HP) arasında olan üç fazlı motorlar en az IE2 verimlilik seviyesinde olmalıdır.

1 Temmuz 2023 itibariyle

- 0,12 kW (0,16 HP) ve üzeri nominal güce sahip monofaze motorlar IE2 verimlilik sınıfına geçmiştir.

Effective Dates

From 1st July 2021

- Three-phase motors with a rated output between 0.75 kW (1 HP) and 1000 kW (1341 HP), with 2 or 4 poles, must meet at least the IE3 efficiency level.
- Three-phase motors with a rated output between 0.12 kW (0.16 HP) and 0.75 kW (1 HP) must meet at least the IE2 efficiency level.

From 1st July 2023

- Single-phase motors with a rated output equal to or above 0.12 kW (0.16 HP) are now upgraded to the IE2 efficiency class in compliance with the new directive.

KUTUPLAR POLES

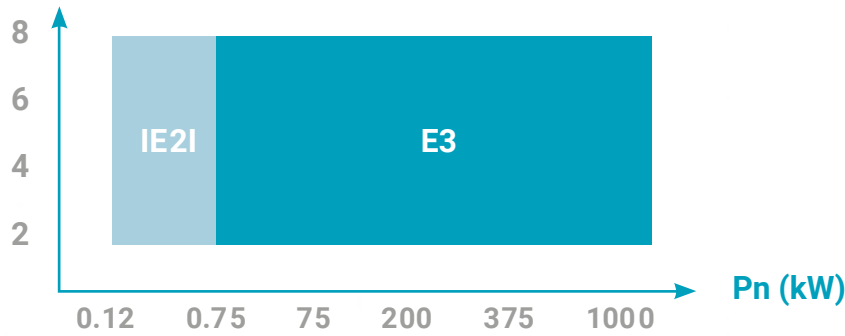

Tablo2 Table 2

Yeni düzenleme Hayward ve Kripsol motorlarını nasıl etkiler?

How Does the New Regulation Affect Hayward and Kripsol Pumps?

Hayward®, tüm ürünlerini Avrupa Parlamentosu ve Konseyi tarafından belirlenen enerji verimliliği standartlarına uygun olarak tasarlamakta ve üretmektedir.

Yeni yönetmeliklere uygun olarak, tüm Hayward® pompaları IE2 veya IE3 motor verimlilik sınıfları ile sunulacaktır.

Hayward and Kripsol designs and manufactures all pool equipment in compliance with EU energy efficiency standards. As part of ongoing product development, Hayward® pumps are now offered with IE2 or IE3 energy-rated motors, ensuring higher performance and sustainability.

Kontrol Panoları

Control Panels

Lüks Seri

Lux Series

Öne Çıkan Özellikler

Product Features

Kaçak akım rölesi ve motor faz koruması tüm panolarda fiyatlara dahildir
Leakage current relay and motor phase protection are included in all panels



KOD CODE	AÇIKLAMA DESCRIPTION	FİYAT PRICE
15015122029	1 Pompa+1 Grup Lamba Monofaze 1 Pump+1 Group Lamp Single Phase	270 €
15015122030	1 Pompa+1 Grup Lamba Trifaze 1 Pump+1 Group Lamp Three Phase	360 €
15015122031	2 Pompa+2 Grup Lamba Monofaze 2 Pump+2 Group Lamp Single Phase	408 €
15015122032	2 Pompa+2 Grup Lamba Trifaze 2 Pump+2 Group Lamp Three Phase	534 €
15015122027	3 Pompa+1 Grup Lamba Monofaze 3 Pump+1 Group Lamp Single Phase	576 €
15015122028	3 Pompa+1 Grup Lamba Trifaze 3 Pump+1 Group Lamp Three Phase	702 €

Zaman Röleli

With Timer

Öne Çıkan Özellikler

Product Features

- » Korozyona karşı dayanıklı gövde
- » CE belgeli şalt malzemesi
- » 1 pompa, 1 grup lamba; 1 adet 3 HP'ye kadar pompa ve 1 grup 300 Watt'a kadar lambayı kontrol eder
- » 2 pompa, 2 grup lamba; 2 adet 3 HP'ye kadar pompa ve 2 grup 300 Watt'a kadar lambayı kontrol eder
- » Corrosion resistant housing
- » CE certified circuit
- » 1 pcs pump, 1 group lamp controls up to 1 pcs 3 HP pump and 1 group 300 Watt lamp
- » 2 pcs pump, 2group lamp controls up to 2 pcs 3 HP pump and 2 group 300 Watt lamp



KOD CODE	AÇIKLAMA DESCRIPTION	FİYAT PRICE
15015122033	1 Pompa+1 Grup Lamba Monofaze 1 Pump+1 Group Lamp Single Phase	330 €
15015122034	1 Pompa+1 Grup Lamba Trifaze 1 Pump+1 Group Lamp Three Phase	420 €
15015122035	2 Pompa+2 Grup Lamba Monofaze 2 Pump+2 Group Lamp Single Phase	488 €
15015122036	2 Pompa+2 Grup Lamba Trifaze 2 Pump+2 Group Lamp Three Phase	594 €
15015122046	3 Pompa+3 Grup Lamba Monofaze 3 Pump+3 Group Lamp Single Phase	636 €
15015122047	3 Pompa+3 Grup Lamba Trifaze 3 Pump+3 Group Lamp Three Phase	762 €

Senkron Smart Dalgıç Pompa

Senkron Smart Submersible Pump

Öne Çıkan Özellikler Product Features

- » Aşırı ısınma koruma rölesi ile güvenli ve güvenilir çalışma
- » Gizli flatör
- » 10 m³/h debi
- » Bakır sargı elektrik motoru
- » Kirden sıkışmayan flatör sistemi
- » Tek kademeli
- » Safe and reliable operation with overheat protection relay
- » Hidden floater
- » Flow rate of 10 m³/h
- » Copper wounded electric motor
- » Floater system not jammed from dirt
- » Single stage

Kullanım kılavuzuna ulaşmak için QR kodu okutun.

Scan the QR code to access the user manual.



KOD CODE	AÇIKLAMA DESCRIPTION	GÜÇ POWER	DEBİ L/H FLOW L/H	BASMA YÜKSEKLİĞİ HEAD	KABLO CABLE	VOLTAJ VOLTAGE	FİYAT PRICE
19810123080	Dalgıç Pompa Submersible Pump	550W	10.000	8,5 mt	10 mt	220V/50Hz	110 €
11516262039	Havuz Örtüsü Dalgıç Pompası Submersible Pump for Pool Cover	0,55 kW	10.000	8,5 mt	10 mt	220V/50Hz	150 €

Trione Dalgıç Pompa

Trione Submersible Pump

Öne Çıkan Özellikler Product Features

- » Aşırı ısınma koruma rölesi ile güvenli ve güvenilir çalışma
- » Gizli flatör
- » 10 m³/h debi
- » Alüminyum sargı elektrik motoru ve dolayısıyla piyasanın en uygun fiyatlı dalgıç pompası
- » Tek kademeli
- » Safe and reliable operation with overheat protection relay
- » Hidden floater
- » Flow rate of 10 m³/h
- » Aluminum wounded Electric motor with the most affordable submersible pump on the market
- » Single stage

Kullanım kılavuzuna ulaşmak için QR kodu okutun.

Scan the QR code to access the user manual.



KOD CODE	AÇIKLAMA DESCRIPTION	GÜÇ POWER	DEBİ L/H FLOW L/H	BASMA YÜKSEKLİĞİ HEAD	KABLO CABLE	VOLTAJ VOLTAGE	FİYAT PRICE
19810123081	Dalgıç Pompa Submersible Pump	550W	10.000	8 mt	10 mt	220V/50Hz	90 €

FİLTRELER FILTERS



HAVUZ FİLTRELERİ POOL FILTERS

*Temiz bir havuzun sırrı, güçlü bir filtredir.
A crystal-clear pool begins with the right filter.*

Filtre, havuzun görünmeyen koruyucusudur.
The filter is your pool's invisible guardian.

Filtrasyon sistemi, suyun berraklığını ve hijyenini sağlar.
Neta Havuz, her havuz tipine uygun, güvenilir ve uzun ömürlü filtre çözümleri sunar.

*The filtration system ensures water clarity and hygiene.
Neta Pool provides reliable, long-lasting filter solutions for every pool type.*

Lamex® Filtreler

Lamex® Filters

GÜVENİLİR FİLTASYON TRUSTED FILTRATION

Türkiye'nin tercih edilen kum filtre markası Lamex, havuzlarda maksimum performans ve uzun ömür için tasarlanmıştır. Neta Havuz üretimi olan Lamex® filtreler, 2+2 yıl garantili, ömür boyu garantili çok yollu vanaları ve geniş model seçeneği ile her havuza güvenli ve etkili filtrasyon sunar.

Lamex®, Turkey's most preferred sand filter brand, is designed for maximum performance and durability in pools. Manufactured by Neta Pool, Lamex filters come with a 2+2 year warranty and lifetime-guaranteed multiport valves, delivering reliable and efficient filtration for every type of pool.



Model: LS 650



Lamex Filtreler Karşılaştırması

Lamex Filters Comparison



Model:	Çap Dia	Kullanım Alanı Area Of Use	Bağlantı Connection	Max. Debi Max. Flow
LS 500-900	500-900 mm	Konut Havuzu Residential Pool	1½"-2"	8-30 m³/h
LS 1050-2000	1050-2200 mm	Ticari Havuz/ Su Parkı Commercial Pools/ Waterparks	2½"-4"	35-190 m³/h

Lamex Serisi Filtreler

Lamex Series Filters

Özel ve Yarı Ticari Havuzlar İçin For Residential and Semi-Commercial Pools



GÜVENİLİR PERFORMANS VE SAĞLAM TASARIM

RELIABLE PERFORMANCE & DURABLE DESIGN

Lamex filtreler, farklı renklerde üretilebilme özelliği ile öne çıkar. İthal çok yollu vanası (Midas – Almanya / Praher – Avusturya), UV dayanımı ve ısıtmalı havuzlarla uyumluluğu sayesinde açık alanda uzun ömürlü kullanım sağlar.

Lamex filters stand out customizable body colors. Equipped with imported multiport valves (Midas – Germany / Praher – Austria), these UV-resistant filters are suitable for outdoor and heated pool use, offering long-lasting durability.



Model: LS 650



Model: LS 720



Teknik Bilgiler

- Tank Malzemesi: Polyester kaplamalı gövde
- Maks. Sıcaklık: 50°C
- Çalışma Basıncı: 2.5 bar
- Garanti: 2 +2 yıl
- Üretim: Türkiye'de üretilmiştir
- Kullanım Alanı: Tatlı ve tuzlu su havuzları için uygundur

Technical Details

- Tank Material: Polyester laminated body
- Max Temperature: 50°C
- Max Operating Pressure: 2.5 bar
- Warranty: 2 + 2 years
- Manufacturing: Made in Turkey
- Application: Suitable for fresh and saltwater pools

Neden Lamex?

Yüksek kaliteli hammaddesi, Avrupa menşeli vana seçenekleri ve UV dayanımı sayesinde Lamex, uzun ömürlü ve güvenilir filtrasyon sağlar. Türkiye'de üretilen bu filtreler, hem tatlı hem tuzlu su havuzları için mükemmel bir tercihtir.

Why Lamex?

With its high-quality raw materials, European valve options, and UV resistance, Lamex ensures long-lasting and reliable filtration. Manufactured in Turkey, these filters are an ideal choice for both fresh and saltwater pools.

ÖZEL AMAÇLI HAVUZ
RESIDENTAL POOL

UZUN ÖMÜRLÜ
LONG LASTING

POLYESTER KAPLAMALI
POLYESTER LAMINATED

TÜRKİYE'DE ÜRETİLMİŞTİR
MADE IN TURKEY

2+2 YIL GARANTİLİ
2+2 YEAR WARRANTY



Öne Çıkan Özellikler Product Features

- » Lamex model filtreler özel amaçlı havuz kullanımı içindir
- » İsteğe bağlı olarak farklı renklerde üretilebilir
- » İsteğe bağlı olarak şeffaf kapak ile verilebilir
- » Praher (Avusturya) çok yollu yandan vana
- » Isıtılmalı havuzlarda kullanıma uygundur
- » UV dayanımlıdır, açık ortamda montaj edilebilir
- » Her çeşit havuza, tatlı veya tuzlu suya uygundur

- » Suitable for residential pool
- » Optionally as it can be produced in different colors
- » Optionally as it can be produced in transparent lid upon request
- » Side mounted multiport valves Praher (Austria)
- » Can be used for heated pools
- » Can be installed outdoors
- » Suitable for all pools types, fresh or salt water

Teknik Bilgiler Technical Information

MODEL	A mm	B mm	C mm	D mm	E mm	-
LS 500 »	335	270	500	135	770	-
LS 650 »	380	320	650	140	800	-
LS 720 »	390	320	750	150	850	-
LS 800 »	400	325	800	1609	900	-
LS 900 »	460	370	950	240	1050	-

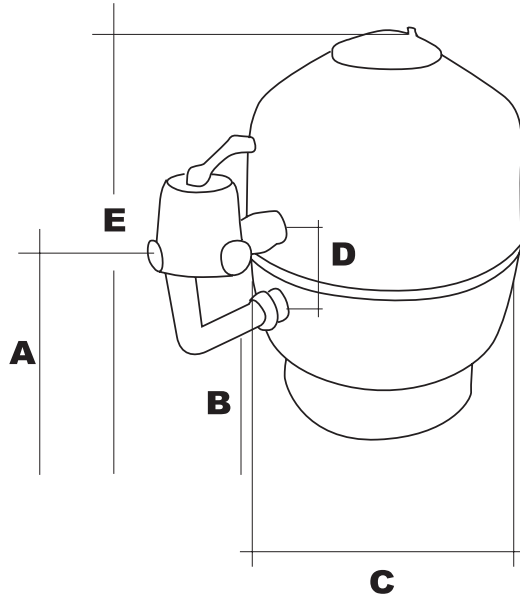

KOD CODE	ÇAP DIAMETER	BAĞLANTI GİRİŞ ÇIKIŞ INLET OUTLET	DEBİ m³/h FLOW	ÇALIŞMA BASINCI WORKING PRESSURE	MAX. ÇALIŞMA BASINCI MAX. WORKING PRESSURE	TEST BASINCI TEST PRESSURE	KUM SAND	AĞIRLIK WEIGHT	FİYAT PRICE
12015122046	500 mm	1 ½	8	1,5 bar	2,5 bar	3,5 bar	75 kg	18 kg	365 €
12015122021	650 mm	1 ½	15	1,5 bar	2,5 bar	3,5 bar	150 kg	19 kg	385 €
12015122077	720 mm	1 ½	22	1,5 bar	2,5 bar	3,5 bar	300 kg	27 kg	485 €
12015122078	720 mm	2"	22	1,5 bar	2,5 bar	3,5 bar	300 kg	27 kg	500 €
12015122022	800 mm	2"	22	1,5 bar	2,5 bar	3,5 bar	350 kg	30 kg	525 €
12015122037	900 mm	2"	30	1,5 bar	2,5 bar	3,5 bar	400 kg	37 kg	565 €

Ozona dayanıklı hammaddede ile üretim yapılması durumunda %30 fiyat farkı uygulanmaktadır.
In case of production with ozone-resistant raw material, additional 30% price increase is applied.

Lamex Serisi Filtreler Ticari Lamex Series Filters Commercial

Ticari Havuzlar, Su Parkları, Fıskiyeler İçin For Commercial Pools, Waterparks, Fountains etc.



HER HAVUZ TİPİ İÇİN ETKİN FİLTRASYON EFFECTIVE FILTRATION FOR ALL POOL TYPES

Lamex filtreler, farklı bağlantı ölçüleri ve tank çaplarıyla, hem küçük hem büyük hacimli havuzlar için ideal bir çözüm sunar. UV dayanımı ve uzun ömürlü yapısıyla dış ortamlarda güvenle kullanılır.

With various connection sizes and tank diameters, Lamex filters offer an ideal solution for both small and large volume pools. Their UV resistance and durable design make them reliable for outdoor use.



Model: LS 900



Teknik Bilgiler

- Tank Malzemesi: Polyester kaplamalı gövde
- Maks. Sıcaklık: 50°C
- Kapak: Ø50 cm çapında cam elyaf takviyeli plastik kapak
- Çalışma Basıncı: 2.5 bar
- Test Basıncı: 3.5 bar
- Garanti: 2 +2 yıl
- Üretim: Türkiye'de üretilmiştir
- Kullanım Alanı: Ticari havuzlar, su parkları ve fıskiye sistemleri için uygundur

Technical Details

- Tank Material: Polyester laminated body
- Max Temperature: 50°C
- Lid: Ø50 cm diameter plastic lid with fiber glass reinforcement
- Max Operating Pressure: 2.5 bar
- Test Pressure: 3.5 bar
- Warranty: 2 + 2 years
- Manufacturing: Made in Turkey
- Application: Suitable for commercial pools, waterparks, and fountains

Neden Lamex?

Yüksek debili ticari havuzlar için özel geliştirilen bu model, 50 cm genişliğinde cam elyaf takviyeli kapağıyla kolay bakım ve erişim sağlar. Fiberglas kompozit yapısı, zorlu koşullarda dahi maksimum dayanım sunar.

Why Lamex?

Specially designed for high-flow commercial pools, this model features a 50 cm fiberglass-reinforced plastic lid for easy maintenance and access. Its fiberglass composite body ensures maximum durability under tough conditions.

ÖZEL AMAÇLI HAVUZ
RESIDENTIAL POOL

UZUN ÖMÜRLÜ
LONG LASTING

POLYESTER KAPLAMALI
POLYESTER LAMINATED

TÜRKİYE'DE ÜRETİLMİŞTİR
MADE IN TURKEY

50 CM KAPAK
50 CM PLASTIC LID

2+2 YIL GARANTİLİ
2+2 YEAR WARRANTY



Öne Çıkan Özellikler Product Features

- » Lamex model filtreler ticari havuzlar, su parkları, fiskiyeler için uygundur
- » İsteğe bağlı olarak farklı renklerde üretilebilir
- » Ø50 cm cam elyaf takviyeli plastik kapak
- » Isıtılmalı havuzlarda kullanıma uygundur
- » Her çeşit havuza, tatlı veya tuzlu suya uygundur
- » UV dayanımlıdır
- » Açık ortamda montaj edilebilir
- » Aşındırıcı olmayan polyester, pürüzsüz çekici kaplamaya sahip fiberglas kompozit yapı
- » 6 yollu vana dahil değildir
- » Suitable for commercial pools, waterparks, fountains etc.
- » Optionally as it can be produced in different colors
- » Ø50 cm diameter plastic lid from fibre glass reinforced
- » Can be used for heated pools
- » Suitable for all pools types, fresh or salt water
- » UV resistant
- » Can be installed outdoors
- » Non-Corrosive polyester, fiberglass composite construction with smooth attractive finish
- » Excluded in 6-way valve

Teknik Bilgiler Technical Information

MODEL	A mm	B mm	C mm	D mm	E mm	-
LS 1050 »	670	440	1050	460	1380	-
LS 1250 »	570	360	1250	460	1350	-
LS 1450 »	800	630	1400	440	1630	-
LS 1600 »	850	690	1600	450	1750	-
LS 2000 »	900	785	2000	490	850	-

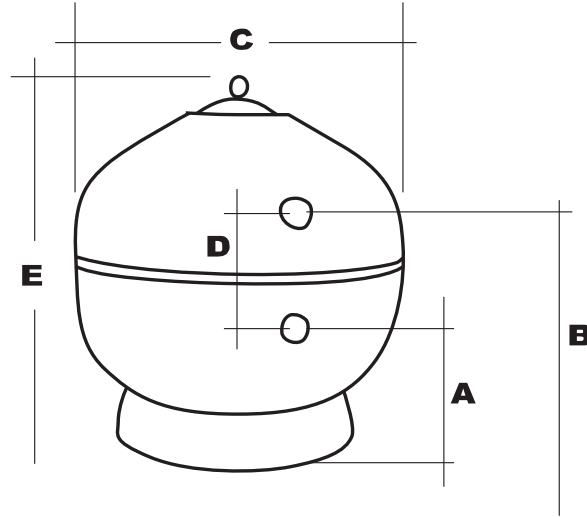

KOD CODE	ÇAP DIAMETER	BAĞLANTI GİRİŞ ÇIKIŞ INLET OUTLET	DEBİ m³/h FLOW	ÇALIŞMA BASINCI WORKING PRESSURE	MAX. ÇALIŞMA BASINCI MAX. WORKING PRESSURE	TEST BASINCI TEST PRESSURE	KUM SAND	AĞIRLIK WEIGHT	FİYAT PRICE
12015122056	1.050 mm	75	43	1,5 bar	2,5 bar	3,5 bar	1.050 kg	95 kg	847 €
12015122057	1.250 mm	90	56	1,5 bar	2,5 bar	3,5 bar	1.200 kg	110 kg	1.089 €
12015122063	1.400 mm	110	77	1,5 bar	2,5 bar	3,5 bar	1.950 kg	160 kg	1.573 €
12015122058	1.600 mm	110	100	1,5 bar	2,5 bar	3,5 bar	3.050 kg	175 kg	1.936 €
12015122059	2.000 mm	160	157	1,5 bar	2,5 bar	3,5 bar	4.950 kg	224 kg	3.135 €
12015122065	2.200 mm	200	190	1,5 bar	2,5 bar	3,5 bar	5.700 kg	425 kg	5.747 €

Ozona dayanıklı hammaddelerle üretim yapılması durumunda %30 fiyat farkı uygulanmaktadır.
In case of production with ozone-resistant raw material, additional 30% price increase is applied.

Rotex Serisi Plastik Filtreler Rotex Series Polyethylen Filter

Özel Havuzlar İçin For Residential Pools



DAYANIKLI GÖVDE, TEMEL İHTİYACA YETERLİ ÇÖZÜM DURABLE BODY, ESSENTIAL PERFORMANCE

Rotex, ticari havuz projelerinde temel filtrasyon ihtiyaçlarına ekonomik ve pratik bir çözüm sunar. UV dayanımı olmayan plastik gövdesi nedeniyle sadece kapalı alanlarda ve ısıtsız havuzlarda kullanımı uygundur.

Rotex offers an affordable and practical solution for basic filtration needs in commercial pools. Due to its non-UV-resistant plastic body, it is only suitable for indoor and unheated pool installations.



6 yollu vana ile birlikte
With 6-way valve



Model: Rotex 600



Teknik Bilgiler

- Gövde Malzemesi: Polietilen, rotasyon kalıplı
- Maks. Su Sıcaklık: 28°C
- Çalışma Basıncı: 1.5 bar
- Test Basıncı: 3.5 bar
- Üretim: Türkiye'de üretilmiştir

Technical Details

- Body Material: Rotomolded polyethylene
- Max Water Temperature: 28°C
- Working Pressure: 1.5 bar
- Test Pressure: 3.5 bar
- Manufacturing: Made in Turkey

Neden Rotex?

Yüksek fiyat-performans dengesi sunan Rotex filtreler, temel filtrasyon ihtiyacı olan projeler için idealdir. **Rotasyon kalıplama (rotomolding) yöntemiyle üretilmiş** hafif gövdesi, taşıma ve montajda kolaylık sağlar. Avusturya menşeli 6 yollu vanasıyla birlikte eksiksiz bir çözüm sunar.

Why Rotex?

Rotex filters offer an ideal balance of price and performance for essential filtration needs. **Its lightweight body is produced using the rotomolding method**, ensuring easy handling and installation. Delivered with a high-quality 6-way valve made in Austria, it provides a complete filtration solution.

ÖZEL AMAÇLI HAVUZ
RESIDENTIAL POOL

UZUN ÖMÜRLÜ
LONG LASTING

POLİETİLEN ROTASYON GÖVDE
ROTOMOLDING PE BODY

TÜRKİYE'DE ÜRETİLMİŞTİR
MADE IN TURKEY

2 GARANTİLİ
2 YEAR WARRANTY

MADE IN
EU



Öne Çıkan Özellikler Product Features

- » Avusturya menşeli altı yollu vana ile birlikte teslim edilir
- » Isıtılmalı havuzlar için uygun değildir MAX. 28C°
- » Plastik gövdeli olduğu için dış ortamda kullanımı tavsiye edilmez

- » Supplied with side multiport valve made by Austria
- » It is not suitable to use for heated pools. Max. operating temperature is 28 °C
- » It is not suitable for outdoor installation

Teknik Bilgiler Technical Information

MODEL	A mm	B mm	C mm	D mm
ROTEX 500 »	500	125	610	210
ROTEX 600 »	600	125	635	240
ROTEX 800 »	800	175	790	275
ROTEX 950 »	950	185	945	345

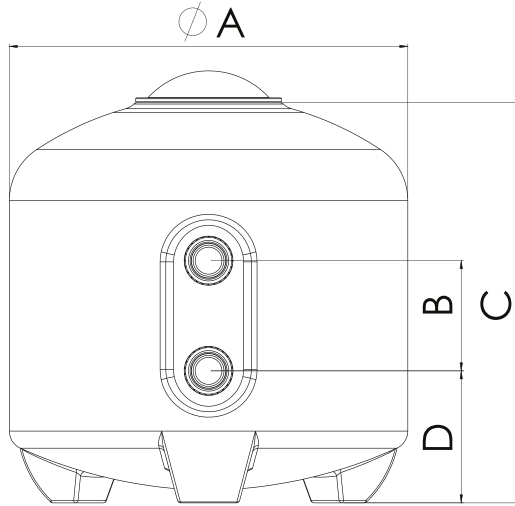

KOD CODE	ÇAP DIAMETER	BAĞLANTI GİRİŞ ÇIKIŞ INLET OUTLET	DEBİ m³/h FLOW	KUM kg SAND kg	ÇALIŞMA BASINCI WORKING PRESSURE	MAX. ÇALIŞMA BASINCI MAX. WORKING PRESSURE	TEST BASINCI TEST PRESSURE	FİYAT PRICE
12015122048	500 mm	50	10	75	1,5 bar	2,5 bar	3,5 bar	265 €
12015122053	600 mm	50	15	150	1,5 bar	2,5 bar	3,5 bar	290 €
12015122066	800 mm	63	22	275	1,5 bar	2,5 bar	3,5 bar	420 €
12015122067	950 mm	63	30	450	1,5 bar	2,5 bar	3,5 bar	510 €

Woundex Serisi WS Filtreler

Woundex Series WS Filters

Özel ve Yarı Ticari Havuzlar İçin For Residential and Semi-Commercial Pools



25 YILDIR DEĞİŞMEYEN KALİTE

25 YEARS OF UNCHANGING QUALITY

25 yıldır sahada kendini kanıtlayan Woundex filtreler, UV dayanımlı polyester bobin sargı gövdesi, gözlem camı ve ergonomik vana tasarımıyla her tip havuz için güvenilir bir çözüm sunar.

Proven in the field for 25 years, Woundex filters offer a reliable solution for all pool types with their UV-resistant polyester bobbin-wound body, sight glass, and ergonomic valve design.



Model: Ws 900

Teknik Bilgiler

- **Gövde Malzemesi:** UV dayanımlı polyester bobin sargı gövde
- **Maks. Sıcaklık:** 40°C
- **Çalışma Basıncı:** 2.5 bar
- **Test Basıncı:** 3.5 bar
- **Gözlem Camı:** Filtrasyon kalitesini izlemek için şeffaf cam
- **Difüzör:** Suyun eşit dağılmasını sağlar
- **Manometre:** İşletme basıncını kontrol etmek için
- **Tahliye Tapası:** Basınç altında kolay kum ve su boşaltımı
- **Vana:** 7 yollu vana ile birlikte
- **Garanti:** 2 + 2 yıl
- **Üretim:** Türkiye

Technical Details

- **Tank Material:** UV-resistant polyester bobbin-wound body
- **Max. Temperature:** 40°C
- **Working Pressure:** 2.5 bar
- **Test Pressure:** 3.5 bar
- **Sight Glass:** For monitoring filtered water
- **Top Diffuser:** Ensures even distribution of water
- **Pressure Gauge:** For operating pressure control
- **Drain Plug:** For sand and water discharge under pressure
- **Valve:** Included with 7-way valve
- **Warranty:** 2 + 2 years
- **Manufacturing:** Made in Turkey

Neden Woundex?

25 yıldan fazladır havuz sistemlerinin güvenilir tercihi olan Woundex filtreler, UV ışınlarına dayanıklı sağlam bobin sargı gövdesi ve yüksek filtrasyon performansı ile öne çıkar. Ergonomik tasarımı, manometreli kontrol sistemi ve detaylara gösterilen özen sayesinde hem kullanıcı dostu hem de uzun ömürlü bir çözüm sunar.

Why Woundex?

For over 25 years, Woundex filters have been the trusted choice in pool systems. With their durable UV-resistant bobbin-wound body and high filtration performance, they stand out in reliability. Designed with ergonomic details and equipped with a pressure gauge for control, Woundex offers a long-lasting and user-friendly solution.

TÜRKİYE'DE ÜRETİLMİŞTİR
MADE IN TURKEY

UZUN ÖMÜRLÜ
LONG LASTING

2+2 YIL GARANTİLİ
2+2 YEAR WARRANTY

MAX. 40°

TEST
2,5 BAR

MAX.
2,5 BAR

MAX.
50 m³/h/m²

Öne Çıkan Özellikler Product Features

- » Woundex WS model sağlam, UV ışınlarına dayanıklı polyester bobin sargı gövde
- » Ergonomik dizayn edilmiş altı yollu vana
- » Yüksek performanslı filtrasyon işlemi
- » Her çeşit havuza, tatlı veya tuzlu suya uygundur
- » İşletme basıncını kontrol etmek için manometre
- » Filtrelenmiş suyu gözlemek için gözetleme camı
- » Kilitli kelepçe, vananın 360° boyunca istenilen pozisyonda montaj yapılmasını sağlar
- » Suyun kum yatağının üzerine düzenli olarak dağılmasını sağlayan üst difüzör
- » Ani kış etkileri ve bakım için basınçla su ve kum tahliye çıkışı
- » 7 yollu vana ile birlikte

Teknik Bilgiler Technical Information

MODEL	A mm	B mm	C mm	D mm	E mm	F mm	G mm	Hacim Volume
525 »	780	525	220	650	370	400	320	0.22 m ³
625 »	880	625	220	800	420	450	350	0.30 m ³
750 »	960	750	220	900	550	600	400	0.45 m ³
900 »	1100	900	220	1100	640	700	500	0.64 m ³

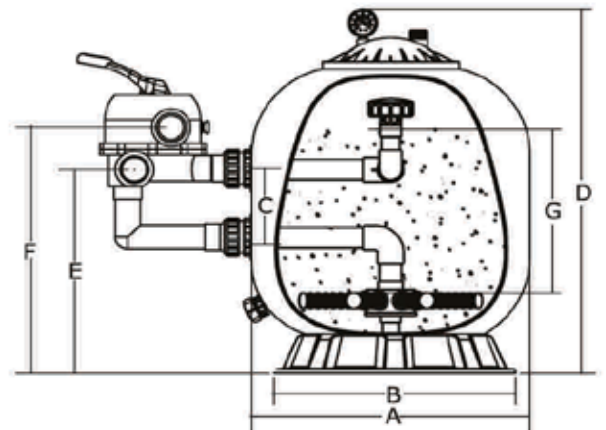

KOD CODE	ÇAP DIAMETER	BAĞLANTI GİRİŞ ÇIKIŞ INLET OUTLET	DEBİ m ³ /h FLOW	KUM kg SAND kg	AĞIRLIK Kg WEIGHT Kg	FİYAT PRICE
12015123100	525 mm	50 mm	12	85	14.4	285 €
12015123101	625 mm	50 mm	16	150	18	350 €
12015123102	750 mm	63 mm	23	300	34	510 €
12015123103	900 mm	63 mm	31	470	59	630 €

WOUNDEx
SERIES
25 YILDIR
AYNI ÜRÜN – AYNI KUSURSUZLUK – AYNI KALİTE
FOR OVER 25 YEARS
SAME PRODUCT – SAME FLAWLESSNESS – SAME QUALITY

- » Heavy duty UV protected polyester bobbin wound tank
- » Ergonomically designed six position multiport valve
- » High performance filtering action
- » Suitable for all pools types, fresh or salt water
- » Special glycerine stainless construction pressure gauge for operating pressure
- » Sight glass for inspection of the filtered water
- » Clamp lock is designed to allow 360 degree rotation to simplify installation
- » Top diffuser ensures even distribution of water over the sand bed
- » A plug to drain out for sand and water drain with pressure
- » Included in 7-way valve

6 Yollu Vanalar

6-Way Valves

ÇOK YÖNLÜ AKIŞ KONTROL ÇÖZÜMÜ

VERSATILE FLOW CONTROL SOLUTION

Öne Çıkan Özellikler

Product Features

- » ABS gövdeden üretilmiştir
- » Dişli ve yapıştırmalı bağlantı seçenekleri
- » 6 farklı fonksiyonu tek kolla yönetme imkanı
- » Yandan veya üstten montaj seçenekleri
- » Made of ABS body
- » Slip and threaded connection options
- » 6-function operation with a single handle
- » Side or top mount options



Praher 6 Yollu Vanalar Praher 6-Way Valves

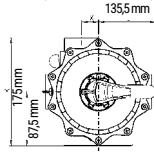
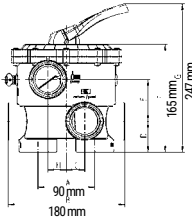

Giriş Yapıştırma / Slip Inlet
Yandan / Side

Çıkış Yapıştırma / Slip Outlet
Alttan / Lower

KOD CODE	BAĞLANTI CONNECTION	FİYAT PRICE
168223021	1,5' ø mm	115 €

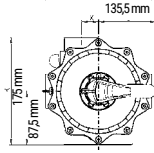
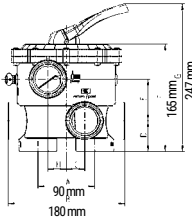

Giriş Dişli / Threaded Inlet
Yandan / Side

Çıkış Dişli / Threaded Outlet
Alttan / Lower

KOD CODE	BAĞLANTI CONNECTION	FİYAT PRICE
16518223006	1,5' ø mm	120 €

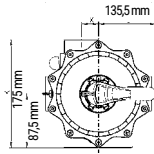
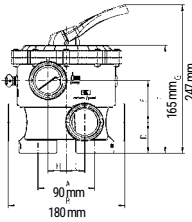

Giriş Yapıştırma / Slip Inlet
Yandan / Side

Çıkış Yapıştırma / Slip Outlet
Alttan / Lower

KOD CODE	BAĞLANTI CONNECTION	FİYAT PRICE
168223022	2' ø mm	135 €

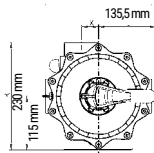
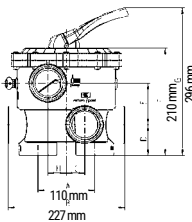

Giriş Yapıştırma / Slip Inlet
Yandan / Side

Çıkış Yapıştırma / Slip Outlet
Alttan / Lower

KOD CODE	BAĞLANTI CONNECTION	FİYAT PRICE
16518213002	2,5' ø mm	490 €

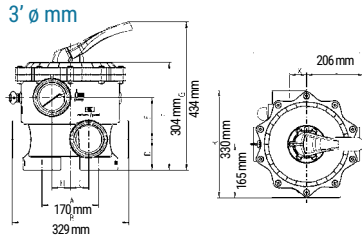

Giriş Yapıştırma / Slip Inlet
Yandan / Side

Çıkış Yapıştırma / Slip Outlet
Alttan / Lower

KOD CODE	BAĞLANTI CONNECTION	FİYAT PRICE
16518223008	3' ø mm	850 €

Midas 6 Yollu Vanalar Midas 6-Way Valves



Giriş Yapıştırma / Slip Inlet
Yandan / Side

Çıkış Yapıştırma / Slip Outlet
Alttan / Lower

KOD CODE	BAĞLANTI CONNECTION	FİYAT PRICE
168223010	1,5' ø mm	95 €

Dişli körtapalı
Threaded with end cap



Giriş Yapıştırma / Slip Inlet
Yandan / Side

Çıkış Yapıştırma / Slip Outlet
Alttan / Lower

KOD CODE	BAĞLANTI CONNECTION	FİYAT PRICE
168223006	2,5' ø mm	--

Ara bağlantı parçaları
Union fitting included

Waterfun 6 Yollu Vanalar Waterfun 6-Way Valves



Giriş Yapıştırma / Slip Inlet
Üstten / Top

Çıkış Yapıştırma / Slip Outlet
Alttan / Lower

KOD CODE	BAĞLANTI CONNECTION	FİYAT PRICE
168123005	2' ø mm	102 €

Dişli
Threaded

Waterco 6 Yollu Vanalar Waterco 6-Way Valves

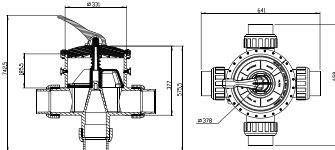

Giriş Yapıştırma / Slip Inlet
Yandan / Side

Çıkış Yapıştırma / Slip Outlet
Alttan / Lower

KOD CODE	BAĞLANTI CONNECTION	FİYAT PRICE
16518293007	4' ø mm	1.450 €

Dişli
Threaded

3 Yollu Vanalar

3-Way Valves

AKIŞI YÖNETİN, BASİT VE ETKİLİ

SIMPLE & EFFECTIVE FLOW CONTROL

PVC gövdeli 3 yollu vanalar, sistem içerisindeki sıvı akış yönünü değiştirmek için kullanılır. Yüksek basınca dayanıklıdır ve yapıştırırmalı bağlantı ile kolay montaj sağlar.

PVC-bodied 3-way valves are used to control or change the direction of fluid flow in the system. Designed for high pressure and easy installation with slip connections.

Öne Çıkan Özellikler

Product Features

- » Sistemdeki akış yönünü değiştirmek için kullanılır
- » PVC'den üretilmiştir
- » Yapıştırma bağlantı: İçten 50 mm, dıştan 63 mm
- » Test basıncı 15 bar, çalışma basıncı 10 bardır
- » It is used to change the flow direction in the system
- » Made of PVC
- » Slip Connection: 50 mm inside, 63 mm outside
- » Testing pressure in 15 bar, working pressure in 10 bar

Midas 3 Yollu Vanalar Midas 3-Way Valves



KOD CODE	BAĞLANTI CONNECTION	FİYAT PRICE
16518223003	50-63 ø mm	23 €

KULLANIM ALANLARI

- HAVUZ TESİSAT HATLARI
- YÖNLENDİRME SİSTEMLERİ
- SU GERİ DÖNÜŞ HATTI KONTROLÜ
- BY-PASS UYGULAMALARI



**Kolay
Montaj**
Easy
Installation



**Yüksek
Dayanım**
High
Durability

APPLICATIONS

- POOL PLUMBING LINES
- DIVERTING SYSTEMS
- WATER RETURN LINE CONTROL
- BY-PASS APPLICATIONS



Rejeneratif Filtreler

Regenerative Media Filters

Özel, Ticari Yarı Ticari Havuzlar İçin For Residential, Semi-Commercial and Commercial Pools

MINİMUM ALANDA MAKSİMUM FİLTRASYON

MAXIMUM FILTRATION IN MINIMUM SPACE

Regfilter rejeneratif filtreler, daha az alanda daha fazla suyu filtreleme yeteneğiyle, havuzlar ve endüstriyel uygulamalar için sürdürülebilir bir çözüm sunar.

Regfilter regenerative filters offer a sustainable solution for pools and industrial applications, thanks to their ability to filter more water using less space.



Teknik Bilgiler

- Fiberglass takviyeli polyester gövde
- Patentli "kendini temizleme" sistemi
- Kum, cam veya diatomlu filtrelere göre daha uzun ömürlü filtrasyon
- Su, enerji ve kimyasal kullanımında yüksek tasarruf
- Mobil parçalar veya titreşim olmadan sessiz çalışma
- Yüksek debi kapasitesi (örn. 125-225 m³/h)
- Kompakt tasarımıyla alandan %75 tasarruf sağlar
- Farklı çap ve model seçenekleri ile geniş uygulama alanı
- Perlit filtreleme malzemesiyle verimli performans
- Endüstriyel kullanım, su parkları, havuzlar ve göletler için uygundur

Technical Details

- Fiberglass reinforced polyester body
- Patented self-cleaning system
- Longer-lasting filtration compared to sand, glass, or diatomaceous filters
- Significant savings in water, energy, and chemical use
- Silent operation without mobile parts or vibrations
- High flow rate capacity (e.g. 125-225 m³/h)
- Compact design saves up to 75% space
- Various diameter and model options for a wide range of applications
- Efficient performance with perlite media
- Ideal for industrial use, water parks, pools, and artificial lakes

Tasarrufta Lider

Rejeneratif filtreler, küçük gövdeleriyle büyük su hacimlerini filtreleyebilme özelliği sayesinde son yıllarda daha çok tercih ediliyor. Geleneksel filtrelere kıyasla daha verimli çalışır, yüksek filtrasyon kalitesi sunar ve su ile enerji maliyetlerini ciddi oranda düşürür.

Leader In Saving

Regenerative filters have become increasingly popular for their ability to filter large water volumes with compact bodies. Compared to traditional filters, they offer higher efficiency, excellent filtration quality, and significant savings in water and energy costs.



SU TASARRUFU
WATER SAVING



ALAN TASARRUFU
SPACE SAVING



ENERJİ TASARRUFU
ENERGY SAVING

Öne Çıkan Özellikler Product Features

» Patentli bir teknolojiye dayanan REGFILTER, kum veya cam filtreler gibi daha geleneksel teknolojilere kıyasla filtreleri için daha iyi bir performans ile daha uzun bir ömür beklentisi ve maksimum su, enerji ve kimyasal tasarrufu elde etti. Rejeneratif ortam filtreleri REGFILTER, aynı zamanda bakım maliyetlerinden tasarruf sağlayan ve mobil parçalar ve titreşimler olmaksızın, karmaşık temizleme işlemlerine gerek olmadan, patentli bir "kendi kendini temizleme" sistemine sahiptir.

» Regfilter, based on a patented technology, has achieved a better performance and a longer life expectancy for its filters and a maximum water, energy and chemical savings, compared to more conventional technologies, such as sand or glass filters. The regenerative media filters Regfilter includes a patented self-cleaning system that also allows maintenance cost savings and make complicated cleaning operations not necessary, without mobile parts or vibrations.

Debi oranı 2.5 ve 4.5 m³/h/m² filtre oranında Flow rates at 2.5 and 4.5 m³/h/m² filter rates

ÇAP DIAMETER	MODEL MODEL	BAĞLANTI GİRİŞ ÇIKIŞ INLET OUTLET	DEBİ m ³ /h FLOW	PERLİT kg SAND kg	YÜKSEKLİK HEIGHT	FİLTRE ALANI FILTER AREA
400 mm	RF-3xxL-400	DN 65	15-27	3	1.800 mm	6,0 m ²
600 mm	RF-3xxL-600	DN 125	40-71	8	1.900 mm	15,8 m ²
800 mm	RF-3xxL-800	DN 150	77-139	16	1.950 mm	30,9 m ²
1.000 mm	RF-3xxL-1000	DN 200	130-234	25	2.050 mm	52,0 m ²
1.200 mm	RF-3xxL-1200	DN 250	170-307	36	2.100 mm	68,2 m ²
1.400 mm	RF-3xxL-1400	DN 250	232-418	45	2.100 mm	93,0 m ²
1.600 mm	RF-3xxL-1600	DN 300	300-540	60	2.200 mm	120,0 m ²
620 mm	RF-PRFV-620	D125 - DN110	36-64	7	1.850 mm	14,2 m ²
750 mm	RF-PRFV-750	D140 - DN125	54-98	11	1.900 mm	21,8 m ²
900 mm	RF-PRFV-900	D160 - DN150	79-142	16	1.950 mm	31,6 m ²
1.050 mm	RF-PRFV-1050	DN200	125-225	24	2.050 mm	50,1 m ²
1.200 mm	RF-PRFV-1200	DN250	162-292	34	2.100 mm	64,8 m ²
1.400 mm	RF-PRFV-1400	D315 - DN300	227-408	44	2.200 mm	90,7 m ²
1.600 mm	RF-PRFV-1600	D315 - DN300	286-514	58	2.200 mm	114,3 m ²

Flowclear Kum Filtresi Flowclear Sand Filter

Özel Havuzlar İçin For Residential Pools

TÜRKİYE'DE BİR İLK THE FIRST IN TURKEY

Türkiye'de dış mekanda kullanılabilen ilk kompakt filtrasyon sistemi!

UV dayanımlı gövdesi, entegre zamanlayıcısı ve bakım kolaylığı ile Floxclear, 60 tona kadar havuzlar için ideal bir kum filtre çözümdür.

The first compact outdoor filtration system available in Turkey!

With a UV-resistant tank, built-in timer, and easy maintenance, Floxclear offers a reliable sand filter solution for pools up to 60 tons.



CE

Teknik Bilgiler

- Tank Malzemesi: UV dayanımlı dayanıklı plastik
- Pompa Gücü: 0,27 hp (200W)
- Giriş/Çıkış: 32 mm hortum bağlantısı
- Entegre Zamanlayıcı: Var
- Filtrasyon ortamı: Kuvars havuz filtresi kumu veya filtre topu uyumlu
- Uygunluk: 1.100 - 18.100 L (300 - 4.800 galon) havuzlar için önerilir

Technical Details

- Tank Material: Durable, UV-resistant plastic
- Pump Power: 0.27 hp (200W)
- Inlet/Outlet Size: 32 mm hose connection
- Integrated Timer: Yes
- Filtration Media: Compatible with pool filter sand or filter balls
- Pool Compatibility: Recommended for pools between 1,100 - 18,100 L (300 - 4,800 gallons)

Neden Flowclear Kum Filtresi?

Dünyaca ünlü Bestway markasının kompakt tasarımı Floxclear kum filtresi, 60 tona kadar olan havuzlarda yüksek verimle çalışır. Elektrik panosu ya da makine dairesi gerektirmeyen yapısı sayesinde kurulum kolaylığı sunar. Dış ortam şartlarına dayanıklı gövdesi, ön filtreli pompası ve düşük enerji tüketimiyle kullanıcı dostu ve ekonomik bir çözüm sunar.

Why Flowclear Sand Filter?

A globally recognized brand, Bestway's Floxclear sand filter delivers efficient performance for pools up to 60 tons. Its design requires no electrical panel or machine room, making installation effortless. With a weather-resistant body, pre-filtered pump, and low energy consumption, Floxclear stands out as a user-friendly and cost-effective solution.

DÜNYA MARKASI
GLOBAL BRAND

UZUN ÖMÜRLÜ
LONG LASTING

KOLAY KURULUM
EASY INSTALLATION



ürün montaj
assembly



nasıl çalışır
working

Öne Çıkan Özellikler Product Features

- » 60 tona kadar olan yüzme havuzları için uygun
- » Kompakt, dış mekan koşullarına uygun yapı (yağmur, kar etkilemez)
- » Dahili zaman ayarı (timer) ve ON/OFF anahtarı
- » Makina dairesi veya elektrik panosu gerektirmez
- » Kolay kurulum, minimum bakım
- » Pompa ön filtresi sayesinde kir tutucu koruma
- » Monofaze motor
- » Kum yatağına eşit su dağılımı sağlayan difüzör
- » Düşük enerji tüketimi
- » Uygun maliyetli çözüm
- » Suitable for swimming pools up to 60 tons
- » Compact and weatherproof design (resistant to rain and snow)
- » Built-in timer and ON/OFF switch
- » No need for a machine room or electrical panel
- » Easy installation, minimal maintenance
- » Pre-filter protects pump by trapping debris
- » Single-phase motor
- » Diffuser ensures even water distribution over the sand bed
- » Low energy consumption
- » Cost-effective solution

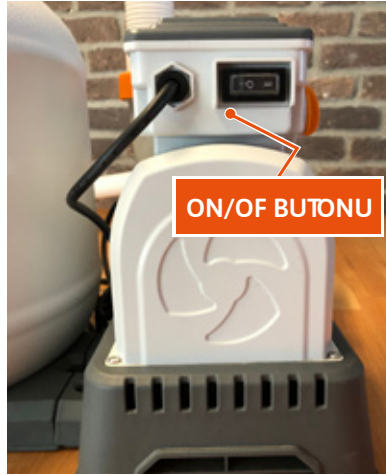

ON/OFF BUTONU



Kullanım Alanları Application Areas

- » Yüzme havuzları (60 tona kadar)
- » Çocuk havuzları
- » Süs havuzları
- » Sulama ve peyzaj sistemleri
- » Jakuzi ve doğal havuzlar
- » Balık havuzları
- » Su arıtma ön filtrasyonu
- » Kaskad şelaleler
- » Swimming pools up to 60 tons
- » Children's pools
- » Decorative/fountain pools
- » Irrigation pools
- » Jacuzzis
- » Fish ponds
- » Pre-filtration systems for water treatment
- » Cascade waterfalls

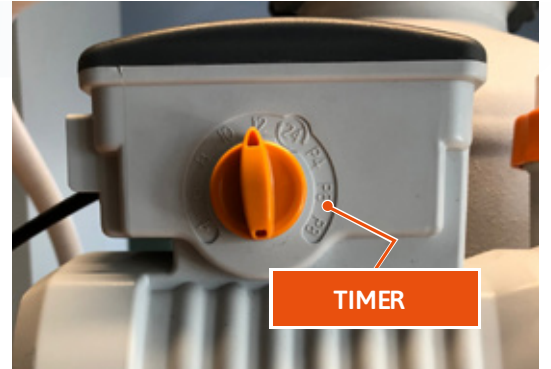

TIMER

KOD CODE	MODEL MODEL	DEBİ m ³ /h FLOW	KUM kg SAND kg	FİYAT PRICE
PSFAC58486	11355 L / 3000 GAL	11,50 m ³ /saat	36	534 €

Filtrasyon Blokları

Filtration Blocks

Özel Havuzlar İçin For Residential Pools



PRATİK FİLTRASYON ÇÖZÜMÜ

PRACTICAL FILTRATION SOLUTION

Kartuş veya kum filtreli seçenekleriyle, makina dairesi olmayan havuzlara uygun kompakt filtrasyon blokları; kurulum kolaylığı, düşük enerji tüketimi ve yüksek performans sunar. Tüm parçaları bir araya getiren entegre tasarımıyla montaj sürecini basitleştirir, yerden tasarruf sağlar.

Available with cartridge or sand filter options, these compact filtration blocks are designed for pools without a machine room. They offer easy installation, low energy consumption, and high performance. The integrated design simplifies setup and saves space.

	Model	a	b	c	d	e	f		Model	a	b	c	d	e	f		Model	a	b	c	d	e	f
	1001-C	85 cm	30 cm	30 cm	70 cm	60 cm	50 cm		1002-C	85 cm	30 cm	30 cm	70 cm	60 cm	50 cm		1003-C	78 cm	41 cm	10 cm	85 cm	34 cm	--
	Model	a	b	c	d	e	f		Model	a	b	c	d	e	f		Model	a	b	c	d	e	f
	1004-C	78 cm	41 cm	45 cm	85 cm	34 cm	--		1005-C	78 cm	40 cm	45 cm	55 cm	--	--		1006-C	78 cm	40 cm	10 cm	55 cm	--	--
	Model	a	b	c	d	e	f		Model	a	b	c	d	e	f		Model	a	b	c	d	e	f
	1001-S	85 cm	30 cm	30 cm	70 cm	--	--		1002-S	85 cm	30 cm	30 cm	70 cm	--	--		1003-S	78 cm	41 cm	10 cm	85 cm	34 cm	--

FİLTRASYON BLOKLARINA İLAVE OPSİYONEL SEÇENEKLER

OPTIONAL OPTIONS IN ADDITION TO FILTRATION BLOCKS

YEDEK KARTUŞ FİLTRE

SPARE PART CARTRIDGE FILTER

POLYESTER MAKİNA DAİRESİ POLYESTER MACHINE ROOM	70x60 h:50 100x100 h:90 140x140 h:105	KOD CODE 02099002907
HAVUZ TEMİZLİK SETİ POOL CLEANING KIT	1 Takım (süpürge, sapı ve hortumu, kepçe, fırça, cl-pH test kiti) 1 Set (broom, handle and hose, bucket, brush, cl-pH test kit)	ÖLÇÜ SIZE H:350 D:140 D:60 cm
DEZENFEKSİYON CİHAZLARI DISINFECTION EQUIPMENTS	- Blue Lagoon UV-C ultraviyole ile dezenfeksiyon cihazı 40w - Tuz klor jeneratörü SSC mini tuzdan klor üretir - Blue Lagoon with UV-C ultraviolet disinfection device 40w - Salt chlorine generator SSC mini produces chlorine from salt	FİYAT PRICE 60 €
HAVUZ SUYU ISITMA CİHAZI POOL HEATER	Elektrikli Nano SPA Electro marka 6 kW eşanjör Electric Nano SPA Electro brand 6 kW heat exchanger	

OPSİYONEL OPTIONAL

MODEL / KOD MODEL / CODE	FİLTRE TÜRÜ FILTER	SKIMFİLTRE SKIMFILTER	POMPA PUMP	MAX. HAVUZ m ² MAX. POOL m ²	MAKİNA DAİRESİ MECHANICAL ROOM	İÇİNDEKİLER CONTENTS	FİYAT PRICE
FB 1001-C CARMAX1ING75M 	Kartuş Cartridge	1 Adet 1 Pcs	0,75 Hp Monofaze	45	✓ Var	2x1.80 m ² kartuş filtre, 15.3 m ³ /h pompa (220V), 1 nozul, 1 lamba, 1 kumanda panosu 2x1.80 m ² cartridge filter, 15.3 m ³ /h pump (220V), 1 nozzle, 1 lamp, 1 control panel	2.208 €
FB 1002-C CAMAX2ING150M 	Kartuş Cartridge	1 Adet 1 Pcs	1,50 Hp Monofaze	90	✓ Var	4x1.80 m ² kartuş filtre, 20.4 m ³ /h pompa (220V), 1 nozul, 1 lamba, 1 kumanda panosu 4x1.80 m ² cartridge filter, 20.4 m ³ /h pump (220V), 1 nozzle, 1 lamp, 1 control panel	2.323 €
FB 1003-C CARMED2ING75M 	Kartuş Cartridge	1 Adet 1 Pcs	0,75 Hp Monofaze	45	Opsiyonel Optional	2x1.80 m ² kartuş filtre, 15.3 m ³ /h pompa (220V), 1 nozul, 1 lamba, 1 kumanda panosu 2x1.80 m ² cartridge filter, 15.3 m ³ /h pump (220V), 1 nozzle, 1 lamp, 1 control panel	1.829 €
FB 1004-C CARMED1TOP75M 	Kartuş Cartridge	1 Adet 1 Pcs	0,75 Hp Monofaze	45	✓ Var	2x1.80 m ² kartuş filtre, 15.3 m ³ /h pompa (220V), 1 nozul, 1 lamba, 1 kumanda panosu 2x1.80 m ² cartridge filter, 15.3 m ³ /h pump (220V), 1 nozzle, 1 lamp, 1 control panel	1.945 €
FB 1005-C CARMIN1ING50M 	Kartuş Cartridge	1 Adet 1 Pcs	0,50 Hp Monofaze	20	Opsiyonel Optional	1x1.80 m ² kartuş filtre, 11.7 m ³ /h pompa (220V), 1 nozul, 1 kumanda panosu 1x1.80 m ² cartridge filter, 11.7 m ³ /h pump (220V), 1 nozzle, 1 control panel	1.846 €
FB 1006-C CARMIN1TOP50M 	Kartuş Cartridge	1 Adet 1 Pcs	0,50 Hp Monofaze	20	Opsiyonel Optional	1x1.80 m ² kartuş filtre, 11.7 m ³ /h pompa (220V), 1 nozul, 1 pano 1x1.80 m ² cartridge filter, 11.7 m ³ /h pump (220V), 1 nozzle, 1 panel	1.789 €
FB 1001-S SANMAX1ING75M 	Kum Sand	1 Adet 1 Pcs	0,75 Hp Monofaze	45	Opsiyonel Optional	15.3 m ³ /h pompa (220V), 1 nozul, 1 lamba, 1 kumanda panosu 15.3 m ³ /h pump (220V), 1 nozzle, 1 lamp, 1 control panel	2.175 €
FB 1002-S SAMAX21N6150M 	Kum Sand	1 Adet 1 Pcs	1,50 Hp Monofaze	90	Opsiyonel Optional	15.3 m ³ /h pompa (220V), 1 nozul, 1 lamba, 1 kumanda panosu 15.3 m ³ /h pump (220V), 1 nozzle, 1 lamp, 1 control panel	2.670 €
FB 1003-S SANMED1ING75M 	Kum Sand	Kum Sand	0,75 Hp Monofaze	45	Opsiyonel Optional	15.3 m ³ /h pompa (220V), 1 nozul, 1 lamba, 1 kumanda panosu 15.3 m ³ /h pump (220V), 1 nozzle, 1 lamp, 1 control panel	1.795 €

Neden Filtrasyon Bloğu?

Makine dairesi olmayan kompakt havuzlar için ideal çözüm. Filtrasyon bloğu, kolay kurulum ve minimum bakım avantajı sunar.

Why Filtration Blocks?

Ideal solution for compact pools without a machine room. Filtration block offers easy installation and minimal maintenance.



ürünleri inceleyin
for detail

Kartuş Filtre Cartridge Filter

25 MİKRON FİLTRELEME 25 MICRON FİLTRATION



UV dayanımlı yapısı, ABS gövdesi ve 25 mikron hassasiyetiyle, ısıtılmış havuzlar da dahil olmak üzere yoğun kullanıma uygun ideal kartuş filtre.

UV-resistant body, ABS housing, and 25-micron precision make this cartridge filter ideal even for heated pools and heavy use.

 ISITMALI HAVUZLARDA KULLANIMA UYGUN
CAN BE USED FOR HEATED POOLS

 HASSAS FİLTASYON 25 MİKRON
PRECISION FILTRATION 25 MICRON

 KOLAY KURULUM
EASY INSTALLATION

 MAX. 40°
 MAX. 2,5 BAR



Öne Çıkan Özellikler Product Features

- » 2 adet bağlantı rakorları üzerinde sevk edilir
- » Yoğun kullanıma uygun halka kilit kapak
- » Vidalı hava tahliye tapası
- » UV dayanımlı, açık ortamda montaj edilebilir
- » ABS plastik gövde
- » Kolay montaj
- » 2 Pcs unions includes in the box
- » Suitable for intensive use, ring lock cover
- » Manual screw bleeder valve for purging air inside the filter
- » UV resistance body, can be installed outside
- » ABS plastic housing
- » Easy installation

Ölçüler Dimensions

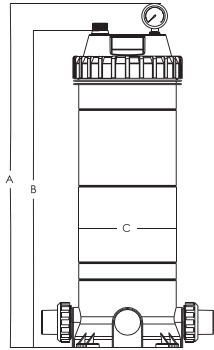

MODEL	A mm	B mm	C mm
KF 25	445	387	225
KF 50	625	567	225
KF 75	805	747	225
KF 100	985	927	225
KF 150	1.165	1.107	225
KF 200	1.345	1.287	225

Yedek Kartuş Replacement Cartridge Filter

MODEL	KOD	D mm	E mm	MICRON	FİYAT PRICE
KF 25	19811123004	183	184,5	≤15	45 €
KF 50	19811123005	183	364,5	≤15	75 €
KF 75	19811123006	183	544,5	≤15	89 €
KF 100	19811123007	183	724,5	≤15	93 €
KF 150	19811123008	183	904,5	≤15	104 €
KF 200	19811123009	183	1.091	≤15	146 €



KOD CODE	MODEL MODEL	BAĞLANTI GİRİŞ ÇIKIŞ INLET OUTLET	DEBİ m³/h FLOW	FİYAT PRICE
12016123001	KF 25	50 mm	5,50	195 €
12016123002	KF 50	50 mm	11,40	245 €
12016123003	KF 75	50 mm	17,00	290 €
12016123004	KF 100	50 mm	22,90	340 €
12016123005	KF 150	50 mm	33,40	385 €
12016123006	KF 200	50 mm	40,90	475 €

Cam Medya Glass Media



KOD CODE	AMBALAJ PACKING	ÇAP DIAMETER	FİYAT PRICE
12018302001	25 kg	0,5-1,2 mm	20 €
12018302003	25 kg	1,2-3,2 mm	20 €
12018302002	25 kg	3,2-5,0 mm	20 €



Üretim Yeri / Manufacturing Location
Türkiye'de Üretilmiştir / Made in Turkey

Kullanım Ömrü / Product Life
Daha Uzun Ömürlü / Long Lasting

Çevreye Etki / Environmental Impact
Çevreyi Korur / Protects the Environment

Marka / Brand
Neta Havuz Ürünü / Neta Pool Product

Öne Çıkan Özellikler Product Features

- » Şeffaf pencere camından üretilmiştir, geri dönüşüm şişe içermez » Made of transparent pure window glass, do not contain recycling bottles
- » Üç ayrı çapta üretilmektedir » Three different granulometry are available
- » Kuvars kuma göre daha uzun ömürlüdür » A longer life span than quartz sand
- » Kireçli sularda taşlaşma yapmaz » In limy water it does not petrified
- » Ters yıkamada tam temizleme özelliği » Full cleaning feature in backwash
- » Kuvars kuma göre %20 daha iyi filtrasyon kapasitesi » %20 more filtration capacity than quartz sand
- » Ters yıkamadan ötürü oluşan su kaybını azaltır » Saving on backwashing water
- » Enerji ve kimyasal tasarrufu sağlar » Energy saving and less use of pool chemical
- » 1 big bag içinde 40x25 kg torba vardır » There are 40x25 kg bags in 1 big bag

Kuvars Kum Quartz Sand



KOD CODE	AMBALAJ PACKING	ÇAP DIAMETER	FİYAT PRICE
12018132001	25 kg	0,5-1,2 mm	10 €
12018132002	25 kg	1-3 mm	10 €
12018132003	25 kg	3-5 mm	10 €

Havuz Tipi / Pool Type
Özel ve Ticari / Residential & Commercial

Üretim Yeri / Manufacturing Location
Türkiye'de Üretilmiştir / Made in Turkey

Kullanım Ömrü / Product Life
Daha Uzun Ömürlü / Long Lasting

Çevreye Etki / Environmental Impact
Çevreyi Korur / Protects the Environment

Marka / Brand
Neta Havuz Ürünü / Neta Pool Product

Öne Çıkan Özellikler Product Features

- » Doğal malzemeden üretilmiştir » Produced from natural material
- » Ürün yıkanmış ve fırınlanmıştır » Quartz sand washed and kiln-dried
- » Yüksek kaliteli ambalaj » High quality package

Zeolit

Zeolite

ZEOLİT GÜCÜYLE TASARRUF EFFICIENCY WITH ZEOLITE

Mineral yapısı sayesinde berrak ve sağlıklı su sağlar.
Klor kokusunu azaltır, suyu kristal berraklıkta tutar.

*Delivers clear and healthy water with its mineral texture.
Reduces chlorine odor and keeps your water crystal clear.*

TÜRKİYE'DE ÜRETİLMİŞTİR
MADE IN TURKEY

ENERJİ TASARRUFU
ENERGY SAVING

DOĞAL MİNERAL
NATURE MINERAL

CE



Öne Çıkan Özellikler Product Features

- » Zeolit, kuvars kum ile karşılaştırıldığında çok berrak bir su üretir
- » Yüksek yüzey alanına ve kil ve koloidal partikülleri etkin şekilde filtre edebilen geniş iç boşluk alanına sahip tamamen doğal bir üründür. Temiz ortamdaki basınç düşüşü, tipik silis kumundan daha azdır.
- » Havuzunuz hep parlak kalır
- » Su, enerji, işgücü ve kimyasallarda tasarruf sağlar
- » Tüm kum filtrelerinde (hızlı ve yavaş tipler) kuvars yerine kullanılabilir
- » İşletme maliyetlerini düşürür
- » Ters yıkamayı % 50 azaltır
- » Kloraminleri, kokuyu ve göz yanmasını azaltır
- » Islak Partikül Yoğunluğu: 1,800 gram/litre
- » Tamamen doğaldır
- » Produces very clear water compared to quartz sand
- » An all-natural zeolite with a high surface area and large internal cavity area that can effectively filter clay and colloidal particles. The pressure drop in clean media is less than typical silica sand
- » Your pool always stays bright
- » It saves water, energy, labor and chemicals
- » Can be used instead of quartz in all sand filters (fast and slow types)
- » It reduces operating costs
- » Reduces backwashing by 50%
- » Reduces chloramines, odor and eye burning
- » Wet Particle Density: 1,800 grams/liter
- » It is completely natural

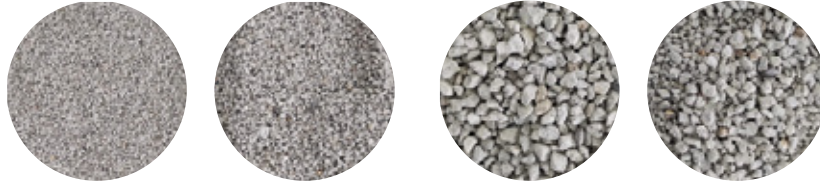

KOD CODE	BOYUT mm SIZE mm	FİYAT PRICE
2099003296	0,6 - 1	-
2099003297	1 - 2	-
2099003298	2 - 4	-
2099003299	4 - 7	-

Makina Dairesi Machine Room

Polyester Makina Dairesi Polyester Filtration Room



KOD CODE	İÇ ÖLÇÜLER INTERIOR DIMENSIONS	FİYAT PRICE
12017122001	100x100x90 Uzunluk x genişlik x yükseklik	599 €
12017122004	140x140x105 Length x width x height	799 €

Öne Çıkan Özellikler Product Features

- » Filtrasyon elemanları montajına uygun ergonomik tasarım
- » Cam elyaf takviyeli polyester gövde
- » Çok dayanıklı yapıya sahip
- » UV dayanımlıdır, dış ortamda kullanılabilir
- » 100x100x90 mm; 350-600'lik filtreler için uygundur
- » 140x140x105 mm; 600-900'lük filtreler için uygundur
- » Ergonomic design suitable for installation of filtration elements
- » Fibre glass reinforced polyester
- » High durable structure
- » UV resistance, can be installed outside
- » 100x100x90 mm; It is suitable for 350-600 sand filters
- » 140x140x105 mm; It is suitable for 600-900 sand filters

Makina Dairesi Kapağı Cover For Machine Room



KOD CODE	UZUNLUK LENGHT	GENİŞLİK WIDTH	İÇTEN İÇE INTERIOR SIZES	DIŞTAN DIŞA OUTHER SIZES	FİYAT PRICE
12017121001	100 cm	100 cm	94x94	112x112	420 €
12017121005	80 cm	80 cm	81x81	104x104	320 €
12017121003	60 cm	60 cm	65x65	90x90	260 €
12017121015	50 cm	50 cm	45x45	58x58	240 €

Öne Çıkan Özellikler Product Features

- » Cam takviyeli polyester gövde
- » Çok dayanıklı yapıya sahip
- » UV dayanımlıdır dış ortamda kullanılabilir
- » Gri ve bej renk seçenekleri ile
- » Glass reinforced polyester body
- » High durable structure
- » UV resistance, can be installed outside
- » Grey and beige colors optionally

Makina Dairesi Merdiveni Polyester Filtration Room Ladder



KOD CODE	UZUNLUK LENGHT	GENİŞLİK WIDTH	BASAMAK STEP	FİYAT PRICE
12017121002	150 cm	45 cm	4	341 €

Öne Çıkan Özellikler Product Features

- » Cam takviyeli polyester gövde
- » Çok dayanıklı yapıya sahip
- » UV dayanımlıdır dış ortamda kullanılabilir
- » Glass reinforced polyester body
- » High durable structure
- » UV resistance, can be installed outside

Pompa Sehpası Plastik Pump Stand Plastic



KOD CODE	UZUNLUK LENGHT	GENİŞLİK WIDTH	YÜKSEKLİK HEIGHT	FİYAT PRICE
199002024	41,5 cm	25 cm	19 cm	11 €

Öne Çıkan Özellikler Product Features

- » PE plastik enjeksiyon ürün
- » Ekonomik alternatif
- » PE plastic injection product
- » Competitive price

Gözetleme Camı Inspection Glass



KOD CODE	BAĞLANTI CONNECTION	FİYAT PRICE
19811123010	50 mm	21 €
19811123011	63 mm	23.80 €
19811123012	75 mm	60.20 €
19811123013	90 mm	81.20 €
19811123014	110 mm	89.60 €

Öne Çıkan Özellikler Product Features

- » Akrilik şeffaf boru
- » U-PVC bağlantı rakoru ile verilir

- » Transparent acrylic pipe
- » Includes U-PVC unions

Pompa Sehpası Polyester Pump Stand Polyester



KOD CODE	UZUNLUK LENGHT	GENİŞLİK WIDTH	YÜKSEKLİK HEIGHT	FİYAT PRICE
199002023	46 cm	27 cm	18 cm	57 €

Öne Çıkan Özellikler Product Features

- » Cam takviyeli polyester gövde
- » UV ışınlarına dayanıklı
- » Çok dayanıklı yapı

- » Glass reinforced polyester body
- » UV resistance
- » High durable structure

HAVUZ İÇİ & ELEKTİRİK WHITE EQUIPMENT & LIGHTING



HAVUZ İÇİ VE ELEKTRİK EKİPMANLARI WHITE EQUIPMENT & LIGHTING

Havuz içi ve elektrik ekipmanlarda güvenilir ürünler.
Reliable products in in-pool and electrical equipment.

Skimmer'dan havuz lambasına, tüm detaylar tek çatı altında.
From skimmers to pool lights, every detail under one roof.

Havuz içi ve elektrikli ekipmanlar, yüzme deneyiminin konfor ve güvenliğini artırır.
Neta Havuz, her havuz tipine uygun dayanıklı ve verimli çözümler sunar.

*In-pool and electrical equipment enhance the comfort and safety of the swimming experience.
Neta Pool offers durable and efficient solutions for every pool type.*

Skimmer Skimmers

Eco Seri Liner & Beton Havuzlar Eco Serie For Liner & Concrete Pools

Eco seri skimmer
sepet ölçüsü:

Çap: 19,5 cm
En: 15,5 cm
Boy: 11 cm

Eco serie skimmer
basket dimensions:

Dia: 19,5 cm
Length: 15,5 cm
Width: 11 cm

Öne Çıkan Özellikler Product Features

- » ABS'den mamül, UV dayanıklı, güneşten etkilenmez
- » Flaş ve contalar ürün içerisinde
- » Kolay uygulanabilir
- » Daha keskin kıvrımlara ve bentlere sahip serbest havuzlar için idealdir
- » Ayrıca derinliği daha az ancak yüzey alanı daha fazla olan havuzlar içindir

- » UV resistant, unaffected by the sun
- » Produced from ABS plastic injection
- » Easy installation
- » Ideal for free pools with more acute bends and curves
- » Also for pools that have less depth but more surface area

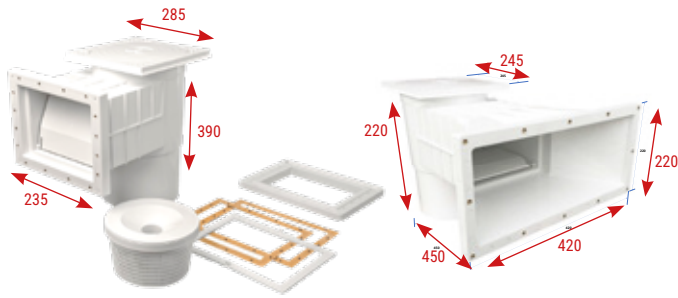

Liner

Beton Concrete

KOD CODE	MODEL MODEL	BAĞLANTI CONNECTION	ŞEKİL TYPE	FİYAT PRICE
12515123021	Liner	50/63 mm	Standart	70 €
12515123030	Liner	50/63 mm	Geniş Wide	85 €

KOD CODE	MODEL MODEL	BAĞLANTI CONNECTION	ŞEKİL TYPE	FİYAT PRICE
12515123020	Beton Concrete	50/63 mm	Standart	60 €
12515123031	Beton Concrete	50/63 mm	Geniş Wide	70 €

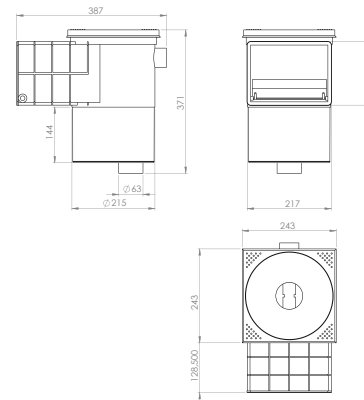
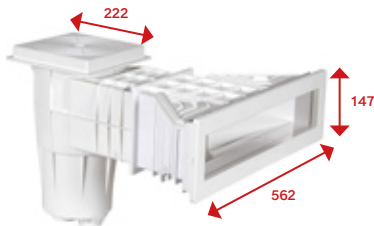

Liner & Beton Concrete & Liner

KOD CODE	BAĞLANTI CONNECTION	ŞEKİL TYPE	FİYAT PRICE
12515113007	50 mm	İnce Geniş Ağız Liner Thin Wide Liner	240 €

Skimmer Skimmers

Öne Çıkan Özellikler Product Features

- » Liner, polyester (fiberglass) ve beton havuzlar için uygundur
- » UV korumalı, beyaz enjeksiyon ABS malzemeden üretilmiştir
- » 1½" veya Ø63 mm giriş bağlantısı (5 m³/h veya 7,5 m³/h debi seçenekleri)
- » Ø32 mm taşma (overflow) bağlantısına sahiptir
- » EN 16582-1 ve EN 16713-2 standartlarına uygundur



Liner / Liner



Metal Takım / Metal Inserts



Beton / Concrete

Kripsol skimmer sepet ölçüsü:

Çap: 19,2 cm
En: 13,7 cm
Boy: 12,5 cm

Kripsol skimmer basket dimensions:

Dia: 19,2 cm
Length: 13,7 cm
Width: 12,5 cm

Beton Havuzlar Concrete Pools

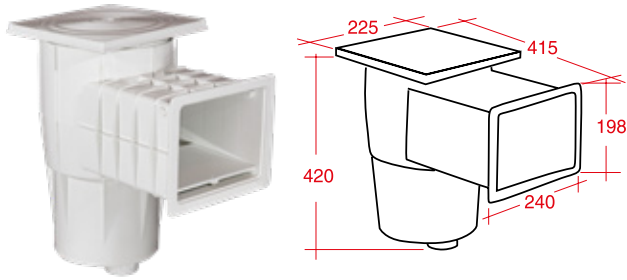

SKSL.C Model

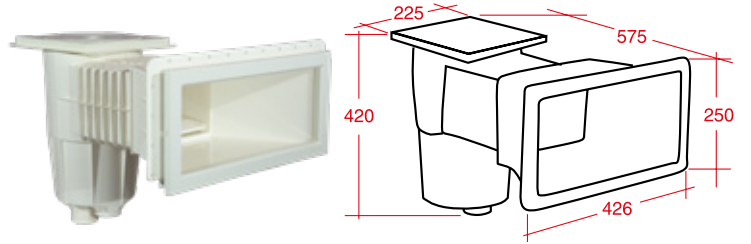

SKA.C Model

KOD CODE	MODEL MODEL	BAĞLANTI CONNECTION	ŞEKİL TYPE	FİYAT PRICE
12515113001	SKSL.C	50 mm	Standart	72 €

KOD CODE	MODEL MODEL	BAĞLANTI CONNECTION	ŞEKİL TYPE	FİYAT PRICE
12515113002	SKA.C	50 mm	Geniş Wide	105 €

Liner Havuzlar Liner Pools

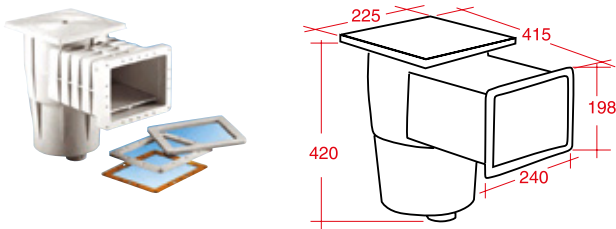

SKSL.C Model

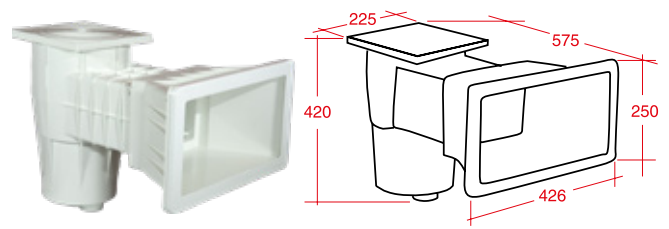

SKAL.C Model

Flanş ve contalar ürün içerisinde
Flange & gasket for liner pools included in the box

KOD CODE	MODEL MODEL	BAĞLANTI CONNECTION	ŞEKİL TYPE	FİYAT PRICE
12515113003	SKSL.C	50 mm	Standart	105 €

KOD CODE	MODEL MODEL	BAĞLANTI CONNECTION	ŞEKİL TYPE	FİYAT PRICE
12515113004	SKAL.C	50 mm	Geniş Wide	175 €

NEW

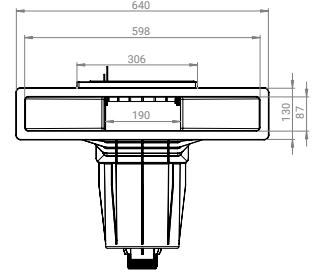
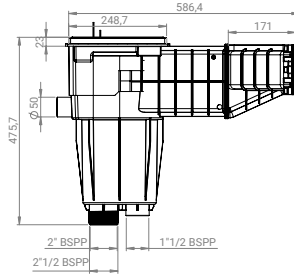

KOD CODE	MODEL MODEL	BAĞLANTI CONNECTION	ŞEKİL TYPE	FİYAT PRICE
12515113009	X PRO 60	50 mm	İnce Geniş Ağız Liner Thin Wide Liner	--



4 renk seçeneği
4 colour available

Smart Yüksek Su Seviyesi Skimmer, Model High 500, ABS, Beyaz, Pirinç Burçlu
Smart High Water Level Skimmer, Model High 500, ABS, White, with Brass Bushes

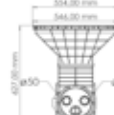
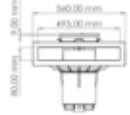
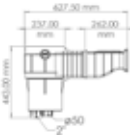

KOD CODE	BAĞLANTI CONNECTION	ŞEKİL TYPE	FİYAT PRICE
12515124001	50 mm	İnce Ağız Mirror Skimmer	455 €

Skimmer Skimmers

Liner & Beton Havuzlar
For Liner & Concrete Pools

Üretim Yeri / Manufacturing Location
Türkiye'de Üretilmiştir / Made in Turkey
Marka / Brand
Neta Havuz Ürünü / Neta Pool Product

Waterfun skimmer sepet ölçüsü:
Çap: 15,5 cm
En: 9,8 cm
Boy: 8,8 cm

Waterfun skimmer basket dimensions:
Dia: 15,5 cm
Length: 9,8 cm
Width: 8,8 cm

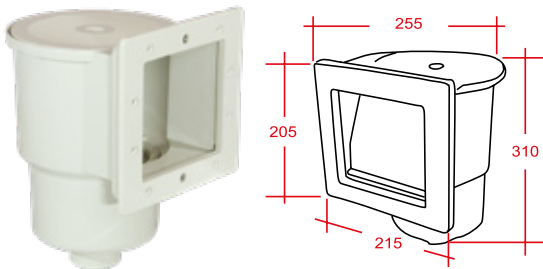

SKLK Model

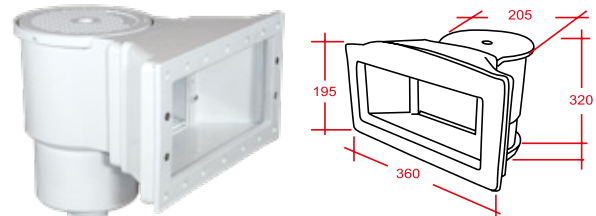

SKLG Model



Uzatma Parçası Extension Part

KOD CODE	MODEL MODEL	BAĞLANTI CONNECTION	ŞEKİL TYPE	FİYAT PRICE
12515123009	SKLK	50 mm	Standart	69 €
12515123010	SKLG	53 mm	Geniş Wide	70 €
19812123007	-	50 mm	Uzatma Parçası Extension Part	13€

Besleme & Vakum Nozulları

Inlet & Vacuum Nozzles

Beton Havuzlar Concrete Pools

Öne Çıkan Özellikler Product Features

- » ABS plastik enjeksiyon ürün
- » UV dayanıklıdır, güneşten etkilenmez
- » Oynar başlıklıdır, su istikameti istenilen açıda ayarlanabilir
- » Produced from ABS plastic injection
- » UV resistant, unaffected by the sun
- » Adjustable water direction

YANDAN BESLEME NOZULLARI WALL INLET NOZZLES



KOD CODE	RENK COLOR	ŞEKİL TYPE	ÇAP DIA	FİYAT PRICE
12517132019	Beyaz White	Yapıştırma Slip	Ø50	2.10 €
12517132021	Siyah Black ★	Yapıştırma Slip	Ø63	2.50 €
12517132020	Beyaz White	Yapıştırma Slip	Ø63	2.10 €
12517123001	Beyaz White	Yapıştırma Slip	Ø63	2.55 €
12517123002	Beyaz White	Dişli Threaded	Ø63	3.50 €
12517132001	Beyaz White	Yapıştırma Slip	Ø63	2.00 €



KOD CODE	ÜRÜN ADI PRODUCT	ŞEKİL TYPE	ÇAP DIA	FİYAT PRICE
12517132009	Besleme Nozulu Inlet Nozzle	Yapıştırma Slip	Ø50	2.89 €

- » Açı ayarlı mafsallı bağlanır
- » Adjustable angle jointed

TABANDAN BESLEME NOZULLARI FLOOR INLET NOZZLES



KOD CODE	RENK COLOR	ŞEKİL TYPE	ÇAP DIA	FİYAT PRICE
12517132016	Beyaz White	Yapıştırma Slip	Ø50	2.40 €
12517132002	Siyah Black	Yapıştırma Slip	Ø63	2.00 €
1014999100	Beyaz White	Konik Adj. Conic	Ø63	5.40 €



KOD CODE	RENK COLOR	ŞEKİL TYPE	ÇAP DIA	FİYAT PRICE
12517132015	Beyaz <i>White</i>	Yapıştırma <i>Slip</i>	Ø50	2.25 €
12517132003	Beyaz <i>White</i>	Yapıştırma <i>Slip</i>	Ø63	2.50 €
12517132013	★ Siyah <i>Black</i>	Konik Adj. <i>Conic</i>	Ø63	3.00 €

- » Debi ayarlıdır
- » Flow rate adjustable



KOD CODE	ÜRÜN ADI PRODUCT	ŞEKİL TYPE	ÇAP DIA	FİYAT PRICE
12517132005	Besleme Nozulu <i>Inlet Nozzle</i>	Tabandan Floor <i>Yapıştırma Slip</i>	Ø63	2.99 €

- » Açı ayarlıdır
- » Adjustable angle jointed

VAKUM NOZULLARI VACUUM NOZZLES



KOD CODE	RENK COLOR	ŞEKİL TYPE	ÇAP DIA	FİYAT PRICE
12517132017	Beyaz <i>White</i>	Vakum <i>Vacuum</i> / Yapıştırma <i>Slip</i>	Ø50	2.00 €
12517132004	Beyaz <i>White</i>	Vakum <i>Vacuum</i> / Yapıştırma <i>Slip</i>	Ø63	2.00 €
12517132014	Siyah <i>Black</i>	Vakum <i>Vacuum</i> / Yapıştırma <i>Slip</i>	Ø63	2.50 €

Liner Havuzlar

Liner Pools

Öne Çıkan Özellikler Product Features

- » ABS plastik enjeksiyon ürün
- » UV dayanıklıdır, güneşten etkilenmez
- » Debi ayarlıdır
- » 63 mm boruya uygulanır
- » Produced from ABS plastic injection
- » UV resistant, unaffected by the sun
- » Flow rate adjustable
- » 63 mm pipe connection



KOD CODE	ÜRÜN ADI PRODUCT	ŞEKİL TYPE	ÇAP DIA	FİYAT PRICE
12517113001	Besleme Nozulu Inlet Nozzle	Tabandan Floor Dişli Threaded	Ø63	26 €



Flanş ve contalar ürün içerisindedir. Açı ayarlı su çıkışı.
Flange & gasket for liner pools included in the box.
Angle adjustable water outlet

KOD CODE	ÜRÜN ADI PRODUCT	ŞEKİL TYPE	ÇAP DIA	FİYAT PRICE
12517113002	Besleme Nozulu Inlet Nozzle	Yandan Wall Dişli Threaded	Ø63	17.50 €



KOD CODE	ÜRÜN ADI PRODUCT	ŞEKİL TYPE	ÇAP DIA	FİYAT PRICE
12517132012	Besleme Nozulu Inlet Nozzle	Yandan Wall Yapıştırma Slip	Ø63	15 €
12517113004	Besleme Nozulu Inlet Nozzle	Yandan Wall Yapıştırma Slip	Ø50	15 €



3 mm içten dişli veya 50 mm dıştan dişli bağlantılı. Açı ayarlı su çıkışı.
50 mm male or 63 mm female threaded connection.
Angle adjustable water outlet

KOD CODE	ÜRÜN ADI PRODUCT	ŞEKİL TYPE	ÇAP DIA	FİYAT PRICE
12517123012	Besleme Nozulu Inlet Nozzle	Yandan Wall Dişli Threaded	Ø50	11 €

Öne Çıkan Özellikler *Product Features*

- » Gövde ABS plastik enjeksiyondan üretilmiş
- » AISI 316 paslanmaz çelik önyüz
- » Açılı ayarlı su çıkışı
- » 63 mm boruya uygulanır
- » Body produced from ABS plastic injection
- » AISI 316 stainless steel face plate
- » Angle adjustable water outlet
- » 63 mm pipe connection



AISI 304 paslanmaz çelik önyüz.

Yapıştırma olarak montaj edilebilir, debi ayarlıdır.

AISI 304 stainless steel face plate. Slip connection, adjustable.

KOD CODE	ÜRÜN ADI PRODUCT	ŞEKİL TYPE	ÇAP DIA	FİYAT PRICE
12517132007	Besleme Nozulu <i>Inlet Nozzle</i>	Tabandan Floor <i>Yapıştırma Slip</i>	Ø63	55 €



Yapıştırma olarak montaj edilebilir.

Slip connection.

KOD CODE	ÜRÜN ADI PRODUCT	ŞEKİL TYPE	ÇAP DIA	FİYAT PRICE
12517123010	Besleme Nozulu <i>Inlet Nozzle</i>	Tabandan Floor <i>Yapıştırma Slip</i>	Ø63	45 €



Yapıştırma olarak montaj edilebilir.

Slip connection.

KOD CODE	ÜRÜN ADI PRODUCT	ŞEKİL TYPE	ÇAP DIA	FİYAT PRICE
12517132008	Vakum Nozulu <i>Vacuum Nozzle</i>	Tabandan Floor <i>Yapıştırma Slip</i>	Ø63	45 €

Dip Süzgeçleri Drains

Beton Havuzlar Concrete Pools

Öne Çıkan Özellikler Product Features

- » ABS plastik enjeksiyondan üretilmiş
 - » Güçlü ve sağlam gövde yapısına sahiptir
 - » Bağlantı çapı 2" (63 mm)
 - » Gövde çapı: 180 mm
 - » UV dayanıklıdır, güneşten etkilenmez
- » Produced from ABS plastic injection
 - » Strong and durable body structure
 - » Connection diameter: 2" (63 mm)
 - » Body diameter: 180 mm
 - » UV resistant, unaffected by the sun



KOD CODE	ÜRÜN ADI PRODUCT	ŞEKİL TYPE	ÇAP DIA	FİYAT PRICE
12518123001	Dip Süzgeci Round Drain	Dişli Threaded	Ø63	20 €

KOD CODE	ÜRÜN ADI PRODUCT	ŞEKİL TYPE	ÇAP DIA	FİYAT PRICE
12518113001	Dip Süzgeci Round Drain	Dişli Threaded	Ø63	25 €

Üretim Yeri / Manufacturing Location

Türkiye'de Üretilmiştir / Made in Turkey

Marka / Brand

Neta Havuz Ürünü / Neta Pool Product



Marka / Brand

Dünya Markası / Global Brand



Liner Havuzlar Liner Pools



Gövde çapı 210 mm.
Body diameter: 210 mm.

Gövde çapı 218 mm.
Body diameter: 218 mm.

KOD CODE	ÜRÜN ADI PRODUCT	ŞEKİL TYPE	ÇAP DIA	FİYAT PRICE
12518123002	Besleme Nozulu Inlet Nozzle	Yandan Dişli Wall Threaded	Ø63	45 €

KOD CODE	ÜRÜN ADI PRODUCT	ŞEKİL TYPE	ÇAP DIA	FİYAT PRICE
12518113002	Besleme Nozulu Inlet Nozzle	Yandan Dişli Wall Threaded	Ø63	50 €

Üretim Yeri / Manufacturing Location

Türkiye'de Üretilmiştir / Made in Turkey

Marka / Brand

Neta Havuz Ürünü / Neta Pool Product



Marka / Brand

Dünya Markası / Global Brand



Beton Ara Parçası Concrete Wall Conduit



KOD CODE	BOY SIZE	AĞIRLIK WEIGHT	ÇAP DIA	FİYAT PRICE
12516123001	300 mm	0,20 Kg	Ø63	7.20 \$
12516113001 Dişli Threaded	300 mm	0,20 Kg	Ø63	10.50 €

Öne Çıkan Özellikler Product Features

- » ABS plastik enjeksiyondan üretilmiş
- » İnşaat esnasında betona konulur
- » Olası bozukluk ve tıkanıklıklara karşı nozulları korumak amacıyla kullanılır
- » Produced from ABS plastic injection
- » This component is embedded in concrete during the construction work, thus preserving the nozzles from possible jamming or deterioration due to concrete

Dip Süzgeç Kapakları Drains Cover

Üretim Yeri / Manufacturing Location
Türkiye'de Üretilmiştir / Made in Turkey
Marka / Brand
Neta Havuz Ürünü / Neta Pool Product

Beton Havuzlar Concrete Pools

Öne Çıkan Özellikler Product Features

- » ABS plastik enjeksiyondan üretilmiştir
- » Güçlü ve sağlam gövde yapısına sahiptir
- » UV dayanıklıdır, güneşten etkilenmez
- » Produced from ABS plastic injection
- » Strong and durable body structure
- » UV resistant, unaffected by the sun



KOD CODE	ÜRÜN ADI PRODUCT	ÖLÇÜ DIMENSION	FİYAT PRICE
12518121001	Kare Dip Süzgeç Kapağı Square Drain Cover	265x265 mm	9.00 €
12518121002	Kare Dip Süzgeç Kapağı Square Drain Cover	300x300 mm	11.0 €

KOD CODE	ÜRÜN ADI PRODUCT	ÖLÇÜ DIMENSION	FİYAT PRICE
12518123006	Yuvarlak Dip Süzgeç Kapağı Round Drain Cover	Ø240 mm	11.00 €

50, 63, 90 mm çaplarında kullanılabilir.
Can be used in dia of 50, 63, 90 mm.



KOD CODE	ÜRÜN ADI PRODUCT	ÖLÇÜ DIMENSION	FİYAT PRICE
12518121003	Dikdörtgen Dip Süzgeç Kapağı Rectangle Drain Cover	100x200 mm	9.52 €

Beton ve Liner Havuzlar Concrete and Liner Pools

Üretim Yeri / Manufacturing Location
Türkiye'de Üretilmiştir / Made in Turkey

Marka / Brand
Neta Havuz Ürünü / Neta Pool Product

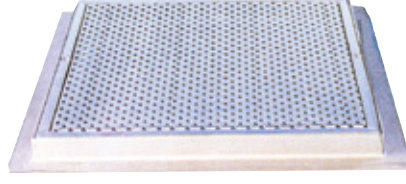

AISI 304 paslanmaz çelik.
AISI 304 stainless steel..

KOD CODE	ÜRÜN ADI PRODUCT	ÖLÇÜ mm SIZE mm	FİYAT PRICE
12518122004	Süzgeç Kapağı Paslanmaz Çelik <i>Drain Cover Stainless Steel</i>	20x20	110 €
148122010	Süzgeç Kapağı Paslanmaz Çelik <i>Drain Cover Stainless Steel</i>	25x25	130 €
12518122013	Süzgeç Kapağı Paslanmaz Çelik <i>Drain Cover Stainless Steel</i>	26,5x26,5	135 €
12518122005	Süzgeç Kapağı Paslanmaz Çelik <i>Drain Cover Stainless Steel</i>	30x30	155 €
12518122011	Süzgeç Kapağı Paslanmaz Çelik <i>Drain Cover Stainless Steel</i>	45x45	170 €
12518122007	Süzgeç Kapağı Paslanmaz Çelik <i>Drain Cover Stainless Steel</i>	50x50	180 €
12518122008	Süzgeç Kapağı Paslanmaz Çelik <i>Drain Cover Stainless Steel</i>	55x55	190 €
12518122010	Süzgeç Kapağı Paslanmaz Çelik <i>Drain Cover Stainless Steel</i>	60x60	200 €

Su Seviye Regülatörü Water Level Regulator

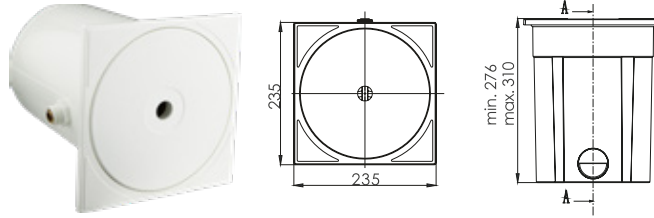

KOD CODE	BAĞLANTI CONNECTION	DEBİ L/DK FLOWRATE LT/MIN	FİYAT PRICE
2099002418	Inlet: $\phi 20$ mm veya or 3/4" BSP, Outlet: $\phi 50$ mm	30-50	52 €

Aydınlatmalar *Lighting*

Neta Havuz, her tip ve boyuttaki havuz için (beton, liner, polyester) uyumlu LED çözümler sunar. Beyaz veya RGB seçenekleriyle havuzunuza istediğiniz atmosferi kazandırabilirsiniz.

Neta Pool provides LED solutions compatible with all types and sizes of pools (concrete, liner, polyester). With white or RGB options, you can create the perfect atmosphere for your pool.



Par 56 Ampüller Bulbs With Led Par 56

Öne Çıkan Özellikler Product Features

- » PAR 56 LED ampul
- » Geniş açılı polikarbonat ön cam
- » POWERLED
- » Su altında çalışmaya uygun
- » Uzun ömürlü ve uygun fiyat
- » PAR 56 LED bulbs
- » Large angle wind screen from polycarbonate
- » POWERLED
- » Suitable for under water
- » Long lasting and competitive price



KOD CODE	ÜRÜN ADI PRODUCT NAME	RENK COLOR	GÜÇ POWER	FİYAT PRICE
12519122139	JSMD-L06 POWERLED	Sıcak Beyaz Warm White	20w-12v	34 €
12519122140	JSMD-L07 POWERLED	Buz Beyaz Cold White	20w-12v	34 €
12519122151	JSMD-L08 POWERLED	Mavi Blue	20w-12v	34 €



54 SMD ledli.

54 SMD leds.

KOD CODE	ÜRÜN ADI PRODUCT NAME	RENK COLOR	GÜÇ POWER	FİYAT PRICE
12519122136	JSMD-L10 SMD LED	Sıcak Beyaz Warm White	30w-12v	38 €
12519122135	JSMD-L11 SMD LED	Buz Beyaz Cold White	30w-12v	38 €
12519122093	JSMD-L12 SMD LED	Mavi Blue	30w-12v	38 €
12519122090	JSMD-L13 SMD LED	RGB 4 Kablolu RGB 4 Cores	30w-12v	53 €
12519122150	JSMD-L13 SMD LED	RGB 2 Kablolu RGB 2 Cores	30w-12v	57 €



54 SMD ledli.
54 SMD leds.

KOD CODE	RENK COLOR	GÜÇ POWER	FİYAT PRICE
PLGPAR563012WCA	Soğuk Beyaz <i>Cold White</i>	30w-12v	30 €
PLGPAR563012WW	Sıcak Beyaz <i>Warm White</i>	30w-12v	30 €
PLGPAR563012BL	Mavi <i>Blue</i>	30w-12v	30 €
PLGPAR5630124RGB	RGB 4 Kablolu <i>RGB 4 Cores</i>	30w-12v	33 €
PLGPAR5630122RGB	RGB 2 Kablolu <i>RGB 2 Cores</i>	30w-12v	55,5 €

Par 56 PowerLed Ampüller Bulbs With Power Led Par 56

Öne Çıkan Özellikler *Product Features*

- » Gövde çapı 177x82 mm
- » Geniş açılı polikarbonat ön cam
- » CREE dünya markası power LED
- » Alüminyum-magnezyum karışım alaşım gövde
- » Nokta korozyona dayanıklı
- » Su soğutmalı, sadece su altında kullanılır
- » 12 V 50/60 Hz IP 68 su sızdırmazlık
- » **Piyasadaki en kaliteli su altı Power LED Ampul**
- » Body diameters 177x82 mm
- » Large angle wind screen from polycarbonate
- » CREE global brand power LED
- » Aluminum-magnesium mixed alloy body
- » Spot corrosion resistant
- » Water cooled, can be used only under water
- 12 V 50/60 Hz IP 68 waterproof
- **Best quality underwater Power LED bulb** in the market



KOD CODE	RENK COLOR	GÜÇ POWER	FİYAT PRICE
12519122012	Sıcak Beyaz <i>Warm White</i>	27.8w-12v	118 \$
12519122013	Soğuk Beyaz <i>Cold White</i>	27.8w-12v	118 \$
12519122014	Doğal Beyaz <i>Natural White</i>	27.8w-12v	118 \$
12519122015	Kırmızı <i>Red</i>	13w-12v	118 \$
12519122016	Yeşil <i>Green</i>	15w-12v	118 \$
12519122017	Mavi <i>Blue</i>	15w-12v	118 \$

Sıva Üstü Ledli Flat Type Led Lights

Öne Çıkan Özellikler Product Features

- » Beton havuzlar içindir
- » Havuz kaplama (cam, seramik ve mozaik) üzerine montaj edilir
- » Su soğutmalı, sadece su altında kullanılır
- » Geniş açılı polikarbonat ön cam
- » For concrete pools
- » Mounted on the pool covering (like as glass, ceramic and mosaic tiles)
- » Water cooled, can be used only under water
- » Large angle wind screen from polycarbonate



KOD CODE	RENK COLOR	GÜÇ POWER	FİYAT PRICE
12519122137	Gün Işığı <i>Day Light</i>	30w-12v 84 SMD LED	48 €
12519122138	Buz Beyaz <i>Cold White</i>	30w-12v 84 SMD LED	48 €
12519122097	Mavi <i>Blue</i>	30w-12v 84 SMD LED	48 €
12519122092	RGB 4 Damarlı <i>RGB 4 Cores</i>	30w-12v 84 SMD LED	69 €
12519122149	RGB 2 Damarlı <i>RGB 2 Cores</i>	30w-12v 84 SMD LED	79 €



KOD CODE	RENK COLOR	GÜÇ POWER	FİYAT PRICE
12519122118	Gün Işığı <i>Day Light</i>	20w-12v 84 SMD LED	44 €
12519122119	Buz Beyaz <i>Cold White</i>	20w-12v 84 SMD LED	44 €
12519122071	Mavi <i>Blue</i>	20w-12v 84 SMD LED	44 €



KOD CODE	RENK COLOR	GÜÇ POWER	FİYAT PRICE
PLG1F3012WC	Soğuk Beyaz <i>Cold White</i>	30W / 12V SMD LED	36 €
PLG1F3012WW	Sıcak Beyaz <i>Warm White</i>	30W / 12V SMD LED	36 €
PLG1F3012BL	Mavi <i>Blue</i>	30W / 12V SMD LED	36 €
PLG1F3012RGB	RGB 4 Damarlı <i>RGB 4 Cores</i>	30W / 12V SMD LED	48 €
PLG1F3022RGB	RGB 2 Damarlı <i>RGB 2 Cores</i>	30W / 12V SMD LED	60 €



KOD CODE	RENK COLOR	GENİŞLİK WIDTH	GÜÇ POWER	FİYAT PRICE
PLG1FK3012WC	Soğuk Beyaz <i>Cold White</i>	28 cm	30W / 12V SMD LED	42 €
PLG1FK3012WW	Sıcak Beyaz <i>Warm White</i>	28 cm	30W / 12V SMD LED	42 €
PLG1FK3012BL	Mavi <i>Blue</i>	28 cm	30W / 12V SMD LED	42 €
PLG1FK43012RGB	RGB 4 Damarlı <i>RGB 4 Cores</i>	28 cm	30W / 12V SMD LED	48 €
PLG1FK23012RGB	RGB 2 Damarlı <i>RGB 2 Cores</i>	28 cm	30W / 12V SMD LED	56 €



KOD CODE	RENK COLOR	GENİŞLİK WIDTH	GÜÇ POWER	FİYAT PRICE
PLG1FK1012WCA	Soğuk Beyaz <i>Cold White</i>	15 cm	10W / 12V SMD LED	32 €
PLG1FK10/12WW	Sıcak Beyaz <i>Warm White</i>	15 cm	10W / 12V SMD LED	32 €
PLG1FK1012RGB	RGB 4 Damarlı <i>RGB 4 Cores</i>	15 cm	10W / 12V SMD LED	38 €
PLG1FK612WCA	Soğuk Beyaz <i>Cold White</i>	12 cm	6W / 12V SMD LED	30 €
PLG1FK612WW	Sıcak Beyaz <i>Warm White</i>	12 cm	6W / 12V SMD LED	30 €
PLG1FK612RGB	RGB 4 Damarlı <i>RGB 4 Cores</i>	12 cm	6W / 12V SMD LED	36 €



15 cm



12 cm

KOD CODE	RENK COLOR	GENİŞLİK WIDTH	GÜÇ POWER	FİYAT PRICE
PLG0FK1012WCA	Soğuk Beyaz <i>Cold White</i>	15 cm	10W / 12V SMD LED	29 €
PLG0FK10/12WW	Sıcak Beyaz <i>Warm White</i>	15 cm	10W / 12V SMD LED	29 €
PLG0FK1012RGB	RGB 4 Damarlı <i>RGB 4 Cores</i>	15 cm	10W / 12V SMD LED	35€
PLG1FK712WCA	Soğuk Beyaz <i>Cold White</i>	12 cm	6W / 12V SMD LED	27 €
PLG1FK712WW	Sıcak Beyaz <i>Warm White</i>	12 cm	6W / 12V SMD LED	27 €
PLG1FK712RGB	RGB 4 Damarlı <i>RGB 4 Cores</i>	12 cm	6W / 12V SMD LED	33 €



Joker Model Led Lamba *Joker Model Led Light*

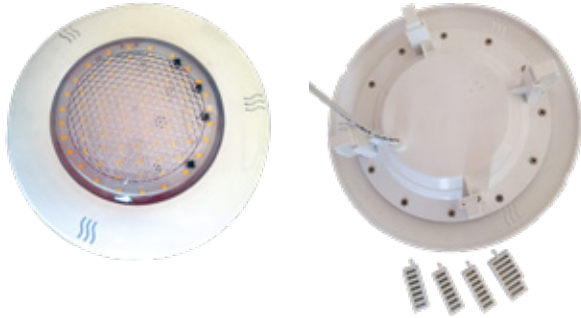

KOD CODE	RENK COLOR	GÜÇ POWER	FİYAT PRICE
12519122144	Buz Beyaz <i>Cold White</i>	30W/12V SMD LED	62 €
12519122145	Gün Işığı <i>Day Light</i>	30W/12V SMD LED	62 €
12519122146	Mavi <i>Blue</i>	30W/12V SMD LED	62 €
12519122147	RGB	30W/12V SMD LED	81 €

Öne Çıkan Özellikler *Product Features*

- » C ve DC voltajla çalışmaktadır
- » Üzerinde bulunan aparatlar sayesinde iç çapı Ø19-Ø21-Ø23 cm olan tüm lamba kovanları ile uyumludur
- » Sadece kablo ekini yapıp lambayı yerine takmanız yeterlidir

- » Works with AC and DC voltage
- » It is compatible with all light niches with inner diameter Ø19-Ø21-Ø23 cm thanks to the apparatus on it
- » Easy only to connect the cable and replace than install the light

Ledli Sıva Altı Lamba Underwater Led Light Niche Type

Öne Çıkan Özellikler Product Features

- » Beton ve liner havuzlar içindir
- » Havuz kaplama (cam, seramik ve mozaik) üzerine montaj edilir
- » Su soğutmalıdır, sadece su altında kullanılır
- » Geniş açılı polikarbonat ön cam
- » For concrete and liner pools
- » Mounted on the pool covering (like as glass, ceramic and mosaic tiles)
- » Water cooled, can be used only under water
- » Large angle wind screen from polycarbonate



KOD CODE	MODEL MODEL	RENK COLOR	GÜÇ POWER	FİYAT PRICE
12519122102	Beton Concrete	Mavi Blue	30W/12V	62 €
12519122094	Beton Concrete	Soğuk Beyaz Cold White	30W/12V	62 €
12519122142	Beton Concrete	Sıcak Beyaz Warm White	30W/12V	62€
12519122104	Beton Concrete	RGB 4 Damarlı RGB 4 Cores	30W/12V	72 €
12519122164	Beton Concrete	RGB 2 Damarlı RGB 2 Cores	30W/12V	76 €
12519122157	Liner	Mavi Blue	30W/12V	67 €
12519122156	Liner	Soğuk Beyaz Cold White	30W/12V	67 €
12519122155	Liner	Sıcak Beyaz Warm White	30W/12V	67 €
12519122148	Liner	RGB 4 Damarlı RGB 4 Cores	30W/12V	84 €
12519122161	Liner	RGB 2 Damarlı RGB 2 Cores	30W/12V	88 €



KOD CODE	MODEL MODEL	RENK COLOR	GÜÇ POWER	FİYAT PRICE
12519122159	Beton Concrete	Gün Işığı Day Light	20W / 12v POWERLED	52 €
12519122154	Beton Concrete	Buz Beyaz Cold White	20W / 12v POWERLED	52 €
12519122158	Beton Concrete	Mavi Blue	20W / 12v POWERLED	52€
12519122128	Liner	Gün Işığı Day Light	20W / 12v POWERLED	70 €
12519122160	Liner	Buz Beyaz Cold White	20W / 12v POWERLED	70 €
12519122131	Liner	Mavi Blue	20W / 12v POWERLED	70 €

Slimfit Kovanlı Led Lamba Slimfit Niche Type Led Light

- » Tüm kovan çaplarına uyumlu Jokerlidir.
- » Slimfit lamba ile kovan ayrı olarak sipariş verilmektedir.
- » Kovan dış çapı 21 cm'den 24 cm'e doğru genişlemektedir
- » Joker Light - compatible with all niche diameters.
- » Slimfit Light and niche are ordered separately.
- » The outer diameter expands from 21 cm to 24 cm



KOD CODE	MODEL MODEL	RENK COLOR	GÜÇ POWER	DERİNLİK ÖLÇÜSÜ POWER	FİYAT PRICE
PLG1S1812RGB4C	Slim Led	RGB	18W/12V	-	54.00 €
PLG1S3012WC	Slim Led	Soğuk Beyaz Cold White	30W/12V	-	45.00 €
PLG1S3012BL	Slim Led	Mavi Blue	30W/12V	-	45.00 €
19812122019	Yedek Dış Tası Niche Spare Part	-	-	7 cm	9.00€
19812122004	Yedek Dış Tası Niche Spare Part	-	-	13 cm	9.00 €



3 Power Ledli Spot Lamba 3 Power Led Spot Light



Boruya geçmeli Ø63 mm.
Solvent Internal for Ø63 mm.

KOD CODE	MODEL MODEL	RENK COLOR	GÜÇ POWER	FİYAT PRICE
17517122011	Damla Model <i>Drop Type</i>	Soğuk Beyaz <i>Cold White</i>	5W / 12v	47 €
17517122021	Damla Model <i>Drop Type</i>	Gün Işığı <i>Day Light</i>	5W / 12v	47 €
17517122022	Damla Model <i>Drop Type</i>	Mavi <i>Blue</i>	5W / 12v	47 €
17517122031	Damla Model <i>Drop Type</i>	RGB 2 Damarlı <i>RGB 2 Cores</i>	9W / 12v	84 €
17517122024	Damla Model <i>Drop Type</i>	RGB 4 Damarlı <i>RGB 4 Cores</i>	9W / 12v	55 €
17517122050	Düz Görümlü <i>Smooth Type</i>	Soğuk Beyaz <i>Cold White</i>	5W / 12v	63 €
17517122051	Düz Görümlü <i>Smooth Type</i>	Sıcak Beyaz <i>Warm White</i>	5W / 12v	63 €
17517122052	Düz Görümlü <i>Smooth Type</i>	Mavi <i>Blue</i>	5W / 12v	63 €
17517122033	Paslanmaz <i>Stainless</i>	Mavi <i>Blue AISI 316 Frame</i>	5W / 12v	75 €
17517122037	Paslanmaz <i>Stainless</i>	Soğuk Beyaz <i>Cold White AISI 316 Frame</i>	5W / 12v	75 €
17517122038	Paslanmaz <i>Stainless</i>	Gün Işığı <i>Day Light AISI 316 Frame</i>	5W / 12v	75 €
17517122041	Paslanmaz <i>Stainless</i>	RGB <i>AISI 316 Frame</i>	9W / 12v	84 €



Spot ayaklı.
Spot footed light.

KOD CODE	MODEL MODEL	RENK COLOR	GÜÇ POWER	FİYAT PRICE
17517122026	Spot Ayaklı <i>Spot Footed</i>	Beyaz <i>White</i>	5W / 12v	51 €
17517122027	Spot Ayaklı <i>Spot Footed</i>	Gün Işığı <i>Day Light</i>	5W / 12v	51 €
17517122028	Spot Ayaklı <i>Spot Footed</i>	Mavi <i>Blue</i>	5W / 12v	51 €
17517122030	Spot Ayaklı <i>Spot Footed</i>	RGB 2 Damarlı <i>RGB 2 Cores</i>	5W / 12v	86 €
17517122029	Spot Ayaklı <i>Spot Footed</i>	RGB 4 Damarlı <i>RGB 4 Cores</i>	5W / 12v	58 €

Lamba Buatı Junction Box



KOD CODE	MODEL MODEL	FİYAT PRICE
19812123008	WF.LB	12 €

Öne Çıkan Özellikler *Product Features*

- » Havuz terasına gömülerek su altı aydınlatma armatürlerinin kablo geçişine müdahale olanağı sağlar
- » ABS plastik enjeksiyon gövde
- » UV dayanıklıdır, güneşten etkilenmez
- » By sinking into the pool terrace; It provides the opportunity to interfere with the cable passage of underwater lighting fixtures
- » ABS plastic injection body
- » UV resistant, unaffected by the sun

Esnek Kablo Kılıf Hortumu Flexible Conduit Hose



KOD CODE	ÖLÇÜ DIAMETER	FİYAT PRICE
15017002035	1 mt	1.95 €
15017002036	1,5 mt	2.25 €

Öne Çıkan Özellikler *Product Features*

- » Kablo kılıf hortumu, lamba buatı ile lamba kovanının bağlantı sağlaması ve kablo koruması için kullanılır
- » İki ucu yapıştırmalı plastik adaptörlü
- » 19-20-21 mm iç çap opsiyonlu üretim mevcuttur
- » Cable conduit to link the light's niche with the connection box
- » Plastic Adaptor - Slip connection for both ends
- » 19-20-21 mm inner adaptor dia is possible for production

RGB Kontrol Paneli & Uzaktan Kumanda RGB Control Panel & Remote Control



KOD CODE	MODEL MODEL	FİYAT PRICE
15015122013	8 LAMBA LAMPS	190 €
169002008	16 LAMBA LAMPS	250 €
15015122014	24 LAMBA LAMPS	330 €
15015122015	32 LAMBA LAMPS	400 €

Öne Çıkan Özellikler Product Features

- » Plastik enjeksiyondan üretilmiştir
- » Paslanmaya dayanıklıdır
- » Uzaktan kumandalıdır
- » 4 ana renk ve animasyon programlıdır
- » Produced from ABS plastic injection
- » Corrosion-resistant
- » With remote control
- » 4 main colors and animation programs

RGB 2 Damarlı Kumanda Remote Control For RGB 2 Cores



KOD CODE	FİYAT PRICE
MUH.121	40 €

Trafo Transformer



Öne Çıkan Özellikler Product Features

- » Polipropilen plastik enjeksiyon gövde
- » Kapaklı elektrik bağlantı kutusu
- » Çalışmayı gösteren kırmızı led sinyal
- » Kendinden sigorta korumalı
- » Şık tasarım
- » Uzun ömürlü, kolay montaj
- » PP plastic injection body
- » Protected power connection with lid
- » Led indicator
- » With fuse
- » Stylish design
- » Long lasting, easy to install

KOD CODE	GÜÇ POWER	FİYAT PRICE
TRAF0-50-220-12-PLS-WF	50W - 12v	33 €
15016121001	100W - 12v	34 €
15016121002	100W - 24v	38 €
15016121003	150W - 12v	35 €
15016121004	150W - 24v	40 €
15016121005	300W - 12v	39 €
15016121006	300W - 24v	45 €
15016121007	400W - 12v	47 €
15016121008	400W - 24v	50€
15016121009	600W - 12v	89 €
15016121010	600W - 24v	90 €

Karşı Akıntı Ekipmanları

Stream Equipments

Komple Jet Stream Set Comple Jet Stream Set

Takıma Dahil Olanlar Sets Includes

- » Pompa » Pump
- » Beton ara parçaları » Concrete wall conduits
- » Ön gövde » Front part
- » Kumanda panosu » Control box



KOD CODE	ÖLÇÜ DIAMETER	FİYAT PRICE
12520123003	Jet Stream komple set beton Sena Model	--
12520123004	Jet Stream komple set liner Sena Model	--
12520123005	Jet Stream komple set beton Calipso Model	--



Komple Ön Parça

Jet Stream Front Body

Öne Çıkan Özellikler Product Features

- » Güçlü pompası ile karşısında yüzülebilecek kadar akıntı sağlar
- » 12520113010 masaj hortumu ile kullanılması tavsiye edilir
- » BS plastik enjeksiyon gövde
- » Yüksek UV ve kimyasal dayanımlıdır, güneşten etkilenmez
- » Açılabilir jet nozulu

- » With its powerful pump, it provides enough flow to swim against
- » Recommended to use with massage hose in code 12520113010
- » ABS plastic injection body
- » High UV and chemical resistant, unaffected by the sun
- » Angle adjustable jet nozzle



Sena Model



Calipso Model



LED

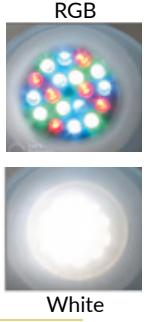

White

KOD CODE	MODEL ADI MODEL NAME	MODEL MODEL	FİYAT PRICE
12520113014	Sena	JS1.B	721 €
12520113013	Calipso	JC1.B	975 €
12520123006	LED RGB	--	876 €
12520123007	LED Beyaz LED White	--	876 €

Karşı Akıntı Pompası Karpa KA

Jet Stream Pump Karpa KA



KOD CODE	GÜÇ HP POWER HP	FİYAT PRICE
11515113122	2.50 HP Trifaze <i>Triphase</i>	1.120 €
11515113124	3.00 HP Trifaze <i>Triphase</i>	1.170 €
11515113125	3.50 HP Trifaze <i>Triphase</i>	1.230 €
11515113126	4.50 HP Trifaze <i>Triphase</i>	1.290 €
11515113127	5.50 HP Trifaze <i>Triphase</i>	1.350 €

Beton Ara Parçası Concrete Wall Conduit



KOD CODE	HAVUZ TİPİ POOL TYPE	MODEL MODEL	FİYAT PRICE
12520113012	Beton Concrete	JSH2.B	253 €
12520113004	Liner	JSL2.B	253 €

Öne Çıkan Özellikler Product Features

- » Ekstra güçlü gövde
- » ABS plastik enjeksiyon gövde
- » Yüksek UV ve kimyasal dayanımlıdır, güneşten etkilenmez
- » Extra strong body
- » ABS plastic injection body
- » High UV and chemical resistant, unaffected by the sun

Kit Up Gövde Jet Stream Kit Up Body



KOD CODE	HAVUZ TİPİ POOL TYPE	MODEL MODEL	FİYAT PRICE
12520113005	Beton Concrete	BCH.B	232 €
12520113006	Liner	BCL.B	253 €

Öne Çıkan Özellikler Product Features

- » Masaj hortumu ile beraber
- » 12520113007 Emiş nozulu ile beraber alınmalıdır
- » Ekstra güçlü gövde
- » Beton ara parçası gerektirmez
- » ABS plastik enjeksiyon gövde
- » Yüksek UV ve kimyasal dayanımlıdır, güneşten etkilenmez
- » Including in massage hose
- » It should be purchased together with the suction nozzle in code 12520113007
- » Extra strong body
- » No need for concrete wall conduit
- » ABS plastic injection body
- » High UV and chemical resistant, unaffected by the sun



Üretim Yeri / Manufacturing Location
Türkiye'de Üretilmiştir / Made in Turkey
Marka / Brand
Neta Havuz Ürünü / Neta Pool Product

Elektropnömatik Kontrol Paneli Jet Stream Electropneumatic Panels



Öne Çıkan Özellikler Product Features

- » Regülasyon Amp. 4÷6,3
- » Plastik enjeksiyon gövde
- » CE onaylı şalt malzemesi
- » Beyaz renk plastik ABS pnomatik buton, pnomatik swich ve 3 mt boyunda pnomatik hortum fiyata dahildir
- » Regulation 4÷6,3
- » Plastic injection body
- » CE approved circuits
- » White plastic ABS pneumatic pushbutton, pneumatic swich and 3 mt long pneumatic hose are included in the price

KOD CODE	MODEL MODEL	FİYAT PRICE
12520112001	ATN063	345 €

Emiř Nozulu Jet Stream Inlet Nozzle

KIPSOL Marka / Brand
Dünya Markası / Global Brand



KOD CODE	HAVUZ TİPİ POOL TYPE	MODEL MODEL	FİYAT PRICE
12520113007	Beton Concrete	BAH.B	60 €
12520113008	Liner	BAL.B	120 €

Öne Çıkan Özellikler Product Features

- » ABS plastik enjeksiyon gövde
- » Yüksek UV ve kimyasal dayanımlıdır, güneřten etkilenmez
- » Sadece kit up jet ile alınması gereklidir
- » ABS plastic injection body
- » High UV and chemical resistant, unaffected by the sun
- » Only required to be taken with jet kit up

Kit Up Jet Set

KIPSOL Marka / Brand
Dünya Markası / Global Brand



Takıma Dahil Olanlar Sets Includes

- » Pompa
- » Masaj hortumu
- » Buton
- » Kumanda panosu
- » Pump
- » Massage hosel
- » Button
- » Control box

KOD CODE	HAVUZ TİPİ POOL TYPE	MODEL MODEL	FİYAT PRICE
12520113005	Beton Concrete	BCH.B	232 €
12520113006	Liner	BCL.B	253 €

Masaj Hortumu Jet Stream Massage Hose

KIPSOL Marka / Brand
Dünya Markası / Global Brand



Yüksek kimyasal dayanımı.
High UV and chemical resistant, unaffected by the sun.

KOD CODE	MODEL MODEL	FİYAT PRICE
12520113010	JS2.B	133 €



Tutamak Kolu Jet Stream Handle

Üretim Yeri / Manufacturing Location
Türkiye'de Üretilmiştir / Made in Turkey

Marka / Brand
Neta Havuz Ürünü / Neta Pool Product



AISI 304 paslanmaz çelik, tüm montaj elemanları ile birlikte.
AISI 304 stainless steel, with all mounting elements.

KOD CODE	MODEL MODEL	FİYAT PRICE
13017123001	W 051.TC	150 €

HAVUZ KENAR ÜRÜNLERİ POOL OUTDOOR PRODUCTS



HAVUZ KENAR EKİPMANLARI POOL OUTDOOR EQUIPMENT

Havuz kenarı için profesyonel çözümler.
Professional solutions for the poolside.

Güvenlik, erişilebilirlik ve dayanıklılık bir arada.
Security, accessibility and durability all in one.

Dayanıklı havuz kenar ekipmanlarıyla güvenlik ve işlevsellik artar. Neta Havuz, 30 yıllık tecrübesiyle firmalara uzun ömürlü, montajı kolay çözümler sunar.

With durable poolside equipment, safety and functionality increase. With 30 years of experience, Neta Havuz offers firms long-lasting and easy-to-install solutions.

Merdivenler & Basamaklar

Ladders & Steps

Üretim Yeri / Manufacturing Location

Türkiye'de Üretilmiştir / Made in Turkey

Marka / Brand

Neta Havuz Ürünü / Neta Pool Product



Öne Çıkan Özellikler Product Features

- » 1,2 mm et kalınlığı Ø42 mm boru çapı
- » Plastik enjeksiyon ankraj ve lastik takoz
- » Paslanmaz çelik rozet
- » Mükemmel polisajlı parlak yüzey kalitesi
- » 1.2 mm wall thickness Ø42 mm pipe diameter
- » Plastic injection anchor and rubber wedge
- » Stainless steel escutcheon plate
- » Bright surface quality with excellent polishing

140 mm çapında rozeti ile
With 140 mm diameter
escutcheon platefor

Su boşaltma kanallı
Including in water drain channel

Standart Seri Standart Serial

KOD CODE	BASAMAK SAYISI STEP NUMBER	MODEL	AISI	FİYAT PRICE
13015123001	2	DI 2	304	160 €
13015123002	3	DI 3	304	170 €
13015123003	4	DI 4	304	189 €
13015123004	5	DI 5	304	225 €
13015123034	2	ID 2	316	240 €
13015123027	3	ID 3	316	267 €
13015123028	4	ID 4	316	306 €
13015313028	5	ID 5	316	345 €



MODEL	Basamak Step	A mm	B mm	C mm	D mm	E mm	F mm	G mm
Standart	2	-	710	250	1.400	180	600	710
Standart	3	-	710	250	1.610	180	600	710
Standart	4	-	710	250	1.890	180	600	710
Standart	5	-	710	250	2.130	180	600	710

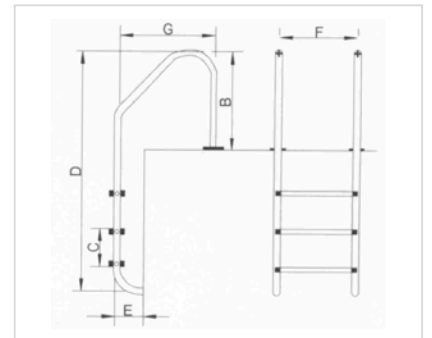

Muro Seri Muro Serial

Üretim Yeri / Manufacturing Location
Türkiye'de Üretilmiştir / Made in Turkey
Marka / Brand
Neta Havuz Ürünü / Neta Pool Product

KOD CODE	BASAMAK SAYISI STEP NUMBER	MODEL	AISI	FİYAT PRICE
13015123005	2	RI 2	304	160 €
13015123006	3	RI 3	304	170 €
13015123007	4	RI 4	304	189 €
13015123008	5	RI 5	304	225 €
13015123037	2	RI 2	316	240 €
13015123025	3	RI 3	316	267 €
13015123026	4	RI 4	316	306 €
13015123036	5	RI 5	316	345 €

MODEL	Basamak Step	A mm	B mm	C mm	D mm	E mm	F mm	G mm
Muro	2	400	720	250	1.360	180	600	-
Muro	3	420	720	250	1.610	180	600	-
Muro	4	420	720	250	1.860	180	600	-
Muro	5	420	720	250	2.120	180	600	-

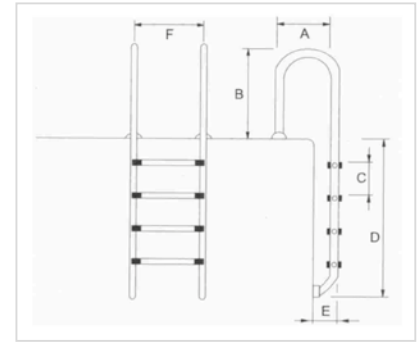

Mixta Seri Mixta Serial

KOD CODE	BASAMAK SAYISI STEP NUMBER	MODEL	AISI	FİYAT PRICE
13015123009	2	XI 2	304	165 €
13015123010	3	XI 3	304	179 €
13015123011	4	XI 4	304	199 €
13015123012	5	XI 5	304	249 €
13015123029	2	XI 2	316	267 €
13015123030	3	XI 3	316	306 €
13015123031	4	XI 4	316	355 €
13015123032	5	XI 5	316	385 €

MODEL	Basamak Step	A mm	B mm	C mm	D mm	E mm	F mm	G mm
Mixta	2	-	710	250	1.400	180	600	550
Mixta	3	-	710	250	1.610	180	600	620
Mixta	4	-	710	250	1.880	180	600	620
Mixta	5	-	710	250	2.120	180	600	620

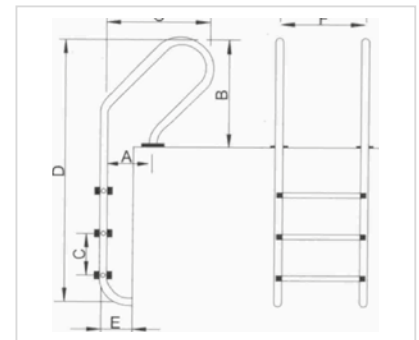

Münih Seri Munih Serial

Üretim Yeri / Manufacturing Location
Türkiye'de Üretilmiştir / Made in Turkey
Marka / Brand
Neta Havuz Ürünü / Neta Pool Product

KOD CODE	BASAMAK SAYISI STEP NUMBER	MODEL	AISI	FİYAT PRICE
13015123013	2	HI 2	304	249 €
13015123014	3	HI 3	304	269 €
13015123015	4	HI 4	304	310 €
13015123016	5	HI 5	304	330 €
13015123038	2	IH 2	316	275 €
13015123033	3	IH 3	316	315 €
13015123035	4	IH 4	316	365 €
13015123039	5	IH 5	316	385 €



MODEL	Basamak Step	A mm	B mm	C mm	D mm	E mm	F mm	G mm
Münih	2	1.390	680	250	710	842	180	500
Münih	3	1.650	720	250	960	842	180	600
Münih	4	1.890	680	250	1.210	842	180	500
Münih	5	2.140	680	250	1.460	842	180	500

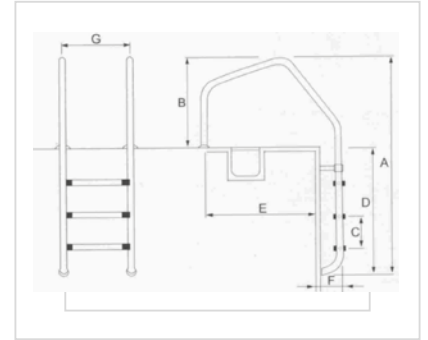

Two Part Seri Two Part Serial

KOD CODE	BASAMAK SAYISI STEP NUMBER	MODEL	AISI	FİYAT PRICE
13015123017	3	TW 3	304	340 €
13015123018	4	TW 4	304	360 €
13015123019	5	TW 5	304	405 €



Merdiven Anraji Paslanmaz Çelik Stainless Steel Anchor

KOD CODE	FİYAT PRICE
19813123001	20 €

- » AISI 304 paslanmaz çelikten üretilmiştir
- » Made of AISI 304 stainless steel
- » D 42 mm boru çapına montaja uygundur
- » It can be installed with D 42 mm pipe



Anot Pas Önleme Sistemi Pool Zing Anode

KOD CODE	ÇAP DIA	ÖLÇÜLER UxGxY SIZE LxWxH	FİYAT PRICE
199124001	63 mm	190x134x161	48 €



Merdiven Basamağı Ladder Step

Üretim Yeri / Manufacturing Location
Türkiye'de Üretilmiştir / Made in Turkey
Marka / Brand
Neta Havuz Ürünü / Neta Pool Product

Öne Çıkan Özellikler Product Features

- » AISI 304 ve 316 paslanmaz çelikten üretilmiştir
- » 1,2 mm et kalınlığında boru
- » Mükemmel polisajlı parlak yüzey
- » Paslanmaz malzeme bilgisi ve markanın logosu üzerindedir
- » Keskin köşesi yoktur
- » V tasarım ile ekstra dayanıklı basamaklar
- » Yeni tasarım lastik takoz
- » Basamak plastik yan parçaları paslanmaz çelik basamağa ilaveten paslanmaz çelik vidalarla monte edilmiştir

- » Made of AISI 304 and 316 stainless steel
- » 1,2 mm wall thickness
- » Excellent polished surface
- » Stainless steel quality marked and brandname is available
- » No sharp edge
- » Extra durable steps with V shape
- » New design elastic support
- » Side plastic piece installed to stair with stainless screw



KOD CODE	AISI	FİYAT PRICE
150123022	304	29 €
150123023	316	33 €

Eko Seri Merdivenler

Eco Series Ladder

Üretim Yeri / Manufacturing Location
Türkiye'de Üretilmiştir / Made in Turkey

Marka / Brand
Neta Havuz Ürünü / Neta Pool Product

KOD CODE	BASAMAK SAYISI STEP NUMBER	MODEL	AISI	FİYAT PRICE
13015313037	2	MURO	304	124.00 €
13015313038	3	MURO	304	141.00 €
13015313039	4	MURO	304	160.00 €
13015313040	5	MURO	304	180.40 €
13015123041	2	MIXTA	304	132.00 €
13015123042	3	MIXTA	304	150.00 €
13015123043	4	MIXTA	304	166.00 €
13015123044	5	MIXTA	304	185.00 €
13015313045	2	STANDART	304	132.45 €
13015313046	3	STANDART	304	149.00 €
13015313047	4	STANDART	304	180.00 €
13015313048	5	STANDART	304 </tr	

MURO

MODEL	A mm	B mm	C mm	D mm	E mm	F mm	G mm
MU-215	502	1.330	365	640	180	200	250
MU-315	502	1.580	365	640	180	200	250
MU-415	502	1.830	365	640	180	200	250
MU-515	502	2.080	365	640	180	200	250

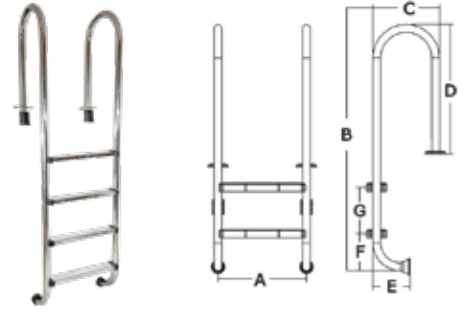

MIXTA

MODEL	A mm	B mm	C mm	D mm	E mm	F mm	G mm
MX2	502	1.330	650	640	180	200	250
MX3	502	1.580	650	640	180	200	250
MX4	502	1.830	650	640	180	200	250
MX5	502	2.080	650	640	180	200	250

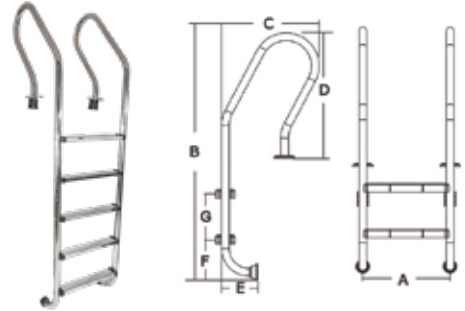

STANDART

MODEL	A mm	B mm	C mm	D mm	E mm	F mm	G mm
ST 2	502	1.330	650	640	180	200	250
ST 3	502	1.580	650	640	180	200	250
ST 4	502	1.830	650	640	180	200	250
ST 5	502	2.080	650	640	180	200	250

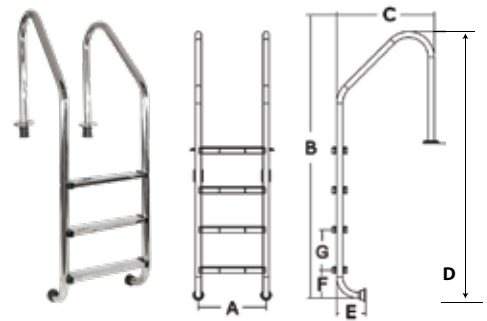

KOD CODE	TANIM DESCRIPTION	AISI	FİYAT PRICE
19822123005	Merdiven Ankrāj Bağlantısı Ladder Anchor Connection	304	20 €



Yer Üstü Merdivenler Ground Ladders

Paslanmaz Merdiven Stainless Steel Ladder

Öne Çıkan Özellikler Product Features

- » Yer üstü havuzlarda kullanıma uygun
- » 1,2 mm et kalınlığı Ø42 mm boru çapı
- » Mükemmel polisajlı parlak yüzey kalitesi
- » Suitable for use in above ground pools
- » 1.2 mm wall thickness Ø42 mm pipe diameter
- » Excellent polished surface finish



KOD CODE	BASAMAK SAYISI STEP NUMBER	MODEL	AISI	FİYAT PRICE
13015123020	2+2	Elevada	304	208 €
13015123021	3+3	Elevada	304	278 €
13015123022	4+4	Elevada	304	296 €

Platformlu Paslanmaz Merdiven Stainless Steel Ladder With Platform

Öne Çıkan Özellikler Product Features

- » Kaydırmaz yüzeyli platform
- » Yer üstü havuzlarda kullanıma uygun
- » 1,2 mm et kalınlığı Ø42 mm boru çapı
- » AISI 304 paslanmaz çelik rozet
- » Mükemmel polisajlı parlak yüzey kalitesi
- » Platform with non-slip surface
- » Suitable for use in above ground pools
- » 1.2 mm wall thickness Ø42 mm pipe diameter
- » AISI 304 stainless steel badge
- » Excellent polished surface finish



KOD CODE	BASAMAK SAYISI STEP NUMBER	MODEL	AISI	FİYAT PRICE
13015123023	3+3 Platformlu With Platform	Elevada	304	317 €
13015123024	4+4 Platformlu With Platform	Elevada	304	360 €

Paslanmaz Tutamak Stainless Handrails

Betonarme Basamaklar İçin For Reinforced Concrete Steps

Öne Çıkan Özellikler Product Features

- » 1,2 mm et kalınlığı Ø42 mm boru çapı
- » Montajı beton içine direkt olarak yapılır
- » 1.2 mm wall thickness Ø42 mm pipe diameter
- » Installation is made directly into concrete



KOD CODE	ÇAP DIAMETER	BOY LENGHT	AISI	FİYAT PRICE
13017123002	42 mm	1.300 mm	304	148 €

Tutamak Kolu Handrails

Öne Çıkan Özellikler Product Features

- » 1,2 mm et kalınlığı Ø42 mm boru çapı
- » AISI 304 paslanmaz çelik
- » Montajı civatalı flanş ile yapılır
- » Tüm civata ve montaj ekipmanları paketin içerisinde mevcuttur
- » 1.2 mm wall thickness Ø42 mm pipe diameter
- » AISI 304 stainless steel
- » Installation is done with bolted flange
- » All screws and assembly equipment are available within the package



KOD CODE	ÇAP DIAMETER	BOY LENGHT	MODEL	FİYAT PRICE
13017123001	42 mm	0,5 mt	051.TC.B	150 €
13017123003	42 mm	1 mt	101.TC	160 €
13017123004	42 mm	2 mt	201.TC	195 €
13017123005	42 mm	2,5 mt	251.TC	210 €

Duşlar Showers

Baston ve Tetra Serisi Duşlar Baston and Tetra Series Shower

Öne Çıkan Özellikler Product Features

- » Eysel ve ticari havuzlar için uygundur
- » AISI 304 paslanmaz çelikten üretilmiştir
- » Duş nozulu, duş gövdesi ve montaj elemanları ile birlikte
- » Suitable for villa type and commercial pools
- » Made of AISI 304 stainless steel
- » With shower nozzle, shower body and mounting elements



KOD CODE	ÜRÜN İSMİ PRODUCT NAME	ÖLÇÜ SIZE	BORU ÇAPI PIPE DIAMETER	FİYAT PRICE
13016113008	Baston Seri <i>Baston Serie</i>	AISI 304	Ø42	525 €
13016113009	Baston Seri Ayak Yıkamalı <i>Baston Series Foot Washer</i>	AISI 304	Ø42	575 €
13016113002	Tetra Seri Tekli <i>Tetra Serie Single</i>	AISI 304	Ø60	--
13016113003	Tetra Seri Tekli Ayak Yıkamalı <i>Tetra Series Single Foot Washer</i>	AISI 304	Ø60	--
13016113006	Tetra Seri Çift Başlık Kripsol <i>tetra Shower Double Kripsol</i>	AISI 304 120x60 mm	Ø60	350 €
13016113007	Tetra Seri Çiftli Ayak Yıkamalı Kripsol <i>Tetra Foot Wash Double Kripsol</i>	AISI 304 120x60 mm	Ø60	--
13016113010	Tetra Seri Yedek Ankrāj <i>Tetra Shower Anchor</i>	AISI 304	Ø60	55 €

Solar Duşlar Ayak Yıkamalı

Solar Shower With Foot Wash

Öne Çıkan Özellikler Product Features

- » Solar duş seti, 20 ve 35 litrelik su haznesi ve dış mekâna uygun siyah-gümüş tasarımıyla verimli bir çözüm sunar
 - » Büyük yağmur başlığı ideal yükseklikte konumlandırılmıştır
 - » Kademesiz sıcaklık ayarı rahat sıcaklık kontrolü sağlar
 - » Tek kollu musluk ve ayak yıkama musluğu kolay kullanım sunar
 - » 2 yıl garantilidir
- » The solar shower set offers an efficient solution with a 20 and 35-liter water tank and outdoor-friendly black-silver design
 - » Large rain head positioned at optimal height
 - » Stepless temperature control for easy adjustment
 - » Single-lever faucet and foot-wash faucet for convenient use
 - » 2 years warranty



Model: SOS3511



Model: SOS2011



Suni Ahşap Taban

Wooden Base



KOD CODE	ÖLÇÜ SIZE	FİYAT PRICE
GAR202310024	64x100 cm	130 €

KOD CODE	TANK KAPASİTESİ TANK CAPACITY	ÖLÇÜ SIZE	TANK CİNSİ TANK MATERIAL	BASINÇ MAX PRESSURE	FİYAT PRICE
GAR2023100082	20 LT	2160xdiax110mm	PVC	4.0 BAR	300 €
GAR2023100081	35 LT	2170x220x180mm	PVC	4.0 BAR	350 €

Engelli Havuz Asansörü Disabled Pool Lift

Üretim Yeri / Manufacturing Location
Türkiye'de Üretilmiştir / Made in Turkey

Öne Çıkan Özellikler Product Features

- » Fiziksel kısıtlamaları olan bireylere özel
 - » El kumanda sistemli
 - » Acil stop butonu
 - » Akü şarj göstergesi
 - » Fren mekanizması
 - » Ayak ve kol desteği
 - » Emniyet kemeri
 - » 150 kg taşıma kapasitesi
- » For projects which require a pool lift for individuals with limitations
 - » Manual control system
 - » Emergency stop button
 - » Battery charge indicator
 - » Brake mechanism
 - » Foot and arm support
 - » Safety belt
 - » Capacity 150 kg

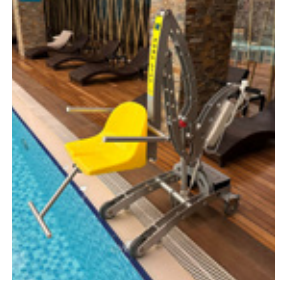
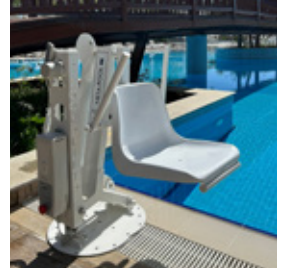

KOD CODE	MODEL	HIZ MAX. VELOCITY MAX.	YÜKLÜ SUYA İNDİRME SÜRESİ LAUNCH TIME WITH LOAD	YÜKLÜ KALDIRMA SÜRESİ LOAD TIME	FİYAT PRICE
POLLIFT001	Pool Lift Sabit <i>Fixed</i>	0,07 m/sn.	max. 25 sn.	max. 30 sn.	5.090 €
POLLIFT002	Pool Lift Mobil <i>Mobile</i>	0,07 m/sn.	max. 25 sn.	max. 30 sn.	6.220 €



Üretim Yeri / Manufacturing Location
Türkiye'de Üretilmiştir / Made in Turkey

Marka / Brand
Neta Havuz Ürünü / Neta Pool Product

Kaydırak Slides

Öne Çıkan Özellikler Product Features

- » Cam elyaf takviyeli polysterden üretilmiştir
 - » Polyester basamaklı
 - » AISI 304 paslanmaz çelik tutunma kolları
 - » Paslanmaz çelikten mamul destek kaidesi ekipmanları ile birlikte
 - » Sağa kıvrımlı
- » Made of glass fiber reinforced polyester
 - » Polyester steps
 - » AISI 304 stainless steel grab handles
 - » With support base equipment made of stainless steel
 - » Right curved

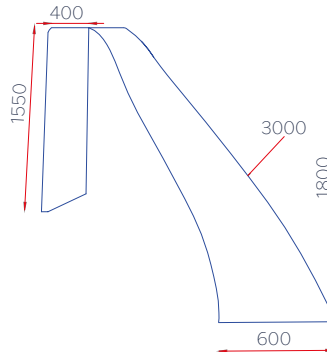

KOD CODE	MODEL	AĞIRLIK WEIGHT	HACİM VOLUME	FİYAT PRICE
13018122004	TB 2000.B	54 kg	0,400 m ³	1.890 €

Tramplen Diving Board

Öne Çıkan Özellikler Product Features

- » Cam elyaf takviyeli polyeşterden üretilmiştir
- » Kaydırmaz üst yüzey
- » Uv ısınlrına dayanıklı
- » Made of glass fiber reinforced polyester
- » Non-slip surface
- » UV resistant



KOD CODE	MODEL	UZUNLUK LENGHT	GENİŞLİK WIDTH	FİYAT PRICE
13018122001	WFT 200.B	2 mt	42 cm	490 €



Taşma Izgaraları Overflow Gratings

Öne Çıkan Özellikler Product Features

- » Polipropilen'den üretilmiştir
- » Kaydırmaz üst yüzeye sahip
- » Uv ışınlarına dayanımlı
- » Modüler tek geçme ve çift geçme özelliği
- » Izgara yüksekliği: 2,5 mm
- » I profil
- » Made of polypropylene
- » Non-slip surface
- » UV resistant
- » Modular single plug and double plug feature
- » Height of gratings: 2,5 mm
- » I profile

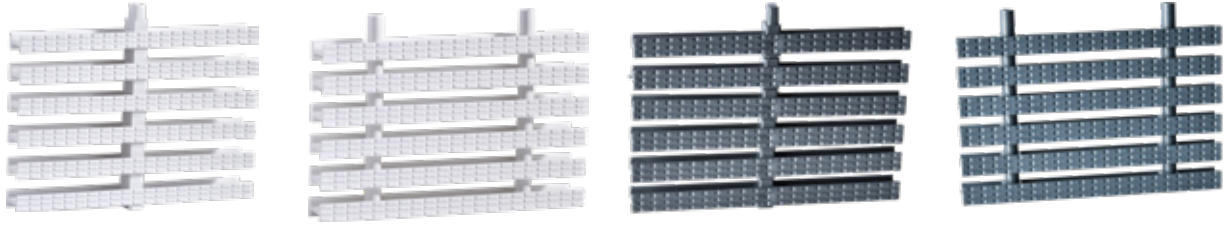

KOD CODE	MODEL	FİYAT PRICE
13019002001	15 cm tek geçme-klasik desen 15 cm Single spine classic pattern	8.00 €
13019121002	20 cm tek geçme-tek desen lüks seri profil 20 cm single spine classic pattern	8.80 €
13019121011	20 cm çift geçme-tek desen lux seri wf 20 cm double spine classic pattern lux wf	9.80 €
13019121026	25 cm tek geçme-tek desen lux seri wf 25 cm single spine classic pattern lux wf	10.50 €
13019121027	25 cm çift geçme-tek desen lux seri wf 25 cm double spine classic pattern lux wf	11.50 €
13019002006	30 cm çift geçme-klasik desen 30 cm double spine classic pattern	16.00 €

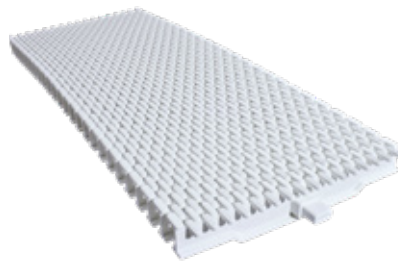

KOD CODE	MODEL	FİYAT PRICE
13019121033	20 cm tek geçme grift desen I profil Overflow grating grift single link 20 cm	13.80 €
13019121008	25 cm tek geçme grift desen I profil Overflow grating grift single link 25 cm	15.90 €
13019121009	30 cm tek geçme grift desen I profil Overflow grating grift single link 30 cm	21.00 €

Izgara Köşe Parçaları Grating Corner Parts

Öne Çıkan Özellikler Product Features

- » Polipropilen'den üretilmiştir
- » Kaydırmaz üst yüzey
- » UV ışınlarına dayanımlı
- » 90 ve 45 derecelik açılarda
- » Made of polypropylene
- » Non-slip surface
- » UV resistant
- » 90 and 45 degree angles



KOD CODE	MODEL	FİYAT PRICE
13019121028	15cm-45° köşe parçası 15cm-45° Corner Piece	7.00 €
13019002014	15cm-90° köşe parçası 15cm-90° Corner Piece	7.00 €
13019002011	20cm-45° köşe parçası 20cm-45° Corner Piece	8.00 €
13019121001	20cm-90° köşe parçası 20cm-90° Corner Piece	8.00 €
13019002012	25cm-45° köşe parçası 25cm-45° Corner Piece	9.00 €
13019121010	25cm-90° köşe parçası 25cm-90° Corner Piece	9.00 €
13019002013	30cm-45° köşe parçası 30cm-45° Corner Piece	19.50 €
13019002017	30cm-90° köşe parçası 30cm-90° Corner Piece	10.00 €

Izgara Kenar Profili Grating Edge Profile

Öne Çıkan Özellikler Product Features

- » PVC'den üretilmiştir
- » Taşma ızgaralarının kolayca kanala yerleşmesini sağlar
- » Made of PVC
- » Allows overflow grids to be easily placed in the channel



KOD CODE	KENAR ÖLÇÜLERİ EDGE SIZE	BOY LENGHT	FİYAT PRICE
13019121018	16x10 mm	2000 mm	1.50 €

Savak Gideri Gutter Drain



KOD CODE	ÇAP DIA	FİYAT PRICE
13020123001	16x10 mm	6 €

Öne Çıkan Özellikler *Product Features*

- » ABS plastik enjeksiyondan üretilmiştir
- » Taşma kanallarının toplama hattında kullanılır
- » Güçlü ve sağlam gövde yapısına sahiptir
- » UV dayanımlıdır, güneşten etkilenmez
- » Produced from ABS plastic injection
- » Used in the collection line of overflow channels
- » Strong and robust body structure
- » UV resistance

Savak Gideri Kapağı Gutter Drain Cover



KOD CODE	ÖLÇÜ SIZE	FİYAT PRICE
12518121003	100x200 mm	9.52 €

Öne Çıkan Özellikler *Product Features*

- » ABS plastik enjeksiyondan üretilmiştir
- » Taşma kanallarının toplama hattında kullanılır
- » Güçlü ve sağlam gövde yapısına sahiptir
- » UV dayanımlıdır, güneşten etkilenmez
- » 50, 63, 90 mm çaplarında kullanılabilir
- » Produced from ABS plastic injection
- » Used in the collection line of overflow channels
- » Strong and robust body structure
- » UV resistance
- » Can be used in diameters of 50, 63, 90 mm

Tařma Gideri Süzgeci Paslanmaz Çelik Overflow Drainer Stainless Steel

Öne Çıkan Özellikler *Product Features*

- » AISI 304 paslanmaz çelik
- » AISI 304 stainless steel
- » Tařma kanallarının toplama hattında kullanılır
- » Used in the collection line of overflow channels



KOD CODE	ÇAP DIA	FİYAT PRICE
13020122001	63 mm	24 €
13020122002	75 mm	25 €
13020122003	90 mm	27 €
13020122004	110 mm	28 €

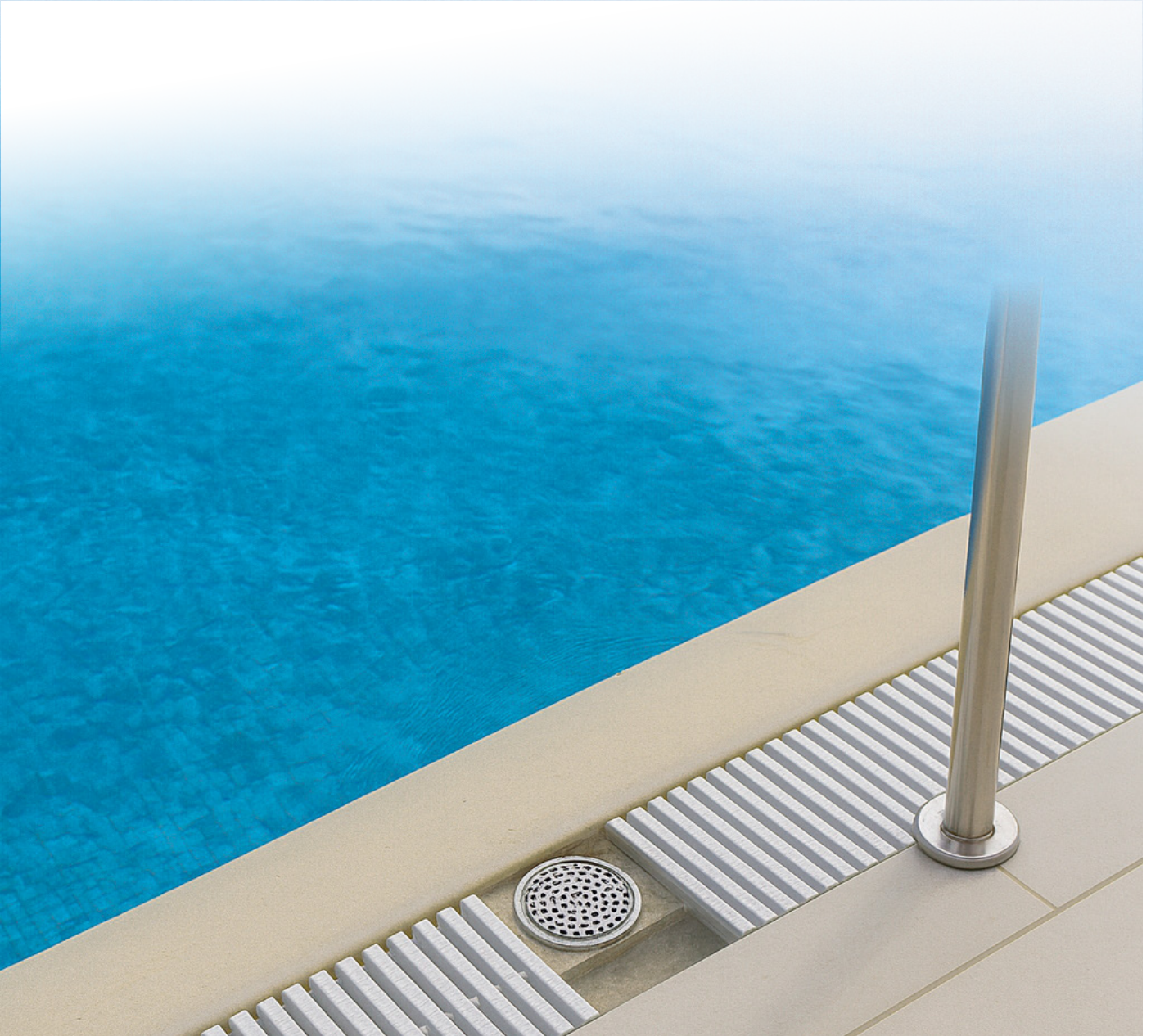

HAVUZ TEMİZLİK ÜRÜNLERİ POOL CLEANING PRODUCTS



HAVUZ TEMİZLİK EKİPMANLARI POOL CLEANING EQUIPMENT

Havuz projelerinde temizlik ve bakım ekipmanları.
Cleaning and maintenance equipment in pool projects.

Havuz Hijyeninde Profesyonel Standartlar.
Professional Standards in Pool Hygiene.

Neta Havuz, vakum süpürgelerden robotlara kadar geniş ürün yelpazesıyla profesyonel firmalara dayanıklı ve kullanımı kolay çözümler sunar.

With a wide range from vacuum cleaners to robots, Neta Havuz provides durable and easy-to-use solutions for professionals.

Vakum Süpürgeler & Yedek Parçaları

Vacuum Cleaners & Spare Parts

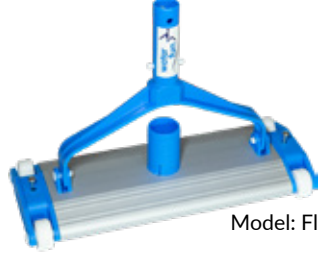

Model: Flat 38.C

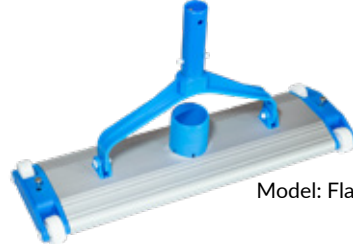

Model: Flat 50.C

Öne Çıkan Özellikler Product Features

- » Havuz dibine çöken pisliklerin temizlenmesini sağlar
- » Betonarme havuzlar için uygundur
- » Alüminyum süpürge gövdelidir
- » Havuz hortumu, bağlantı koniği ve sapı ile beraber kullanılır
- » Kullanıcıyı yormayacak ve havuz dibine batabilen optimum ağırlığa sahiptir
- » Provides cleaning of the dirt that settles on the bottom of the pool
- » Suitable for reinforced concrete pools
- » It has an aluminum broom body
- » Used with pool hose, union fittings and handle
- » It has the optimum weight that does not tire the user and can sink to the bottom of the pool

KOD CODE	MODEL	GENİŞLİK WIDTH	BAĞLANTI Ø CONNECTION Ø	FİYAT PRICE
14015123001	Flat 38.C	36	1 ½"	29 €
14015123002	Flat 50.C	46	1 ½"	32 €
14015123003	Flat 50.C	46	2"	39 €

Plastik Çatal Plastic Fork



19815122001	1 ½"	10 €
19815122002	2"	11 €

Bağlantı Koniği Connection Union



19815123002	6 €
19815123003	7 €

Fırça Brush



19815123007	10 €
19815123008	13 €

Süpürge Tekerlek Gövdesi Side Body For Wheel



19815123001	8 €
-------------	-----

Süpürge Çatalı Bağlantısı Fork Connection



19815123004	3 €
-------------	-----

Tekerlek Wheel



19815123005	3 €
-------------	-----

Süpürge Tekerlek Pimi Broom Wheel Pim



19815123006	2 €
-------------	-----

Conta Seal



19815123009	9 €
-------------	-----

Süpürge Çatal Pimi Broom Fork Pim



19815123010	2 €
-------------	-----

Liner Havuzlar İçin Süpürgeler

Pool Cleaners For Liner Pools

Öne Çıkan Özellikler Product Features

- » Eysel ve ticari havuzlar için uygundur
- » AISI 304 paslanmaz çelikten üretilmiştir
- » Duş nozulu, duş gövdesi ve montaj elemanları ile birlikte
- » Suitable for villa type and commercial pools
- » Made of AISI 304 stainless steel
- » With shower nozzle, shower body and mounting elements

Ekonomik Liner Süpürge Economic Liner Cleaner Head



KOD CODE	MODEL	BAĞLANTI Ø CONNECTION Ø	FİYAT PRICE
14015123006	WF 82S	1 ½"	18 €

Lüks Liner Süpürge Deluxe Liner Cleaner Head



KOD CODE	MODEL	BAĞLANTI Ø CONNECTION Ø	FİYAT PRICE
14015123007	WF 32S	1 ½"	18 €



Üçgen şekli sayesinde köşeleri kolayca temizler, tampon çevresi havuz kaplamasını korur
Triangular shape easily cleans corners, bumper perimeter protects pool liner

KOD CODE	MODEL	BAĞLANTI Ø CONNECTION Ø	FİYAT PRICE
14015123008	WF 25S	1 ½"	18 €

Teleskopik Süpürge Sapı Telescopic Cleaner Poles



KOD CODE	UZUNLUK LENGTH	FİYAT PRICE
14017123001	2x2.4 4,80 mt	34 €
14017123004	2x3 6 mt	36 €
14017123003	3x3 9 mt	59 €
14017123010	2x1,8 3,6 mt	32 €

Öne Çıkan Özellikler Product Features

- » Alüminyumdan üretilmiştir
- » Bağlantı rakorları sayesinde istenilen uzunlukta ayarlanabilir
- » Mukavemeti yüksektir, süpürme veya fırçalama esnasında eğrilmez
- » Yumuşak tutamağı elinizi acıtmaz
- » Made of aluminum
- » Thanks to the connection fittings, it can be adjusted to the desired length
- » High strength bar does not bend during sweeping or brushing
- » Soft handle doesn't hurt your hand

Süpürge Hortumu Hose Rools

Öne Çıkan Özellikler Product Features

- » Yüksek kaliteli, UV'ye dayanıklı polietilenden üretilmiştir
- » Hafiftir su üzerinde yüzer ve batmaz
- » Esnek olması sayesinde süpürme esnasında rahat hareket edebilmenizi sağlar
- » Uzun ömürlüdür
- » Made of high-quality, UV resistant polyethylene
- » It is light, floating on water and does not sink
- » It is flexible, allowing you to move comfortably while sweeping
- » Long lasting



IPSOL

Marka / Brand
Dünya Markası / Global Brand

KOD CODE	ÜRÜN ADI PRODUCT	HORTUM ÇAP HOSE DIA	UZUNLUK LENGTH	FİYAT PRICE
14018113001	Roma Model	38 mm - 1/2"	30 mt	3.89 €
14018113002	Roma Model	50 mm - 2"	30 mt	4.70 €



Üretim Yeri / Manufacturing Location

Türkiye'de Üretilmiştir / Made in Turkey

Marka / Brand

Neta Havuz Ürünü / Neta Pool Product

KOD CODE	HORTUM ÇAPI HOSE DIA	UZUNLUK LENGTH	FİYAT PRICE
14018123002	38 mm - ½"	10,5 mt	30 €
14018123001	38 mm - ½"	30 mt	82.2 €

Süpürge hortumu koniği ile birlikte teslim edilir.
It is delivered with the union fittings.



Süpürge Hortum Koniği Vacuum Hose Cone



KOD CODE	MODEL	FİYAT PRICE
19815122003	50-63 Dişli 50-63 Threaded	3 €

Öne Çıkan Özellikler Product Features

- » 38 mm ve 50 mm hortum için uygundur
- » İçten dişli oluşu sayesinde vakum esnasında hortumdan çıkmaz
- » Suitable for 38 mm and 50 mm hose
- » Thanks to its female threaded, it does not come out of the hose during vacuum



KOD CODE	MODEL	FİYAT PRICE
19815123011	50-63 Dişli 50-63 Threaded	1,5 €

Öne Çıkan Özellikler Product Features

- » 38 mm ve 50 mm hortum için uygundur
- » Dıştan dişli monte edilir
- » Suitable for 38 mm and 50 mm hose
- » Mounted as male threaded

Portatif Vakum Süpürgeleri

Portable Vacuum Cleaners

Öne Çıkan Özellikler Product Features

- » Vakum hattı olmayan havuzlar ve göletlerde kullanım için uygundur
- » Üzerine monte edildiği el arabası sayesinde kolay hareket ettirilebilir ve havuzun tüm bölgelerinin temizlenmesi sağlanır
- » Talebe göre portatif bir filtrasyon ünitesi oluşturulur
- » Suitable for using in pools and ponds which haven't a vacuum line
- » Thanks to the wheelbarrow on which it is mounted, it can be moved easily and all parts of the pool are cleaned
- » A portable filtration unit is optional

Takıma Dahil Olanlar Sets Includes

- » Kartuş filtre / Kum filtresi
- » Sirkülasyon pompası (0,75 HP)
- » Vakum süpürgesi
- » Hortum
- » Teleskopik sap
- » Tekerlekli araba
- » Sigorta ve 15 mt kablo
- » Cartridge filter / Sand filter
- » Circulation pump (0,75 HP)
- » Vacuum cleaner
- » Hose
- » Telescopic pole
- » Wheeled car
- » Fuse and 15 mt cable



Kartuş Filtreli Sistem Cartridge Filter System

KOD CODE	FİLTRE FILTER	FİLTASYON DEBİSİ FILTRATION FLOW	POMPA PUMP	POMPA DEBİSİ PUMP FLOW	FİYAT PRICE
14015122004	Kartuş Filtre KF 100 Cartridge Filter KF 100	22,9 m³/h	Senkron 0,75 Hp	17,8 m³/h	1.199 €



Kum Filtreli Sistem Sand Filter System

KOD CODE	FİLTRE FILTER	FİLTASYON DEBİSİ FILTRATION FLOW	POMPA PUMP	POMPA DEBİSİ PUMP FLOW	FİYAT PRICE
14015122006	Rotex 600 mm	12 m³/h	Senkron 0,75 Hp	17,8 m³/h	1.465 €



Goodrob Havuz Temizleyici Serisi

Goodrob Pool Cleaning Series



NEDEN GOODROB HAVUZ ROBOTLARI? WHY CHOOSE GOODROB ROBOT?

Kablosuz Kullanım
Wireless Use

Mutlu Müşteri
Happy Customer

Uzun Çalışma Süresi
Long Working Time

*Goodrob ile müşterilerinize daha hızlı, zahmetsiz ve kusursuz temizlik sunun.
Deliver faster, effortless, and flawless cleaning to your clients with Goodrob.*



Goodrob Easy

PRATİK TEMİZLİK EASY CLEANING

Her havuzlu evde olması gereken bir süpürge olan Goodrob Easy, yalnızca havuz tabanını temizlemek için tasarlanmış kablosuz bir çözümdür.

Goodrob Easy, the must-have cleaner for every home with a pool, is a cordless solution designed solely for floor cleaning.

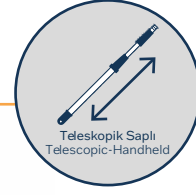

Öne Çıkan Özellikler Product Features

- » Betonarme, liner, polyester, spa havuzlarında kullanılır
- » Kablosuz tasarım
- » Hızlı şarj, uzun çalışma süresi
- » 60,5 lt/dk güçlü emiş özelliği
- » Teleskopik sap uzunluğu 2,4 metre
- » Giriş: 1 inç
- » Köşeleri temizlemek için çok amaçlı vakum başlığı
- » Duvar ya da basamakları iyi temizler
- » Kum, talaş, böcek, küçük yaprakları süpürür

- » Can be used in reinforced concrete, liner, polyester, Spa pools
- » Cordless design
- » Fast charging, long running time
- » Powerful suction 60,5 lt / mins
- » Telescopic pole length 2,4 m
- » Inlet size 1"
- » For corners multi-purpose triangular vacuum head
- » Replaceable cleaning head, perfect for pool steps and hard-to-clean walls&corners
- » Vacuums leaves, small twigs, bugs, debris, dirt, sand & algae

Takıma Dahil Olanlar:

- 1*süpürge,
- 2* filtre torbası (100/300 fileli),
- 1* teleskopik sap (0.7-2.4m),
- 1* şarj aleti (21V-1.5A)

Set Includes

- 1* cleaner,
- 2* filter bags (100/300 mesh),
- 1* telescopic pole (0.7-2.4m),
- 1* charger (21V-1.5A)



Çok Amaçlı Üçgen Vakum Başlığı

Üçgen vakum başlığı ile dibi en ince ayrıntısına kadar temizler.

Multi-purpose Triangular Vacuum Head

It cleans the bottom in every detail with its triangular vacuum head.



Kullanım kılavuzuna ulaşmak için QR kodu okutun.

Scan the QR code to access the user manual.



Kutu açılışını izlemek için QR kodu okutun.

Scan the QR code to watch the unboxing.



Kullanıcı yorumunu izlemek için QR kodu okutun.

Scan the QR code to view user comments.



KOD CODE	SAP UZUNLUĞU POLE LENGHT	GÜÇ POWER INPUT	AĞIRLIK WEIGHT	FİYAT PRICE
19815273202	0,7 - 2,4 mt	100-240 V 50/60 HZ	3,5 kg	299 €

Goodrob Easy Plus

GÜÇLÜ SEÇENEK POWERFUL CHOICE

Goodrob Easy Plus, havuz tabanını temizlemek için tasarlanmış kablosuz bir süpürge. Geniş başlığı ve büyük haznesiyle pratik ve güçlü bir çözümdür.

Goodrob Easy Plus is a cordless vacuum designed for pool floor cleaning. With its wide head and large capacity, it is a practical and powerful solution.



60 DK ÇALIŞMA SÜRESİ
60 MINS. WORKING TIME

1,8 LT HAZNE KAPASİTESİ
MAIN HOUSING
CAPACITY 1,8 LT

1,5 SAAT ŞARJ OLUR
1,5 CHARGING TIME

GÜÇ GÖSTERGE IŞIĞI
POWER INDICATOR LIGHT

IP X8

DAHA BÜYÜK BAŞLIK
HUGE VACUUM HEAD

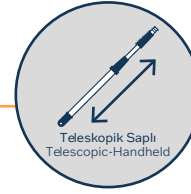

Öne Çıkan Özellikler Product Features

- » Betonarme, liner, polyester, spa havuzlarında kullanılır
- » Kablosuz tasarım
- » Hızlı şarj, uzun çalışma süresi
- » LED ışık sistemi, cihazın güç seviyesini yeşil ve kırmızı ışıklarla göstererek düşük şarj durumunda kullanıcıyı uyarır
- » Optimize edilebilir fırça konumu ve daha büyük vakum başlığı
- » Bakır Sargı: Ürün, bakır sargılı motor ile dayanıklılık sağlar.
- » Nominal Güç: 40W - Nominal Voltaj: DC 18V
- » Pil Kapasitesi: 2AH
- » Kullanım Süresi: Tam şarj ile 50-60 dakika
- » Şarj Süresi: 90 dakika
- » Şarj Cihazı Kablo Uzunluğu: 1,2 m
- » Çıkış: 21V-1,5A
- » Maksimum Parçacık Geçiş: <25 mm
- » Giriş Boyutu: 1"
- » Maksimum Basma Yüksekliği: 2,5 - 3 m
- » Maksimum Akış Hızı: 4200 l/h

- » Suitable for concrete, liner, polyester, and spa pools
- » Cordless design
- » Fast charging, long working time
- » LED light system indicates the device's power level with green and red lights, alerting the user when the charge is low
- » Optimizable brush position and larger vacuum head
- » Copper Wire: The product ensures durability with a copper-wound motor
- » Rated Power: 40W - Rated Voltage: DC 18V
- » Battery Capacity: 2AH
- » Usage Time: 50-60 minutes on a full charge
- » Charging Time: 90 minutes
- » Charger Cable Length: 1.2 m
- » Output: 21V-1.5A
- » Maximum Passage Particles: <25 mm
- » Inlet Size: 1"
- » Maximum head is between 2.5 - 3 m
- » Maximum Flow Rate: 4200 l/h

Takıma Dahil Olanlar:

- 1*süpürge,
- 2*filtre torbası (100/300 fileli),
- 1* teleskopik sap (0.7-2.4m),
- 1*şarj aleti (21V-1.5A)

Set Includes

- 1*cleaner,
- 2*filter bags (100/300 mesh),
- 1* telescopic pole (0.7-2.4m),
- 1*charger(21V-1.5A)



Kullanım kılavuzuna ulaşmak için QR kodu okutun.

Scan the QR code to access the user manual.



Geniş emiş portu Suction port is enlarged



Optimize edilmiş fırça tasarımı Optimized brush design



KOD CODE	SAP UZUNLUĞU POLE LENGTH	GÜÇ POWER INPUT	AĞIRLIK WEIGHT	FİYAT PRICE
19815273203	0,7 - 2,4 mt	100-240 V 50/60 HZ	3 kg	339 €

Goodrob Maxi



TABAN UZMANI FLOOR EXPERT

Yalnızca havuz tabanını temizlemek için tasarlanmış kablosuz bir robottur. Uzun çalışma süresi ve güçlü emişle profesyonellerin güvenilir yardımcısıdır.

A cordless robot designed exclusively for pool floor cleaning. With long runtime and strong suction, it is a reliable assistant for professionals.



Öne Çıkan Özellikler Product Features

Tasarım ve Kullanım

- » Kablosuz tasarım
- » Betonarme, liner ve fiberglass havuzlarda kullanılabilir
- » Yer üstü ve yer altı havuzlar için uygundur

Performans ve Çalışma

- » 100 dakika çalışma süresi
- » 80 m²'ye kadar havuzlarda etkili temizlik
- » Sadece havuz zeminini süpürür
- » Akıllı navigasyon teknolojisiyle duvarla karşılaşıncaya otomatik geri döner

Filtrasyon

- » 180 mikron filtre yoğunluğu
- » Yedek 100 mikron filtre dahildir

Kullanım Kolaylığı

- » Pili azaldığında havuz kenarına yanaşarak kolayca alınır
- » Hafif, taşınması ve kullanması çok kolay
- » Pil azaldığında duvara yaklaşarak kolay çıkarma imkânı sunar

Design & Compatibility

- » Cordless design
- » Suitable for reinforced concrete, liner, and fiberglass pools
- » Ideal for both above-ground and in-ground pools

Performance

- » 100 minutes of runtime
- » Effective cleaning for pools up to 80 m²
- » Cleans only the pool floor
- » Smart navigation automatically reverses when it hits a wall

Filtration

- » 180-micron filtration density
- » There is an extra filter 100µm provided as spare parts

Ease of Use

- » Parks at the pool wall when battery is low for easy removal
- » Lightweight, easy to carry and operate
- » It can as well go to pool wall as battery runs out for easy taking out of water

Basit Yapı

Basit tasarımı sayesinde bakım ve temizlik işlemleri hızlı ve zahmetsizdir.

Simple Structure

Its simple design allows for quick and effortless maintenance and cleaning.



Akıllı Sensör

Bir engel ile karşılaşırsa ters yöne doğru gider.

Smart Sensor

If it encounters an obstacle, it reverses direction.



Kullanım kılavuzuna ulaşmak için QR kodu okutun.

Scan the QR code to access the user manual.



Performans videosu için QR kodu okutun.

Scan the QR code to watch performance video.



KOD CODE	ŞARJ SÜRESİ CHARGING TIME	GÜÇ POWER	AĞIRLIK WEIGHT	FİYAT PRICE
19815273200	4 Saat Hour	30W	3,9 kg	490 €

Goodrob Pro



AKILLI YÖN SMART PATH

Akıllı yol planlama ve güçlü emişiyle taban, duvar ve su hattında etkili temizlik sağlar.

With intelligent path planning and strong suction, it cleans floors, walls, and the waterline effectively.



KABLOSUZ
CORDLESS



110 DK ÇALIŞMA SÜRESİ
110 MINS. WORKING TIME



DUVARA TIRMANIR
CLIMB THE WALL



4 SAAT ŞARJ OLUR
4 CHARGING TIME



IP X8



CE

Öne Çıkan Özellikler Product Features

Tasarım ve Kullanım

- » Kablosuz tasarım
- » Betonarme, liner ve fiberglass havuzlarda kullanılabilir
- » Yer üstü ve yer altı havuzlar için uygundur

Performans ve Çalışma

- » 4 saatte tam şarj, 110 dakika kesintisiz çalışma
- » 120 m²'ye kadar havuz temizliği
- » Havuz zeminini ve duvarını güçlü emiş gücüyle temizler
- » Akıllı yol planlama ve tarama algoritmasıyla koordinat belirler

Filtrasyon

- » 4,5 litre filtre kapasitesi
- » 180 mikron filtre yoğunluğu
- » Gizli tozu, kir, tortu ve yosunları etkili şekilde temizler

Kullanım Kolaylığı

- » Şarj bitmeden önce havuz duvarına yanaşarak park eder, kolayca sudan alınır

Design & Compatibility

- » Cordless design
- » Suitable for reinforced concrete, liner, and fiberglass pools
- » Ideal for both above-ground and in-ground pools

Performance

- » Fully charges in 4 hours, operates for 110 minutes
- » Cleans pools up to 120 m²
- » Effectively cleans pool floor and walls with strong suction power
- » Smart path planning and scanning algorithm for efficient coverage

Filtration

- » 4,5-liter filter capacity
- » 180-micron filtration density
- » Captures fine dust, dirt, debris, and algae effectively

Ease of Use

- » Automatically parks at the pool wall before battery runs out for easy removal

1 Geniş Emiş Kapısı

Geniş emiş kapısı sayesinde yaprak, kum ve iri kirleri kolayca toplar.

1 Wide Suction Door

The wide suction port easily collects leaves, sand, and larger debris.

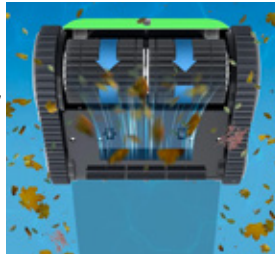

Performans videosu için QR kodu okutun.

Scan the QR code to watch performance video.



Kullanım kılavuzuna ulaşmak için QR kodu okutun.

Scan the QR code to access the user manual.



KOD CODE	ŞARJ SÜRESİ CHARGING TIME	GÜÇ POWER	AĞIRLIK WEIGHT	FİYAT PRICE
1981527320	4 Saat Hour	65W	7,7 kg	1.280 €

KRAL TACINI TAKMAYA GELİYOR!

THE KING IS TAKING THE CROWN!



Süper hızlı temizleme hızı
Superfast cleaning speed



8 Saat Çalışma Süresi
8 Hours of runtime



Modüler tasarım
Modular design

8Hr

8 Saat
Çalışma
Süresi

of Run Time

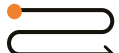

Akıllı
Yol Planlama
Intelligent Path
Planning

1+N

Farklı
Aksesuarlar
Magnetic
Accessories



6Lt

6 Litre
Büyük Çift
Filtre

Dual Large Filters



Telefonla
Kontrol
Smart APP



Goodrob King 500



ÜSTÜN PERFORMANS SUPERIOR PERFORMANCE

Taban, duvar ve su çizgisi temizliği yapan kablolu bir robottur. Uzun çalışma süresi ve uzaktan kumanda veya mobil uygulama ile kolay kontrol özelliğiyle profesyoneller için güçlü bir çözümdür.

Cordless robot for cleaning floors, walls, and the waterline. Its long runtime and easy control via remote or mobile app make it a powerful solution for professionals.



Öne Çıkan Özellikler Product Features

Tasarım ve Kullanım

- » Kablosuz tasarım
- » Betonarme, liner, polyester ve spa havuzlarında kullanım
- » Yer üstü ve yer altı havuzlar için uygundur

Performans ve Çalışma

- » 6 saate kadar çalışma süresi
- » 18.000 mAh batarya kapasitesi
- » 100W güçlü motor (60W opsiyonel hızlı şarj)
- » 0,5 m/s temizlik hızı
- » AdaptiveNav 3.0 akıllı yol planlama
- » 3 farklı çalışma seçeneği: taban, duvar, taban + duvar
- » Günlük ve haftalık olmak üzere 2 temizlik modu
- » Yüzey, duvar, su çizgisi ve köşe temizliği

Filtrasyon

- » 25 mikrona kadar filtreleme

Kullanım Kolaylığı

- » Otomatik park etme ve self-rescue özelliği
- » Uzaktan kumanda ve mobil uygulama ile kontrol

Design & Compatibility

- » Cordless design
- » Suitable for reinforced concrete, liner, polyester, and spa pools
- » Ideal for both above-ground and in-ground pools

Performance

- » Up to 6 hours of runtime
- » 18,000 mAh battery capacity
- » Powerful 100W motor (optional 60W fast charging)
- » 0.5 m/s cleaning speed
- » AdaptiveNav 3.0 smart path planning
- » 3 cleaning modes: floor, wall, floor + wall
- » 2 cleaning programs: daily and weekly
- » Cleans surface, walls, waterline, and corners

Filtration

- » Filtration up to 25 microns

Ease of Use

- » Automatic parking and self-rescue feature
- » Remote control & mobile app operation

1+N çok fonksiyonlu tasarım

Farklı aksesuarlarla uyumlu yapısı sayesinde tek cihazla çok fonksiyonlu kullanım sağlar.

1+N multi-functional design

With compatibility for multiple accessories, it offers multi-functional use in a single device.



Akıllı Yol Planlaması
Havuzun her köşesini verimli şekilde temizler.

Intelligent Path Plannig
It cleans every corner of the pool efficiently.



Kullanım kılavuzuna ulaşmak için QR kodu okutun.

Scan the QR code to access the user manual.



KOD CODE	ÖNERİLEN HAVUZ BOYUTU RECOMMENDED POOL SIZE	ŞARJ SÜRESİ CHARGING TIME	GÜÇ POWER	AĞIRLIK WEIGHT	FİYAT PRICE
19815273204	< 500m ²	6 Saat Hour	100W	9,4 kg	3.800 €

Goodrob King 1250

NETA HAVUZ
PRODUCT

MAXIMUM GÜÇ MAXIMUM POWER

Büyük havuzlar için tasarlanmış kablosuz bir robottur. 8 saatlik çalışma süresi, 6 L filtre haznesi ve akıllı navigasyonu profesyonellere üstün performans sunar.

A cordless robot designed for large pools. With 8 hours of runtime, a 6 L filter basket, and smart navigation, it delivers superior performance for professionals.

KABLOSUZ
CORDLESS8 SAAT ÇALIŞMA SÜRESİ
8 HOURS WORKING TIMEDUVARA TIRMANIR
CLIMB THE WALL6 SAAT ŞARJ OLUR
6 CHARGING TIME

IP X8



CE

Öne Çıkan Özellikler Product Features

Tasarım ve Kullanım

- » Kablosuz tasarım
- » Betonarme, liner ve polyester havuzlarda kullanım
- » Büyük havuzlarda kullanım ($\leq 1250 \text{ m}^2$)

Performans ve Çalışma

- » 8 saate kadar çalışma süresi
- » 370Wh batarya kapasitesi
- » 100W güçlü motor (60W opsiyonel hızlı şarj)
- » AdaptiveNav 3.0 akıllı yol planlama
- » 3 farklı çalışma seçeneği: taban, duvar, taban + duvar
- » Günlük ve haftalık olmak üzere 2 temizlik modu
- » Taban, duvar, su çizgisi ve köşe temizliği
- » Otomatik ve manuel temizlik modları

Filtrasyon

- » 6L geniş filtre haznesi
- » 25 mikrona kadar filtreleme

Kullanım Kolaylığı

- » Otomatik park etme ve self-rescue özelliği
- » Uzaktan kumanda ve mobil uygulama ile kontrol

Design & Compatibility

- » Cordless design
- » Suitable for reinforced concrete, liner, and polyester pools
- » Designed for large pools ($\leq 1250 \text{ m}^2$)

Performance

- » Up to 8 hours of runtime
- » 370Wh battery capacity
- » Powerful 100W motor (optional 60W fast charging)
- » AdaptiveNav 3.0 smart path planning
- » 3 cleaning modes: floor, wall, floor + wall
- » 2 cleaning programs: daily and weekly
- » Cleans floor, walls, waterline, and corners
- » Automatic and manual cleaning modes

Filtration

- » Large 6L filter compartment
- » Filtration up to 25 microns

Ease of Use

- » Automatic parking and self-rescue feature
- » Remote control & mobile app operation

1+N çok fonksiyonlu tasarım

Farklı aksesuarlarla uyumlu yapısı sayesinde tek cihazla çok fonksiyonlu kullanım sağlar.

1+N multi-functional design

With compatibility for multiple accessories, it offers multi-functional use in a single device.



Akıllı Yol Planlaması

Havuzun her köşesini verimli şekilde temizler.

Intelligent Path Planning

It cleans every corner of the pool efficiently.

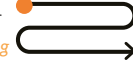

Kullanım kılavuzuna ulaşmak için QR kodu okutun.

Scan the QR code to access the user manual.



KOD CODE	ÖNERİLEN HAVUZ BOYUTU RECOMMENDED POOL SIZE	ŞARJ SÜRESİ CHARGING TIME	GÜÇ POWER	AĞIRLIK WEIGHT	FİYAT PRICE
19815273205	< 1.250m ²	6 Saat Hour	100W	9,4 kg	4.500 €

PoolVac™ V-Flex

Öne Çıkan Özellikler Product Features

- » Patentli V-Flex® teknolojisi, büyük parçacıkları bile yakalayarak optimum temizlik sağlar
- » AquaPilot® yönlendirme sistemi ile havuzun her noktasına ulaşır
- » Hidrodinamik tasarımı sayesinde serbest ve kesintisiz hareket eder
- » Elektrik bağlantısı gerektirmez; skimmer veya vakum nozulu ile çalışır
- » 6x12 m'ye kadar betonarme, liner ve polyester havuzlarda kullanılabilir
- » 10 dakikadan kısa sürede kurulumu hazırdır

- » Patented V-Flex® technology captures larger debris for optimum cleaning
- » Exclusive AquaPilot® steering system ensures complete pool coverage
- » Hydrodynamic design allows smooth and unhindered movement
- » No electrical connection required; operates via skimmer or vacuum nozzle
- » Suitable for reinforced concrete, liner, and polyester pools up to 6x12 m
- » Ready to use in less than 10 minutes

Performans videosu için QR kodu okutun.

Scan the QR code to watch performance video.



Patentli V-Flex® teknolojisi, büyük döküntüleri yakalamak için esnek kanatlara sahip bir türbine sahiptir.

V-Flex® patented technology features a turbine with flexible blades to capture large debris.

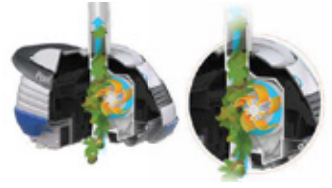

KOD CODE	HORTUM UZUNLUĞU HOSE LENGHT	MAX. HAVUZ ÖLÇÜSÜ POOL MAX. SIZE	FİYAT PRICE
14016273009	12 mt	6 m x 12 m	749 €



**Doğru
Havuz Temizleyiciyi
Seç**

**Pick the
Right Pool Cleaner**

Doğru havuz temizleyicisini seçerken şu temel kriterlere dikkat edin:

Havuz boyutu: Büyük havuzlar, geniş alan kaplayan ve uzun süre çalışabilen modeller gerektirir.

Kaplama tipi: Temizleyicinin seramik, liner veya beton gibi yüzeylerle uyumlu olması önemlidir.

Engeller: Merdiven, köşe veya zor erişimli alanlar varsa, bu bölgelerde etkili çalışabilen bir model tercih edin.

Temizlik özellikleri: Sadece tabanı mı yoksa duvar ve su çizgisini de temizlemesini istediğinizi belirleyin.

Akıllı fonksiyonlar: Programlanabilir döngüler, uzaktan kumanda veya engel algılama gibi seçenekler avantaj sağlar.

Bütçe: İhtiyaçlarınıza uygun, fiyat-performans açısından en iyi modeli seçin.

Choosing the right pool cleaner depends on a few key factors:

Pool size: Larger pools require cleaners with wider coverage and longer runtime.

Lining: Make sure the cleaner is compatible with your surface type (tile, liner, concrete, etc.).

Obstacles: If your pool has steps or tight corners, choose a model designed to handle complex shapes.

Cleaning features: Decide whether you need only floor cleaning or also walls and waterline.

Smart functions: Some models offer programmable cycles, remote control or obstacle detection.

Budget: Choose the model that offers the best performance within your budget.

HAYWARD TIGERSHARK ROBOTLARI KIYAS TABLOSU

HAYWARD TIGERSHARK ROBOT COMPARISON TABLE

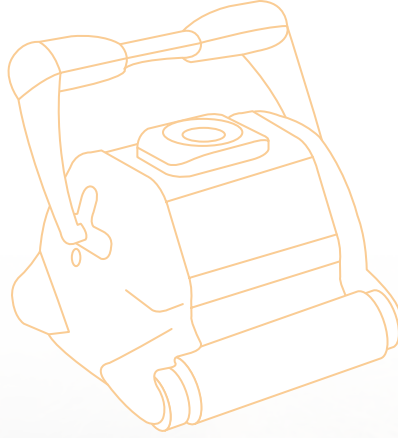

	TIGERSHARK	TIGERSHARK XL QC	TIGERSHARK 2
Havuz Ölçüsü Pool Size:	7x15 Mt	7x15 Mt	25x20 Mt
Temizlik Yüzei Cleaning Surface:	Taban ve Duvar Bottom and Wall	Taban ve Duvar Bottom and Wall	Taban ve Duvar Bottom and Wall
Hız Ground Speed:	18 m/Dak. 18 m/Min.	18 m/Dak. 18 m/Min.	--
Temizlik Alanı Cleaning Area:	5 m ² /dak. 5 m ² /min.	5 m ² /dak. 5 m ² /min.	--
Çalışma Süresi Operation Time:	4 Saat 4 Hours	90 Dak. (QC) / 4 Saat 90 Min. (QC) / 4 Hours	7 Saat 7 Hours
Kablo Uzunluğu Cable Length:	16,76 mt	16,76 mt	30 Mt
Yumuşak Sünger Soft Foam:	Evet Yes	7x15 Mt	7x15 Mt
Voltaj Voltage:	220 V/50/60 Hz	220 V/50/60 Hz	220 V/50/60 Hz
Filtrasyon Kapasitesi Filtration Capacity:	5 Mikron 5 Microns	5 Mikron 5 Microns	5 Mikron 5 Microns
Mikroproses Kontrolü Adaptative Seek Control Logic:	Evet Yes	Evet Yes	Evet Yes

TigerShark®

Öne Çıkan Özellikler Product Features

- » Akıllı mikroişlemci tabanlı teknoloji
- » Güçlü vakum gücü sağlayan dahili motor
- » 4 saatte taban, duvar ve basamakları temizler
- » Temizlik bitince otomatik durur
- » Kartuş filtreler kolayca hortumla durulanır
- » Ek pompa veya hortum gerektirmez
- » Filtrasyon sisteminden bağımsız çalışır, geri yıkamayı azaltır
- » 24V verimli motor ile düşük enerji tüketimi
- » Smart microprocessor-based technology
- » Built-in motor delivers strong vacuum power
- » Cleans pool floor, walls, and steps in 4 hours
- » Automatically stops after cleaning cycle
- » Cartridge filters easily rinsed with a garden hose
- » No extra pump or hose required
- » Operates independently from filtration system, reduces backwash
- » 24V efficient motor for low energy consumption



KOD CODE	HORTUM UZUNLUĞU HOSE LENGHT	MAX. HAVUZ ÖLÇÜSÜ POOL MAX. SIZE	EMİŞ KAPASİTESİ SUCTION CAPACITY	TEMİZLİK HIZI CLEANING SPEED	FİLTASYON HASSASİYETİ FILTRATION FINENESS	AĞIRLIK WEIGHT	FİYAT PRICE
14016273014	16,76 mt	7 m x 15 m	17 m³/h	18 m/min	30µ	11.40 kg	1.900 €

TigerShark® QC

Öne Çıkan Özellikler Product Features

- » 6 x 12 m'ye kadar konut tipi havuzlar için tasarlanmıştır
- » Havuz kaplamasına göre sünger veya konik kauçuk fırça seçeneği
- » 4 saatte taban, duvar ve su çizgisi temizliği
- » Quick Clean modu ile 90 dakikada tam temizlik
- » ASCL mikroişlemci teknolojisiyle optimize edilmiş temizlik
- » Güçlü vakum sistemiyle etkili kir ve tortu temizliği
- » Designed for residential pools up to 6 x 12 m
- » Available with foam or conical rubber brush options for different coatings
- » Cleans pool floor, walls, and waterline in 4 hours
- » Quick Clean mode completes full cleaning in just 90 minutes
- » Optimised cleaning with ASCL microprocessor technology
- » Powerful suction system for effective dirt and debris removal



KOD CODE	HORTUM UZUNLUĞU HOSE LENGHT	MAX. HAVUZ ÖLÇÜSÜ POOL MAX. SIZE	EMİŞ KAPASİTESİ SUCTION CAPACITY	TEMİZLİK HIZI CLEANING SPEED	FİLTASYON HASSASİYETİ FILTRATION FINENESS	AĞIRLIK WEIGHT	FİYAT PRICE
14016273013	16,76 mt	7 m x 15 m	17 m³/h	18 m/min	30µ	11.40 kg	1.950 €

TigerShark® XL QC™

Öne Çıkan Özellikler Product Features

- » Akıllı mikroişlemci teknolojisi
- » Güçlü vakum motoru
- » 4 saatte taban, duvar ve basamak temizliği
- » Süre bitince otomatik durma özelliği
- » Kartuş filtre kolayca temizlenir
- » Ek pompa veya hortum gerekmez
- » Filtrasyondan bağımsız çalışır, geri yıkamayı azaltır
- » 24V verimli motor ile düşük enerji tüketimi
- » Smart microprocessor technology
- » Powerful vacuum motor
- » Cleans floor, walls, and steps in 4 hours
- » Automatically stops when cycle ends
- » Cartridge filter is easy to clean
- » No extra pump or hose required
- » Operates independently from filtration, reduces backwash
- » 24V efficient motor ensures low energy use

Performans videosu için QR kodu okutun.

Scan the QR code to watch performance video.



KOD CODE	HORTUM UZUNLUĞU HOSE LENGHT	MAX. HAVUZ ÖLÇÜSÜ POOL MAX. SIZE	EMİŞ KAPASİTESİ SUCTION CAPACITY	TEMİZLİK HIZI CLEANING SPEED	FİLTASYON HASSASİYETİ FILTRATION FINENESS	AĞIRLIK WEIGHT	FİYAT PRICE
14016273011	16,76 mt	7 m x 15 m	17 m³/h	18 m/min	30µ	11.40 kg	1.950 €

TigerShark® 2

Öne Çıkan Özellikler Product Features

- » Ticari havuzlara uygundur
- » Akıllı mikroişlemci teknolojisi
- » Güçlü vakum motoru
- » 7 saatte taban, duvar ve basamak temizliği
- » Temizlik bitince otomatik durur
- » Kartuş filtre kolayca temizlenir
- » Ek pompa veya hortum gerekmez
- » Filtrasyondan bağımsız çalışır, geri yıkamayı azaltır
- » 24V verimli motor ile düşük enerji tüketimi
- » Suitable for commercial pools
- » Smart microprocessor technology
- » Powerful vacuum motor
- » Cleans floor, walls, and steps in 7 hours
- » Automatically stops when cycle ends
- » Cartridge filter is easy to clean
- » No extra pump or hose required
- » Operates independently from filtration, reduces backwash
- » 24V efficient motor ensures low energy consumption

Performans videosu için QR kodu okutun.

Scan the QR code to watch performance video.



Süngerli Foam



Fırçalı Brush

KOD CODE	HORTUM UZUNLUĞU HOSE LENGHT	MAX. HAVUZ ÖLÇÜSÜ POOL MAX. SIZE	EMİŞ KAPASİTESİ SUCTION CAPACITY	TEMİZLİK HIZI CLEANING SPEED	FİLTASYON HASSASİYETİ FILTRATION FINENESS	AĞIRLIK WEIGHT	FİYAT PRICE
14016273018 Fırçalı Brush	30 mt	25 m x 20 m	17 m³/h	5 m²/dk	5µ	19 kg	3.350 €
14016273017 Süngerli Foam	30 mt	25 m x 20 m	17 m³/h	5 m²/dk	5µ	19 kg	3.350 €



Sadece
havuz tabanını temizler
Cleans
just the pool floor



Sadece
havuz duvarını temizler
Cleans
the pool walls



Sadece
su hattını temizler
Cleans
the waterline



10 m x 20 m
havuz için
For pool 10 m x 20 m



Robotik
Robotic



7 saatlik
temizlik için
For cleaning
7 hours



Kolay kullanım için
30 m kablo
30 m cable for
easy use



Kanıtlanmış ve
güvenilir ürün
Proven &
reliable product



En iyi
fiyat performans oranı
Best Value for Money

Bilmekte fayda var!

TigerShark® 2, uzun yıllardır dünyanın her yerinde mükemmel bir temizlik aracı olduğunu kanıtlamıştır.

Good to know!

TigerShark® 2 has, for many years, proven itself to be a great cleaning asset all around the world.

Havuz Robotu Taşıma Arabası Caddy Card

Öne Çıkan Özellikler Product Features

- » Taşıma ve depolama yapar
- » Otomatik süpürge için kolay ve hızlı taşınmasını sağlar
- » Makes moving and storing
- » Provides easy and fast transport of the automatic cleaner



KOD CODE	AĞIRLIK WEIGHT	ÖLÇÜLER SIZE	UYUMLULUK COMPATIBILITY	FİYAT PRICE
19815273013	8 Kg	89 x 46 x 28 cm	TigerShark®, AquaVac® models	245 €

Havuz Kepçeleri Leaf Scoops

Derin Tip Kepçeler Deep Bottom Leaf Scoops

Öne Çıkan Özellikler Product Features

- » Havuzun dibindeki pislikleri almak için üretilmiştir
- » Derin torbası sayesinde pislikleri rahatça toplar
- » UV dayanımlı çerçeve
- » Kaliteli ve dayanıklı ağ
- » Her sapa uyumlu klipsli bağlantı
- » Made to get trash at the bottom of the pool
- » Thanks to its deep bag, it collects dirt easily
- » UV resistant frame
- » Quality and durable leaf
- » Suitable for every poles models with clip-on connection



KOD CODE	MODEL	FİYAT PRICE
14019123001	1 Taraklı Ekonomik Model <i>Economic Deep Bag Rake</i>	9 €
14019123002	2 Taraklı Lüks Model <i>Deluxe Deep Bag Rake</i>	11 €
14019123006	3 Kalın Yeşil Çerçevesi Lüks Model <i>Plastic Deep Leaf Rake In Green Color</i>	15 €

Satış Tip Kepçeler Surface Type Pool Leaf

Öne Çıkan Özellikler Product Features

- » Havuzun dibindeki pislikleri almak için üretilmiştir
- » Sığ torbası sayesinde yüzeyde biriken yaprak, böcek gibi kalıntıları kolayca toplar
- » UV dayanımlı çerçeve
- » Kaliteli ve dayanıklı ağ
- » Her sapa uyumlu klipsli bağlantı
- » Made to get trash at the bottom of the pool
- » Thanks to its shallow bag, it easily collects residues such as leaf insects on the surface
- » UV resistant frame
- » Quality and durable leaf
- » Suitable for every poles models with clip-on connection



KOD CODE	MODEL	FİYAT PRICE
14019123003	1 Standart Model Kepçe <i>Standart Leaf Skimmer</i>	7.25 €
14019123004	2 Plastik Lüks Model Kepçe <i>Heavy Duty Plastic Leaf Skimmer</i>	10.45 €
14019123005	3 Alüminyum Tutamaklı Kepçe <i>Leaf Skimmer With Aluminium Pole</i>	11.55 €

Havuz Fırçaları Pool Brushes

Öne Çıkan Özellikler Product Features

- » Havuz tabanını, duvarlarını ve köşelerini temizlemek için tasarlanmıştır
- » Beton ve liner havuzlarda kullanıma uygundur
- » Yosun ve inatçı kirlerin kolaylıkla temizlenmesini sağlarlar
- » Her sapa uyumlu klipsli bağlantı

- » Designed to clean pool floors, walls and corners
- » Suitable for use in concrete and liner pools
- » Allows easy removal the algae and stubborn dirt
- » Suitable for every poles models with clip-on connection



KOD CODE	MODEL	UZUNLUK LENGTH	FİYAT PRICE
14020123001	Kıvrık Plastik Telli Curved Plastic Wire Bristle Head	45 cm	8 €



KOD CODE	MODEL	UZUNLUK LENGTH	FİYAT PRICE
14020123002	Kıvrık Plastik Telli Alüminyum Destekli Curved Plastic Wire Bristle Head Aluminium Back	45 cm	13.50 €



KOD CODE	MODEL	UZUNLUK LENGTH	FİYAT PRICE
14020123003	Duvar Tip Düz Plastik Telli Wall Type Flat Plastic Wire Bristle Head	26 cm	5.90 €



KOD CODE	MODEL	UZUNLUK LENGTH	FİYAT PRICE
14020123004	Düz Paslanmaz Çelik Telli Flat Type Stainless Steel Wire Bristle Head	26 cm	12 €

Beton havuzlar içindir, sert çelik kıllar, havuz yüzeylerindeki yosun ve inatçı lekeleri kolayca temizler.

For concrete pools, stainless steel bristles easily remove algae and stubborn stains from pool surfaces.

Magic Eraser Temizlik Süngeri Magic Eraser

Öne Çıkan Özellikler Product Features

- » Nano teknolojisi ile üretilmiştir
- » Havuzda oluşan su kötü çizgilerinin temizlenmesinde mükemmel sonuç verir
- » Made with nano technology
- » It gives excellent results in cleaning the water level lines formed in the pool



KOD CODE	ÖLÇÜ SIZE	FİYAT PRICE
14021133001	7 x 11 cm	4,5 €

Havuz Ve Spa Termometreleri

Pool And Spa Thermometers

Güneş Enerjili Yüzen Termometre Solar Floating Thermometer

NEW



Öne Çıkan Özellikler Product Features

- » Güneş enerjisiyle çalışır, pil gerektirmez
- » Suya bırakıldığında 1-2 dakikada sıcaklığı ölçer
- » Fahrenheit ve Santigrat göstergeli geniş ekran
- » Yüksek hassasiyetli sensör ile doğru sıcaklık ölçümü
- » Dayanıklı gövde: oksidasyon ve korozyona karşı dirençli
- » 0°C-50°C (32°F-122°F) aralığında ölçüm yapar
- » "Aç/Kapat" ve "°C/°F" dönüştürme tuşları bulunur
- » Havuz, gölet, spa ve akvaryumlarda kullanıma uygundur
- » Solar panel sayesinde ekran sürekli açık kalır
- » Solar-powered, no battery required
- » Measures temperature within 1-2 minutes when placed in water
- » Large display with Fahrenheit and Celsius readings
- » High-precision sensor for accurate temperature detection
- » Durable, oxidation- and corrosion-resistant body
- » Measures within a 0°C-50°C (32°F-122°F) range
- » Features "ON/OFF" and "°C/°F" conversion buttons
- » Suitable for pools, ponds, spas, and aquariums
- » Solar panel keeps the display continuously on

Kullanım Notları

- Termometreyi doğrudan güneş ışığı altında bırakmayın. 60°C / 140°F üzerindeki sıcaklıklar ürünün ömrünü kısaltabilir.
- Gölge alanlarda kullanılması önerilir.
- Pil değişimi yapılmaz; gece çalışmaz ancak gündüz veya ışıklı ortamlarda ölçüm yapmaya devam eder.



Usage Notes

- Do not expose the thermometer to direct sunlight. Temperatures above 60°C / 140°F may shorten its lifespan.
- Recommended for use in shaded areas.
- Battery is not replaceable; does not operate at night but continues measuring during the day or under light sources.



KOD CODE	MALZEME MATERIAL	FİYAT PRICE
14515123009	PP	--

Öne Çıkan Özellikler Product Features

- » Havuz suyu sıcaklığını ölçmek için kullanılırlar
- » Kapalı havuzlarda ortam sıcaklığını ölçmek için de kullanılabilir
- » Su içerisinde kolay okunabilirler

- » Used to measure pool water temperature
- » Also can be used to measure ambient temperature in indoor pools
- » Easy to read in water



KOD CODE	MODEL	FİYAT PRICE
14515123001	Ekonomik Model İpiyle Birlikte <i>Economic Model With Rope</i>	6 €



KOD CODE	MODEL	FİYAT PRICE
14515123002	Lüks Model Yüzer, İpiyle Birlikte <i>Deluxe Model Floating With Rope</i>	6 €



KOD CODE	MODEL	FİYAT PRICE
14515123003	Jumbo Model İpiyle Birlikte <i>Jumbo Model With Rope</i>	13.50 €



KOD CODE	MODEL	FİYAT PRICE
14515123004	Ekonomik Model Renkli İpiyle Birlikte <i>Economic Model Color Type With Rope</i>	12 €



KOD CODE	MODEL	FİYAT PRICE
14515123005	Hayvan Modeli İpiyle Birlikte <i>Animal Form Floating With Rope</i>	5 €



KOD CODE	MODEL	FİYAT PRICE
14515123006	Hayvan Figürlü Yüzer İpiyle Birlikte <i>Animal Form Floating With Rope</i>	5 €



KOD CODE	MODEL	FİYAT PRICE
14515123008	Profesyonel Tip Yüzer <i>Deluxe Floating Dial</i>	26 €

HAVUZ DEZENFEKSİYON ÜRÜNLERİ

POOL DISINFECTION PRODUCTS

HAVUZ DEZENFEKSİYON EKİPMANLARI

POOL DISINFECTION EQUIPMENT

Havuz Suyunda Sağlık ve Güvenlik.
Health and Safety in Pool Water

Havuzlarda en etkili dezenfeksiyon çözümleri.
The most effective disinfection solutions for pools.

Neta Havuz, tuzdan klor jeneratörleri, UV sistemleri, dozaj pompaları ve test kitleri sunar. Otomatik kontrol sistemleriyle havuz suyunda hijyen ve denge kolayca sağlanır.

Neta Pool provides salt chlorinators, UV systems, dosing pumps, and test kits. Automatic control systems ensure hygiene and balance in pool water.

Clomax 200

Tuzdan Klor Jeneratörü Salt Chlorinator

WIFI İLE HİJYEN WI-FI HYGIENE

85 m³ havuz kapasitesine kadar yüksek verimle çalışan akıllı tuz klor jeneratördür. Wi-Fi kontrol ve BOOST modu sayesinde kullanıcıya hız, güvenlik ve tam hijyen sağlar.

Smart salt chlorinator that works efficiently for pools up to 85 m³. With Wi-Fi control and BOOST mode, it provides users with speed, safety, and complete hygiene.

ÖZEL AMAÇLI HAVUZ
RESIDENTAL POOL

TİP F FİŞ BAĞLANTISI
TYPE F PLUG

UYGUN FİYAT
COMPETITIVE PRICE

IP 54

WIFI KONTROL
WIFI CONTROL



NETA HAVUZ
PRODUCT

Öne Çıkan Özellikler Product Features

- » 85 m³ havuzlara kadar uygundur
- » IP 54 su geçirmezlik sınıfı
- » Online hat üstü kolay kurulum
- » Kompakt tasarımı sayesinde dar alanlara montaj imkanı
- » Wifi ile kumanda
- » Tuz az ikazı
- » Akış kontrol devresi
- » Dona karşı düşük sıcaklık ikazı
- » BOOST modu ile ilk devreye almada zaman kazanma
- » Available for up to 85 m³ swimming pools
- » IP 54 waterproof
- » Easy to install on pipeline
- » Can be applied to narrow spaces thanks to its compact design
- » Possibility of remote control thanks to wi-fi application
- » Low salt indicator
- » Flow switch
- » Low temperature warning against frost
- » Save time on first startup with BOOST MODE

Montaj Şeması Installation Diagram

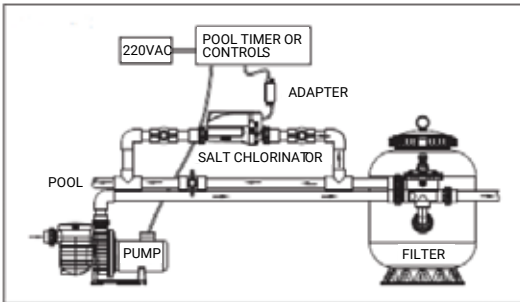

Kullanım kılavuzuna ulaşmak için QR kodu okutun.

Scan the QR code to access the user manual.



WiFi kurulumu izlemek için QR kodu okutun.

Scan the QR code to monitor the WIFI installation.



KOD CODE	MODEL	KLOR ÜRETİMİ CHLORINE	HAVUZ HACMİ POOL VOLUME	AKIM RATED CURRENT	GERİLİM RATED VOLTAGE	TUZ SEVİYESİ SALT LEVEL	SU SERTLİĞİ WATER HARDNESS	SU SICAKLIĞI WATER TEMP.	FİYAT PRICE
-	CLOMAX 4	4 gr/hr	18 m ³	1.5A	100-240V~50/60Hz	2700~4500PPM	≤200mg/L	10~45°C	-
-	CLOMAX 8	8 gr/hr	35 m ³	2.5A	100-240V~50/60Hz	2700~4500PPM	≤200mg/L	10~45°C	-
-	CLOMAX 12	12 gr/hr	50 m ³	2.5A	100-240V~50/60Hz	2700~4500PPM	≤200mg/L	10~45°C	-
-	CLOMAX 16	16 gr/hr	68 m ³	2.5A	100-240V~50/60Hz	2700~4500PPM	≤200mg/L	10~45°C	-
15521113072	CLOMAX 200	20 gr/hr	85 m ³	2.5A	100-240V~50/60Hz	2700~4500PPM	≤200mg/L	10~45°C	799 €

Clomax 500

Tuzdan Klor Jeneratörü Salt Chlorinator



6'SI BİR ARADA 6 IN ONE

PH Kontrol
PH Dozaj Pompası
Redox Kontrol
Tuz Klor Jeneratörü
WIFI-APP
Pompa Aç-Kapak İçin Kuru Kontak

PH Control
PH Dosing Pump
Redox Control
Salt Generator
WIFI-APP
Dry Contact For Pump Control



ÖZEL AMAÇLI HAVUZ
RESIDENTAL POOL



UYGUN FİYAT
COMPETITIVE PRICE



WIFI KONTROL
WIFI CONTROL



TUVA APP



Öne Çıkan Özellikler Product Features

- » Tuz seviyelerine otomatik uyum sağlar ve akıllı hatırlatmalar yapar
- » Tuz seviyesini kolay izleme için görüntüler
- » Optimum performansı sağlamak için su akışını izler
- » Boost fonksiyonu, gerektiğinde klorun üretimini hızla artırır
- » Farklı havuz koşulları ve ihtiyaçları için çeşitli modlar sunar
- » Havuz pompasının entegrasyonunu ve kontrolünü sağlar
- » Küresel kullanım için çoklu dil desteği sunar
- » Ters kutup teknolojisi ile kalsiyum birikimini önler
- » Güç kesintilerinde ayarları ve verileri korur
- » Yazılım geliştirmeleri için kablosuz güncelleme desteği
- » Uzun vadeli doğruluk için kolay kalibrasyon sağlar
- » Dahili topraklama elektrodu ile güvenliği sağlar

- » The system continuously monitors water quality in real-time
- » Efficient chlorination with adjustable frequency for optimized performance
- » Control and monitor the system remotely via a dedicated mobile app
- » Automatically adjusts to salinity levels and provides intelligent reminders
- » Displays current salt levels for easy monitoring
- » Monitors water flow to ensure optimal performance
- » Boost function rapidly increases chlorine production when needed
- » Offers various modes for different pool conditions and needs
- » Allows integration and control of the pool pump
- » Supports multiple languages for global usability
- » Prevents calcium buildup with pole inversion technology
- » Retains settings and data during power interruptions
- » Supports over-the-air updates for firmware enhancements
- » Ensures safety with a built-in grounding electrode

- Otomatik prb kontrolü
- Esnek kurulum
- Otomatik kimyasal dozajlama
- Düşük tuz uyarısı
- Automated probe control
- Flexible installation
- Automatic chemical dosing
- Low salt alert&salt addition prompts

- Havuz pompası için Modbus protokolü
- UI&UX 4.4" TFT ekran
- PH ve ORP probu değiştirilebilir
- IOT yükseltmesini destekler
- Modbus protocol and dry contact for pool pump
- UI&UX 4.3" TFT screen
- PH&ORP probe replaceable
- It supports IOT upgrade

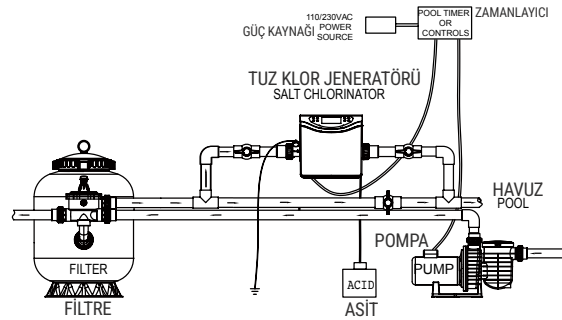

Kullanım kılavuzuna ulaşmak için QR kodu okutun.

Scan the QR code to access the user manual.



KOD CODE	MODEL	KLOR ÜRETİMİ CHLORINE	GÜÇ GİRİŞİ POWER INPUT	GÜÇ ÇIKIŞI POWER OUTPUT	TUZ ARALIĞI SALINITY RANGE	PH VALFİ PH VALVE	ORP SEVİYESİ ORP LEVEL	HAVUZ HACMİ POOL VOLUME	FİYAT PRICE
15521113080	CLOMAX 500	20 gr/hr	AC100-240V~50/60Hz	DC24V	2700-4500PPM	2700~4500PPM	400-800	≤90 m³	2.200 €

SSC Mini

Tuzdan Klor Jeneratörü Salt Chlorinator

MİNİ DEV MIGHTY MINI

90.000 litreye kadar havuzlarda verimli dezenfeksiyon sağlar. Titanyum hücreleri ve ters polarite teknolojisiyle dayanıklı ve kolay kullanımlıdır.

SSC Mini provides efficient disinfection for pools up to 90,000 liters. With titanium cells and reverse polarity, it is durable and easy to use.



ÇEVRE DOSTU
ECO-FRIENDLY

ÖZEL AMAÇLI HAVUZ
RESIDENTIAL POOL

Ti
TİTANYUM HÜCRE
TITANIUM CELLS



MAX.
2 BAR



Öne Çıkan Özellikler Product Features

- » 90.000 litreye kadar olan konut havuzları için tasarlanmıştır
- » Birkaç düğmeyle kolay işlemler
- » Mevcut tesisatlar için minimum boru modifikasyonları
- » Dayanıklı, uzun hücre ömrü ve ekonomik yedek parçalar mevcut
- » İyi performans, kimyasalların daha az kullanılması ve daha kaliteli su
- » Magnezyum tuzlu havuzlar için mükemmel uygunluk
- » Uygun fiyatlı yedek parçalar mevcut
- » Maksimum 20 gr / saat klor üretimi için titanyum plakalar
- » Kendi kendini temizleyen ters polarite, su akış sensörü ve sıcaklık sensörü
- » İki farklı bağlantıya sahip yarı saydam kasa: 1,5" / 50 mm veya 2" / 63 mm
- » Engineered for the residential pools up to 90,000 liters
- » Easy operations with few buttons
- » Minimum piping modifications for existing installations
- » Durable, long cell lifetime and economic spare parts available
- » Good performance, less handling of chemicals and better quality of water
- » Perfect suited for magnesium salted pools
- » Affordable spare parts available
- » Titanium plates for a maximum chlorine production of 20 gram/h
- » Self-cleaning reverse polarity, water flow sensor and temperature sensor
- » Translucent casing with two different connections: 1.5" / 50 mm or 2" / 63 mm

Önemli Important

Tuz Jeneratörü kullanılan havuzlarda paslanmaz aksamaların AISI 316 kalite olması gerekmektedir. 1 ton havuz suyu için yaklaşık 6 kg tuz kullanılması önerilir.

Stainless parts must be of AISI 316 quality in the pools where salt generator is used. It is recommended to use approximately 6 kg of salt for 1 ton of pool water.

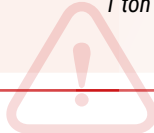

KOD CODE	KLOR ÜRETİMİ CHLORINE	HAVUZ HACMİ POOL VOLUME	VOLTAJ / FREKANS VOLTAGE FREQUENCY	FİYAT PRICE
15521123007	20 gr/hr	90.000 Liters	200-240v / 50-60 Hz	1.199 €

SSC 50

Tuzdan Klor Jeneratörü Salt Chlorinator

DENİZ DAYANIMI SEA RESISTANT

SSC 50, titanyum hücreleri ve ters polarite özelliğiyle uzun ömürlü dezenfeksiyon sağlar. Deniz suyu kullanıma uygun yapısıyla dayanıklı ve güvenlidir.

SSC 50 ensures long-lasting disinfection with titanium cells and reverse polarity. Designed for durability, it is also suitable for use in sea water.

ÖZEL AMAÇLI HAVUZ
RESIDENTIAL POOL

TİCARİ HAVUZ
COMMERCIAL POOL

ÇEVRE DOSTU
ECO-FRIENDLY

Ti
TİTANYUM HÜCRE
TITANIUM CELLS



Öne Çıkan Özellikler Product Features

- » Kendi kendini temizleyen ters polarize özelliği
- » Kalite titanyum hücre
- » Işıklı uyarı sinyalizasyonu
- » Deniz suyu kullanıma uygundur
- » Self-cleaning reverse polarizer feature
- » Quality titanium cells
- » Luminous warning signalization
- » Suitable for use in sea water

Önemli İportant

Tuz Jeneratörü kullanılan havuzlarda paslanmaz aksamaların AISI 316 kalite olması gerekmektedir. 1 ton havuz suyu için yaklaşık 6 kg tuz kullanılması önerilir.

Stainless parts must be of AISI 316 quality in the pools where salt generator is used. It is recommended to use approximately 6 kg of salt for 1 ton of pool water.

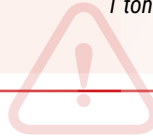

Yedek Hücre Spare Cell



KOD CODE	MODEL	FİYAT PRICE
19818123004	15 gr / h	745 €
19818123005	25-45 gr / h	700 €



Yedek Hücre Kılıfı Spare Cell Cover

KOD CODE	MODEL	FİYAT PRICE
19818123022	15-25-45 gr / h	60 €

KOD CODE	KLOR ÜRETİMİ CHLORINE	HAVUZ HACMİ POOL VOLUME	VOLTAJ / FREKANS VOLTAGE FREQUENCY	FİYAT PRICE
15521123010	15 gr / hr	45 m³	200v AC 50/60 Hz	1.043 €
15521123009	25 gr / hr	70 m³	200v AC 50/60 Hz	1.320 €
15521123008	45 gr / hr	170 m³	200v AC 50/60 Hz	1.390 €

G Serisi Wifi

G Series Wifi

Tuzdan Klor Jeneratörü Salt Chlorinator

DİJİTAL HİJYEN

DIGITAL HYGIENE

G Series WiFi, pH ve ORP kontrolüyle havuz suyunu akılcıca dengeler. Wi-Fi/Bluetooth bağlantısı ve LED dokunmatik ekranıyla modern ve kolay kullanım sunar.

G Series WiFi smartly balances pool water with pH and ORP control. With Wi-Fi/Bluetooth connectivity and a LED touch display, it offers modern and easy operation.

ÖZEL AMAÇLI HAVUZ
RESIDENTIAL POOL

2 KG
HAFIF
LEIGHT WEIGHT

WIFI KONTROL
WIFI CONTROL

LED



MY POOL
APP



CE

Öne Çıkan Özellikler

Product Features

- » Wi-Fi/Bluetooth/harici LAN üzerinden bağlanın
- » pH ve ORP kontrol sistemi, havuz örtüsü modu
- » Peristaltik / diyaframlı dozaj pompası ile çalışır
- » Max. klor üretim doğruluğu (%5)
- » Otomatik kış koruması
- » Yüksek koruma sınıfı ve su sıçramasına dayanıklı
- » Asit seviye deposu göstergesi
- » Akıllı ekran: 3 ledli dokunmatik düğme sistemi
- » Connect via Wi-Fi/Bluetooth/external LAN
- » pH and ORP control system, pool cover mode
- » Sealed and splash-proof
- » Max. chlorine production accuracy ($\pm 5\%$)
- » Operates with peristaltic/diaphragm dosing pumps
- » Automatic winter protection
- » Sealed and splash-proof
- » Acid tank level indicator
- » Smart display: 3-LED touch button system

Otomasyon

- Pompa, aydınlatma, şelale ve diğer özelliklere bağlanan dört çıkış
- İki AUX çıkışı
- Filtre basınç sensörü



Automation

- Four outlets connecting to pump, lighting, waterfall and other features
- Two AUX outputs
- Filter pressure sensor

KOD CODE	MODEL	KLOR ÜRETİMİ CHLORINE	HAVUZ HACMİ POOL VOLUME	VOLTAJ VOLTAGE	TUZ SEVİYESİ SALT LEVEL	FİYAT PRICE
15521273024	G12	12 gr / hr	50 m ³	110-220 V	1.500-7.000PPM	--
15521273025	G18	14 gr / hr	60 m ³	110-220 V	1.500-7.000PPM	3.220 €
15521273026	G40	26 gr / hr	120 m ³	110-220 V	1.500-7.000PPM	3.490 €
15521273027	G60	36 gr / hr	150 m ³	110-220 V	1.500-7.000PPM	3.670 €

S Serisi

S Series

Tuzdan Klor Jeneratörü Salt Chlorinator

KOLAY KURULUM

EASY SETUP

S Series, sektördeki en basit kurulumu sahip tuz klor jeneratörüdür. Değişken hızlı pompalar ve çift akış sensörüyle güvenli ve uyumlu çalışır. *S Series is the salt chlorinator with the simplest installation in the industry. It works safely and compatibly with variable speed pumps and dual flow sensors.*

ÖZEL AMAÇLI HAVUZ
RESIDENTAL POOL

LED



CE

Öne Çıkan Özellikler

Product Features

- » Sektördeki en basit kurulum
- » Değişken hızlı pompalarla çalışmak üzere tasarlanmış
- » Çift yönlü akış sensörü, çift "düşük akış" koruması
- » Dahili tuzluluk ve su sıcaklık sensörleri
- » The simplest installation in the industry
- » Designed to work with variable speed pumps
- » Bi-directional flow sensor, double "low flow" protection
- » Built-in salinity and water temperature sensors

Kontrol Paneli Ekranı

- 24 saat süper klorlama modu
- Servis ve bakım alarmları
- 4 tuşlu işlem
- LED göstergesi
- Otomatik polarizasyon ile hücre temizliği



Control Panel Secreen

- 24 hours super chlorination mode
- Service and maintenance built in alerts
- 4-button operation
- LED indicator
- Clean cell identification and alert

Kullanım kılavuzuna ulaşmak için QR kodu okutun.

Scan the QR code to access the user manual.



KOD CODE	MODEL	KLOR ÜRETİMİ CHLORINE	HAVUZ HACMİ POOL VOLUME	VOLTAJ VOLTAGE	BORU PIPE	FİYAT PRICE
15521273020	S12	12 gr / hr	50 m ³	110-220 V	63/50 cm	--
15521273021	S18	14 gr / hr	60 m ³	110-220 V	63/50 cm	1.780 €
15521273022	S40	26 gr / hr	120 m ³	110-220 V	63/50 cm	1.930 €
15521273023	S60	36 gr / hr	150 m ³	110-220 V	63/50 cm	2.170 €

KLX

Tuzdan Klor Jeneratörü Salt Chlorinator

HAVUZ YÖNETİMİ POOL MANAGER

KLX, yalnızca bir tuz jeneratörü değil; pH, Rx ve pompa hızını da kontrol eden akıllı bir sistemdir. IP65 koruması ve Wi-Fi desteğiyle her şartta güvenli kullanım sunar.

KLX is more than a salt chlorinator; it is a smart system that controls pH, Rx, and pump speed. With IP65 protection and Wi-Fi support, it ensures safe operation in all conditions.

ÖZEL AMAÇLI HAVUZ
RESIDENTIAL POOL

DÜNYA MARKASI
GLOBAL BRAND

TİCARİ HAVUZ
COMMERCIAL POOL

WIFI KONTROL
WIFI CONTROL

MADE IN
EU



Öne Çıkan Özellikler Product Features

- » Sadece tuz jeneratörü değil aynı zamanda tüm havuz operasyonunuzu kontrol edebilen bir sistemdir
- » 8-50 gr/saat klor üretebilen kapasitesi 20/200 m³ havuzlara uygun
- » IP 65 koruması sayesinde polyester makine dairelerinde dahil her şartta kullanım
- » Satın aldığınız tek üniteye ilave edilebilen opsiyon kitleri
- » PH kontrol (dozaj pompası ile birlikte)
- » Rx kontrol
- » WIFI ile mobil cihazlarda uzaktan kontrol sistemi
- » Kripsol KSX Pro VS, KS Evo VS model pompalarıyla birlikte kullanılması halinde pompa hız kontrolü programlama
- » 3 yıl veya 8000 saat hücre garantisi
- » Tüm filtrasyon pompası markalarıyla uyumludur ve KLX üzerinden doğrudan kontrol edilebilir
- » Opsiyonel sıcaklık sensörü, Ethernet bağlantısı ve MODBUS protokol desteği sunar
- » Entegre güvenlik sistemleri: akış dedektörü ve gaz dedektörü (hücrenin dikey montajı için)
- » It is not only a salt generator but also a system that can control your entire pool operation
- » Capable of producing 8-50 gr / hour chlorine, suitable for pools of 20/200 m³
- » Thanks to its IP 65 protection, can be used in all conditions, including in polyester machine rooms
- » Option kits that can be added to a single unit purchased
- » PH control (with dosing pump)
- » Rx control
- » Remote control system on mobile devices with WIFI
- » Programming pump speed control when used with Kripsol KSX Pro VS, KS Evo VS model pumps
- » 3 years or 8000 hours cell warranty
- » Compatible with any filtration pump brand and can be operated directly via the KLX system
- » Optional temperature sensor, Ethernet connection, and MODBUS protocol support
- » Integrated safety features: flow detector and gas detector (for vertical cell installation)

Klx tuzdan klorlar
Sugar Valley
tarafından
üretilmektedir.



*Klx Salt Chlorine is
produced by Sugar Valley.*

HAYWARD
POOL PRODUCTS

Kullanım videosunu
izlemek için QR kodu
okutun.



*Scan the QR code to
watch the usage video.*

KOD CODE	MODEL	HAVUZ HACMİ POOL VOLUME	VOLTAJ / FREKANS VOLTAGE FREQUENCY	FİYAT PRICE
15521113054	KLX 8	20 m ³	200v	1.395 €
15521113050	KLX 16	50 m ³	200v	1.455 €
15521113066	KLX 22	90 m ³	200v	1.670 €
15521113065	KLX 33	150 m ³	200v	2.030 €
15521113049	KLX 50	200 m ³	200v	3.725 €
15521113053	pH kiti	-	-	630 €
15521113152	RX kiti	-	-	600 €
15521113051	WIFI Modülü	-	-	816 €

KLB

Tuzdan Klor Jeneratörü Salt Chlorinator

AKILLI KLOR POOL MANAGER

9 farklı seviyede klor üretimiyle ihtiyaçlarınıza uygun çözüm sunar. Tak-çalıştır özelliği sayesinde hızlıca devreye alınır.

Offers 9 different chlorine production levels to suit your needs. Easily activated with its plug & play feature.

ÖZEL AMAÇLI HAVUZ
RESIDENTAL POOL

DÜNYA MARKASI
GLOBAL BRAND

rX
HARİCİ KONTROL
EXTERNAL CONTROL

8.000 SAAT HÜCRE
8.000 HOURS
WARRANTY CELL

MADE IN
EU



€

Öne Çıkan Özellikler Product Features

- » Led ekran sayesinde üretim konfigürasyonu
- » Üretim kontrolü için şeffaf hücre
- » Havuz koruması tespit edip klor üretimini ayarlama
- » Akış dedektörü kiti dahil
- » 9 seviyede klor üretimi mümkün
- » Tak çalıştır özelliği
- » Production configuration thanks to the LED display
- » Transparent cell for visual checks on production
- » Detection of presence of a pool cover for adjustment of chlorine production
- » Flow detector kit included
- » 9 levels possible of chlorine production
- » Plug and play

Önemli Important

Hücrenin boru tesisatına montajı dikey konumda, by-pass üzerinde, tesisatların en yüksek noktasında montaj.

Installation of the cell in piping installation in a vertical position, on by-pass, at the highest point of the installations.



KOD CODE	MODEL	HAVUZ HACMİ POOL VOLUME	KORUMA PROTECTION	FİYAT PRICE
15521113154	16 g/h	75 m³	IP 65	1.200 €

Neosal Tuz Jeneratörü Neosal Salt Chlorinator

Tuzdan Klor Jeneratörü Salt Chlorinator

ESNEK KLORLAMA FLEXIBLE CHLORINATION

Geniş tuzluluk aralığı ve programlanabilir öz temizlik özelliğiyle havuzlara uyum sağlar. Güvenilir performansı ile farklı tipte havuzlarda kullanılabilir.

Adapts to your pool with wide salinity range and programmable self-cleaning. Reliable performance suitable for various pool types.

ÖZEL AMAÇLI HAVUZ
RESIDENTIAL POOL

TİCARİ HAVUZ
COMMERCIAL POOL

DÜNYA MARKASI
GLOBAL BRAND

MAX.
2 BAR



Öne Çıkan Özellikler Product Features

- » 3 gr/litre ile 100 gr/litre aralığında tuzluluk
- » Yanmaz siyah ABS plastik elektronik kutu
- » Mavi ABS plastik koruma kapağı
- » 16 bit mikro işlemcili
- » Akış kontrolü: Gaz sensörü
- » Üretim kontrolü: gr/saat
- » Alarmlar: Akış eksikliği, Bellek hatası
- » İsteğe bağlı: Mekanik akış sensörü

- » Salinity between 3 gr/liter and 100 gr/liter
- » Fireproof black ABS plastic electronic box
- » Blue ABS plastic protection cover
- » 16 bit microprocessor
- » Programmable self-cleaning from 1 to 24 hours
- » Flow control: Gas sensor
- » Production control: gr/hour
- » Optional: Mechanical flow sensor

Sistem Bağlantı Şeması System Connection Diagram



- 1 Elektronik kutu *Electronic box*
- 2 Elektroliz hücresi *Electrolysis cell*
- A Filtrasyon pompası zamanlayıcısı *Filtration pump timer*
- B Silex / cam / diatom filtre *Silex / glass / diatom filter*
- C Devir daim pompası *Recirculation pump*

KOD CODE	KLOR ÜRETİMİ CHLORINE	HAVUZ HACMİ POOL VOLUME	VOLTAJ VOLTAGE	FİYAT PRICE
15521113063	50 gr/hr	80 m ³	200v	5.727 €
15521113073	95 gr/hr	120 m ³	200v	7.500 €
15521113071	155 gr/hr	325 m ³	200v	9.500 €
15521113074	200 gr/hr	350 m ³	200v	14.000 €
15521113057	250 gr/hr	500 m ³	200v	18.500 €
15521113056	350 gr/hr	700 m ³	200v	19.795 €
15521113068	500 gr/hr	1.000 m ³	200v	31.195 €
15521113055	750 gr/hr	1.500 m ³	200v	46.792€
15521113067	1.000 gr/hr	2.000 m ³	200v	62.390 €

Blue Lagoon Tech UV-C

UV-C TEKNOLOJİSİ UV-C TECHNOLOGY

Paslanmaz çelik reaktör ile %35'e kadar daha yüksek verim sunar. Klor kullanımını %80'e kadar azaltarak profesyonel projelerde güvenilir bir çözüm sağlar.

Delivers up to 35% higher efficiency with stainless steel reactor. Reduces chlorine use by up to 80%, ensuring a reliable solution for professional projects.

AISI 316
PASLANMAZ ÇELİK GÖVDE
STAINLESS STEEL BODY

ÇEVRE DOSTU
ECO-FRIENDLY

MAX. 2 BAR



Öne Çıkan Özellikler Product Features

- » Havuz suyunu çevre dostu şekilde temiz ve berrak tutar
- » UV-C radyasyonu bakteri ve virüsleri nötralize eder
- » Klor kullanımını %50-80 oranında azaltır
- » Paslanmaz çelik iç yüzey verimliliği %35'e kadar artırır
- » Ø63-Ø50 mm adaptörler dahildir
- » 16W, 40W, 75W modeller özel T5 UV lamba ile donatılmıştır
- » 130W Amalgam versiyon akış anahtarı içerir
- » Amalgam lamba sıcaklık dalgalanmalarından etkilenmez
- » Amalgam UV-C ışığı pazardaki en güçlü ışık olarak bilinir
- » Çelik reaktör yansımalarıyla %35'e kadar ek verim sağlar
- » Keeps pool water clean, fresh and eco-friendly
- » UV-C radiation neutralizes bacteria and viruses
- » Reduces chlorine use by 50-80%
- » Stainless steel interior increases efficiency up to 35%
- » Ø63-Ø50 mm adapters included
- » 16W, 40W, 75W models with special T5 UV lamp
- » 130W Amalgam version includes flow switch
- » Amalgam lamp is unaffected by temperature changes
- » Known as the most powerful UV-C light on the market
- » Stainless steel reactor reflection provides up to 35% more yield



Avantajları

- Kolay kurulum ve bakım sayesinde duruş sürelerini (downtime) en aza indirir
- AISI 316L paslanmaz çelik gövde, yüksek korozyon direnci sağlar
- Evrensel bağlantılar dahildir (63mm / 50mm / 1/2" BSPP dişi)
- Gelişmiş UV-C sterilizasyonu ile verimli, sağlıklı ve temiz su artımı sunar
- Otomatik polarizasyon ile hücre temizliği

Advantages

- Easy to install and maintain, minimizing downtime
- 316L stainless steel housing offers superior corrosion resistance
- Universal fittings included (63mm / 50mm / 1/2" BSPP female)
- Efficient UV-C treatment ensures clean and healthy water

Önerilen Debi Recommended Flow Rate for 30 mJ/cm ²	Max. Debi Max. Flow Rate	Giriş-Çıkış Inlet-Outlet	Reaktör Yüksekliği Height of reactor in	Giriş-Çıkış Arası Mesafe Distance Between Inlet/Outlet
5	23 m ³ /h	63-50 mm	56 cm ±	34 cm ±
11	23 m ³ /h	63-50 mm	100 cm ±	77 cm ±
16	23 m ³ /h	63-50 mm	100 cm ±	77 cm ±
22	23 m ³ /h	63-50 mm	100 cm ±	77 cm ±

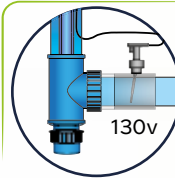

UV-C
amalgam
lambası
amalgam lamp

Kullanım videosunu izlemek için QR kodu okutun.



Scan the QR code to watch the usage video.

KOD CODE	WATT	HAVUZ HACMİ POOL VOLUME	BAĞLANTI CONNECTION	AĞIRLIK WEIGHT	FİYAT PRICE
15520123003	12	10 m ³	50 mm	2,8 kg	500 €
15520123004	16	15 m ³	50-63 mm	2,8 kg	625 €
15520123006	40	40 m ³	50-63 mm	3,6 kg	695 €
15520123007	75	75 m ³	50-63 mm	3,9 kg	715 €
15520123005	130	150 m ³	50-63 mm	5,0 kg	1.336 €

High Reflexion UV: HR-UVC

MAX. VERİM MAX. EFFICIENCY

Yüksek UV yansıtma teknolojisi ile mikroorganizmaların UV'ye maruziyetini %95'e kadar artırır. Kimyasal kullanımını azaltarak profesyonel projelerde güvenilir sonuçlar sağlar.

With advanced UV reflection technology, it increases microorganism exposure to UV by up to 95%. Reduces chemical use while ensuring reliable results in professional projects.

9.000 SAAT HÜCRE
9.000 HOURS
WARRANTY CELL

ÇEVRE DOSTU
ECO-FRIENDLY

TUZLU SUDA KULLANILIR
USE IN SALT WATER

MAX.
3 BAR

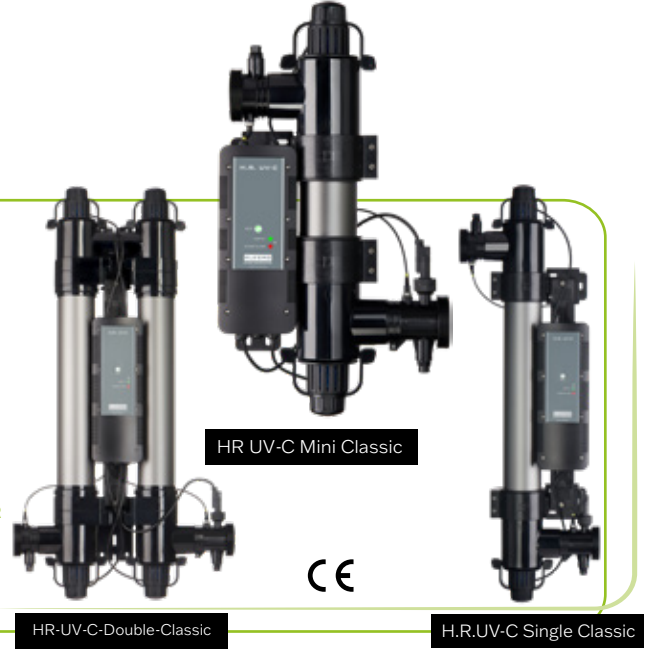

Öne Çıkan Özellikler Product Features

- » Piyasadaki en yüksek UV yansıtma verimliliği
- » Mikroorganizmaların UV'ye maruziyetini %95'e kadar artırır
- » Zararlı gaz veya yan ürün üretmez
- » Kimyasalların yapmadığı bakteri, virüs, yosun ve mantarları nötralize eder
- » Güçlü sterilizasyon sağlar, klor kokusunu ortadan kaldırır
- » Ortalama lamba ömrü: 2 yıl
- » Akıllı lamba ömrü göstergesi bulunur
- » Tuzlu ve deniz suyunda kullanıma uygundur
- » UV-C lamba ömrü: 9.000 saate kadar

- » Highest UV reflective efficiency on the market
- » Increases microorganism UV exposure up to 95%
- » Produces no harmful gases or by-products
- » Neutralizes bacteria, viruses, algae and fungi beyond chemicals
- » Provides strong sterilization and eliminates chlorine odor
- » Average lamp life: 2 years
- » Equipped with intelligent lamp life indicator
- » Suitable for salt and sea water use
- » UV-C lamp life up to 9,000 hours

MİKROORGANİZMALARINI
NÖTRALİZE EDER

NEUTRALISES
All micro-organisms including



Bakteri
Bacteria



Virüsler
Viruses



Yosun
Algae



Tek Hücreliler
Protozoa

%60'a kadar kimyasal azaltma Up to 60% chemical reduction

MODEL	KOD CODE	HAVUZ TIPI FOR POOL TYPE			ANALOG LAMBA ÖMÜR GÖSTERGELİ DIGITAL LAMP LIFE INDICATOR	PRİZ PLUG	AKIŞ ANAHTARI FLOW SWITCH	DİKEY-YATAY MONTAJ VERTICAL OR HORIZONTAL MOUNTABLE
		YERÜSTÜ HAVUZ ABOVE GROUND	EV TIPI RESIDENTIAL	SU PARKLARI AQUATICS				
Mini Standart	15520123116	✓	✓	✓			✓	
Mini Classic	15520123029	✓	✓	✓	✓	✓	✓	
Single Standart	15520123117		✓	✓			✓	
Single Classic	15520123013		✓	✓	✓	✓	✓	
Double Standart	15520123027		✓	✓			✓	
Double Classic	15520123017		✓	✓	✓	✓	✓	

KOD CODE	WATT	HAVUZ HACMİ POOL VOLUME	TÜP TUPE	LAMBA GÖSTERGESİ LAMP SIGN	MAX DEBİ m ³ /h MAX FLOW m ³ /h	BRÜT Kg GROSS Kg	FİYAT PRICE
15520123029	30	30 m ³	30	✓	15	6,06	--
15520123013	55	55 m ³	55	✓	21	9,05	955 €
15520123017	110	110 m ³	110	✓	42	12,45	1.370 €
15520123116	30	30 m ³	30	✗	15	6,06	1.575 €
15520123117	55	55 m ³	55	✗	21	9,01	--
15520123027	110	110 m ³	110	✗	42	10,01	--

Quantum UV-C

FOTOKATALİTİK GÜÇ PHOTOCATALYTIC POWER

Fotokatalitik ve hidroksil radikal teknolojisi ile kirleticileri yok eder. Daha az kimyasal ihtiyacıyla güçlü sterilizasyon sağlar.

Eliminates pollutants with photocatalytic and hydroxyl radical technology. Provides strong sterilization with reduced need for chemicals.

14.000 SAAT HÜCRE
14.000 HOURS
WARRANTY CELL

MAX.
3 BAR

CE

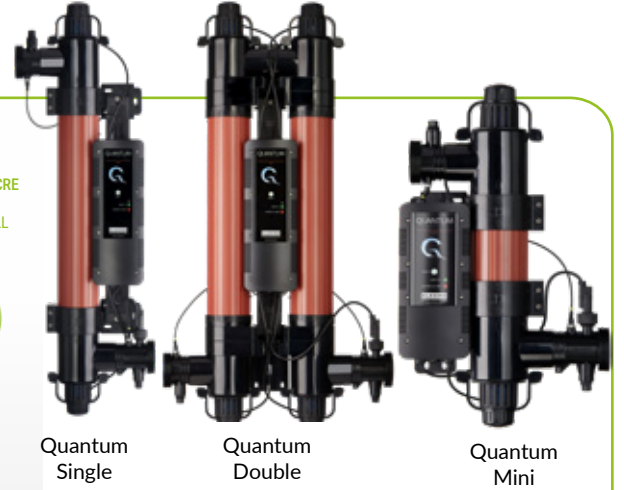

Öne Çıkan Özellikler Product Features

- » Uv sistemi ile kombine edilmiş fotokatalitik ve hidroksil radikal teknolojisi en nükemmel kalitede su elde edilmesini sağlar
- » Kirletici maddeleri yok eder, suyun taze ve temiz görünmesini sağlar
- » Havuzdaki kimyasallara olan ihtiyacı azaltır
- » Güçlü sterilizasyon sağlar ve klor kokusunu ortadan kaldırır
- » Ortalama lamba ömrü: 2 yıl
- » Akıllı lamba ömrü göstergesi ile donatılmıştır
- » Tuzlu su ve deniz suyunda kullanıma uygundur

- » Photocatalytic and hydroxyl radical technology combined with UV system ensures the highest quality water
- » It destroys pollutants and makes the water look fresh and clean
- » Reduces the need for chemicals in the pool
- » Strong sterilization eliminates the smell of chlorine
- » Average lamp life expectancy: 2 years
- » Equipped with intelligent lamp life indicator
- » Suitable for use in salt water and sea water

Fotokatalitik Oksidasyon Photocatalytic Oxidation

Fotoğraf-katalizör Titanyum Dioksit
Photo-catalyst Titanium Dioxide

Kirleticilere Saldırı
Attacking Harmful Pollutants

Zararsız H₂O & Co₂ Açığa Çıkması
By product Harmless H₂O & Co₂

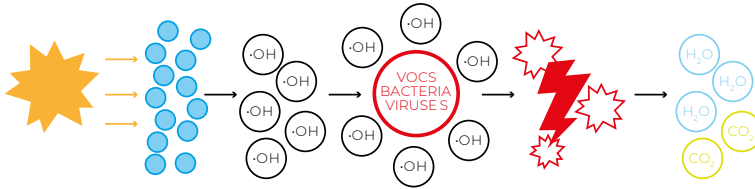

Ultraviole Işınları
Ultra Violet Light

Oksitleyici Hidroksil Radikalleri Oluşumu
Oxidizing Hydroxyl Radicals Formed

Hücrelerin Yok Edilmesi
Destruction of cells



KOD CODE	WATT	HAVUZ HACMİ POOL VOLUME	TÜP TUBE	MAX DEBİ m ³ /h MAX FLOW m ³ /h	ÜRÜN BOYUTU (UZUNLUK) PRODUCT SIZE (LENGTH)	FİYAT PRICE
15520123028	30	35 m ³	Mini Classic	10	623 mm	1.350 €
15520123016	55	65 m ³	Tek Single	14	981 mm	1.720 €
15520123015	110	130 m ³	Çift Double	28	981 mm	2.715 €

Spectrum

PRO UV DEZENFEKSİYON PRO UV DISINFECTION

Büyük ölçekli ve yoğun kullanımlı ticari havuzlar için yüksek kapasiteli UV dezenfeksiyon çözümüdür. Kimyasal ihtiyacı azaltır, su berraklığını artırır ve sürdürülebilir işletme sağlar.

A high-capacity UV sanitation solution designed for large-scale, high-use commercial pools. Reduces chemical consumption, enhances water clarity and supports sustainable operation.

TİCARİ HAVUZ
COMMERCIAL POOL

TUZLU SUDA KULLANILIR
USE IN SALT WATER



Öne Çıkan Özellikler Product Features

- » Standart model: LED gösterge ve lamba ömrü sayacı
- » Classic & Pro modeller: 7" dokunmatik ekran
- » Pro model: Dozaj oranı izleme ekranı
- » CFD analizine göre optimize edilmiş tasarım
- » Quick-Fit bağlantı: Lambalar saniyeler içinde değiştirilebilir
- » 316L paslanmaz çelik veya titanyum hazne seçeneği
- » Wi-Fi ve bulut bağlantısı (Classic & Pro)
- » Deniz suyu ve tuz klorlayıcılarla uyumlu
- » Sıcaklık, akış sensörü ve pompa ara bağlantısı
- » UV yoğunluk portu (Classic & Pro)
- » 16.000 saat ömürlü düşük basınç amalgam lambalar
- » 6 bar çalışma basıncı toleransı
- » Gelişmiş bildirim özellikli Plug & Play kontrolcü
- » RS485 ile mevcut sistemlere kolay entegrasyon

- » Standard model: LED indicator & lamp life counter
- » Classic & Pro: 7" touch screen interface
- » Pro: Dosage rate monitoring
- » Optimised design using CFD analysis
- » Quick-Fit connection for lamp replacement in seconds
- » 316L stainless steel or titanium chamber options
- » Wi-Fi & cloud connectivity (Classic & Pro)
- » Compatible with sea water & salt chlorinated pools
- » Temperature, flow sensor & pump interlock
- » UV intensity port (Classic & Pro)
- » Low-pressure amalgam lamps with 16,000-hour life
- » 6-bar working pressure tolerance
- » Plug & Play controller with advanced notifications
- » Easy RS485 integration to existing systems

Teknik döküman için
QR kodu okutun.

Scan the QR code to
data sheet.



ÜRÜN KODLARI PRODUCT CODE

AKIŞ HIZI m²/h FLOW RATE (AVERAGE IRRADIANCE)

STANDART STANDARD	KLASİK CLASSIC	PRO	LAMBA GÜCÜ LAMP OUTPUT	LAMBA ADEDİ NO OF LAMBS	TOPLAM GÜÇ TOTAL POWER	30 mj/cm ²	40 mj/cm ²	60 mj/cm ²
SP-S-57-102	SP-C-57-102	SP-P-57-102	57 W	1	70	5.7	4.2	2.8
SP-S-150-102	SP-C-150-102	SP-P-150-102	150 W	1	170	20	14	9
SP-S-200-102	SP-C-200-102	SP-P-200-102	207 W	1	230	25	18	12
SP-S-150-170	SP-C-150-170	SP-P-150-170	150 W	1	150	34.5	26	17
SP-S-200-170	SP-C-200-170	SP-P-200-170	200 W	1	230	43	32	21.5
SP-S-300-170	SP-C-300-170	SP-P-300-170	150 W	2	350	62	46	31
SP-S-400-170	SP-C-400-170	SP-P-400-170	200 W	2	460	77	58	38.5
SP-S-450-212	SP-C-450-212	SP-P-450-212	150 W	3	510	112	83	55
SP-S-620-212	SP-C-620-212	SP-P-620-212	200 W	3	660	133	102	68
SP-S-600-260	SP-C-600-260	SP-P-600-260	150 W	4	680	170	127	85
SP-S-800-260	SP-C-800-260	SP-P-800-260	200 W	4	880	212	159	106
SP-S-960-310	SP-C-960-310	SP-P-960-310	320 W	3	1050	279	209	139
SP-S-1600-310	SP-C-1600-310	SP-P-1600-310	320 W	5	1720	428	320	213
SP-S-2240-310	SP-C-2240-310	SP-P-2240-310	320 W	7	2450	590	442	294

KUANTUM TEKNOLOJİSİ

QUANTUM TECHNOLOGY

İLERİ OKSİDASYON

ADVANCED OXIDATION

Fotokatalitik oksidasyon ve hidroksil radikaller, biyolojik ya da biyolojik olmayan kirleticileri etkili şekilde yok eder. Bu ileri teknoloji, profesyonel projelerde en güçlü sterilizasyon yöntemlerinden birini sunar.

Photocatalytic oxidation and hydroxyl radicals effectively eliminate both biological and non-biological pollutants. This advanced technology provides one of the strongest sterilization methods for professional projects.

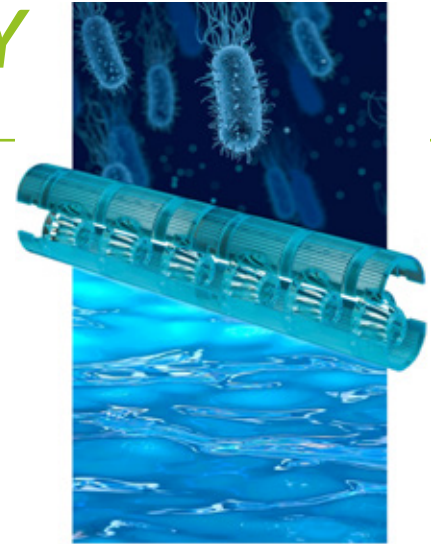

Reaksiyon 1: Fotokatalitik Oksidasyon (PCO)

- » Kuantum'un temel işlevi, fotokatalitik reaksiyon yoluyla oksidasyondur.
- » Reaksiyon odasında, elmaslardan daha yüksek kırılma indisine sahip titanyum dioksit nano-kristal katalizör yüzeyi bulunur.
- » 254 nm dalga boyundaki ultraviyole ışık bu yüzeye çarpar.
- » Su varlığında gerçekleşen PCO reaksiyonu, bilinen en güçlü sterilizasyon etkilerinden birini ortaya çıkarır ve suyu hidroksil radikallere okside eder.
- » Bu süreç, katalitik yüzeyde biyolojik veya biyolojik olmayan tüm kirleticileri yok eder.

Reaction 1: Photocatalytic Oxidation (PCO)

- » The primary function of Quantum is oxidation by photocatalytic reaction.
- » Inside the chamber, a titanium dioxide (anatase) nano-crystal catalyst surface with a higher refractive index than diamonds is used.
- » Ultraviolet light at 254 nm strikes this catalyst surface.
- » In the presence of water, a PCO reaction occurs, producing one of the strongest sterilization effects and oxidizing the water into hydroxyl radicals.
- » Photocatalytic oxidation on the catalyst surface destroys all pollutants, biological or non-biological.

KUANTUM

QUANTUM

Reaksiyon 2: Reaktif Oksijen Türleri (ROS)

- » Reaktif oksijen türleri, eşleşmemiş elektronlara sahip, sudan türeyen ve PCO reaksiyonu ile üretilen, son derece reaktif moleküllerdir.
- » Bu son derece hareketli moleküller, odacığı doldurur, oldukça uçucudur ve yollarına çıkan her şeyi yok edebilir.



- » Reaktif Oksijen Türleri, kirletici ile reaksiyona girdiğinde kendini tekrar suya ve CO₂'ye dönüştürür.

Reaction 2: Reactive Oxygen Species (Ros)

- » Reactive oxygen species are molecules derived from water with unpaired electrons, highly reactive, produced by the PCO reaction.
- » These exceptionally mobile molecules that fill the chamber are highly volatile and able to destroy everything in their path.



- » Once the Reactive Oxygen Species reacts with the pollutant, it converts itself back into water and CO₂.

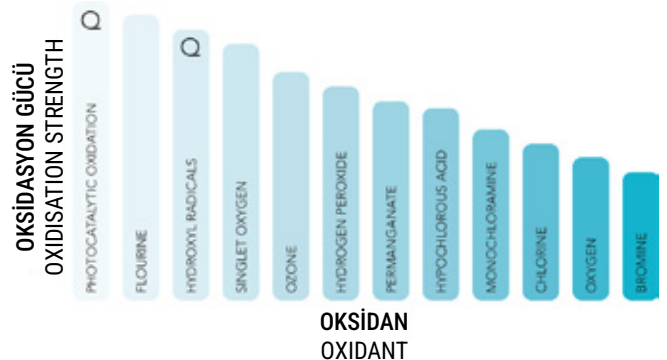
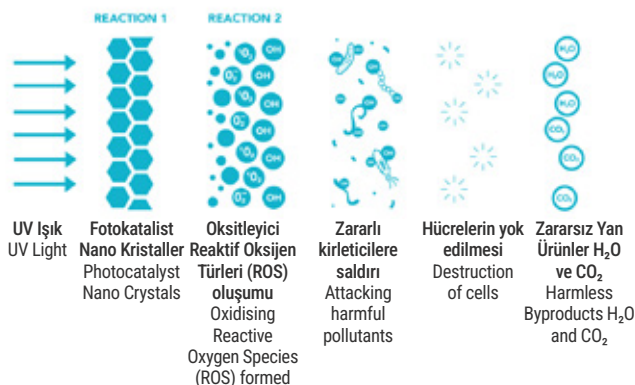



Platinum-Activated-Photocatalyst
Unpolluted ♦ Healthy ♦ Pure
Shimmering crystal-clear water



Supreme Sterilisation
Legionella ♦ Protozoa ♦ E. Coli
Naegleria fowleri ♦ Cryptosporidium
Organics ♦ Urea ♦ Skin Cells
Suntan Oil ♦ Pollutants Destroyed

FW UV

UZUN ÖMÜR LONG LIFE

FW UV, toksik yan ürünler oluşturmadan çevre dostu dezenfeksiyon sağlar. 13.000 saat ömürlü UV lambasıyla uzun süre güvenilir performans sunar.

FW UV delivers eco-friendly disinfection without producing toxic by-products. Its 13,000-hour UV lamp ensures long-lasting and reliable performance.

ÖZEL AMAÇLI HAVUZ
RESIDENTAL POOL

TİCARİ HAVUZ
COMMERCIAL POOL

ÇEVRE DOSTU
ECO-FRIENDLY

5-year guarantee

UZUN ÖMÜRLÜ
UV LAMBA
LONG LIFE UV LAMP



CE

Öne Çıkan Özellikler Product Features

- » Çevre dostu ve sağlıklı bir işlem olup, doğal havuzların dezenfeksiyonunda kullanılır
- » Alerjileri, mukoza zarları, göz, cilt ve saç tahrişini önler
- » Suda veya havada hoş olmayan koku oluşmaz
- » Toksik yan ürün içermez
- » Doğrudan filtrasyon devresinde kolay kurulum imkanı
- » Kontrol mikroşilemcili UV sensörü ve UV verimliliğinin sürekli ölçüm imkanı
- » 13.000 saatlik uzun ömürlü UV lamba
- » Eco-friendly and healthy process, used to disinfect natural pools
- » Prevents allergies and irritation of the eyes, skin, hair and mucous membranes
- » No unpleasant smell in the water or the air
- » No toxic by-products
- » Easy installation, directly in the filtration circuit
- » UV sensor with control microprocessor and continuous measurement of UV efficiency
- » Long UV lamp life (13,000 hours)

Farklı akış hızları için bizimle iletişime geçin. Bu cihazların performansı lamba ömrünün sonunda ve %98 geçirgenlikle hesaplanmıştır.
For different flow rates, contact us. The performance of these devices was calculated at the end of lamp life and with 98% transmittance.

Önemli Important

TİCARİ HAVUZLAR VE SU PARKLARI İÇİN UV FAYDALARI:

- Güvenli ve etkili dezenfeksiyon.
- Birleşik klor oranının %75'e kadar düşürülmesi ortalama 0,1 ila 0,3 ppm seviyesine.
- Yenilenmesi gereken su miktarında azalma.
- Daha iyi hava ve banyo kalitesi.
- Isıtma ve nem giderme maliyetlerinin optimizasyonu.
- Basit bakımla kolay ve hızlı kurulum.
- Tesisin 9 ila 24 ay arasında amortismanı.
- Korozyonun azaltılması.
- Çevreye saygı: İşletmenin imajının iyileşmesi.

UV BENEFITS FOR PUBLIC POOLS AND WATER PARKS:

- Safe and effective disinfection.
- A reduction of up to 75% of the combined chlorine rate to an average level of 0.1 to 0.3 ppm.
- Decrease in the amount of water to be renewed.
- Better air and bathing quality.
- Optimization of heating and dehumidification costs.
- Easy and quick installation with simple maintenance.
- Amortization of the facility between 9 to 24 months.
- Reduction of corrosion.
- Respect for the environment: improved image of the establishment.

KOD CODE	MAX. DEBİ m³/h MAX FLOW RATE m³/h	UV LAMBA GÜCÜ UV LAMP POWER	BAĞLANTI CONNECTION	REAKTÖR UZUNLUĞU REACTOR LENGTH	FİYAT PRICE
FW3150 HO	15	3x87 W	2" 1/2	1143 mm	--
FW3205 HO	22	3x87 W	3"	1150 mm	--
FW4205 HO	30	4x87 W	3"	1150 mm	--
FW5205 HO	37	5x87 W	3"	1150 mm	18.028 €
FW6205 HO	43	6x87 W	4"	1146 mm	--
FW6273 HO	67	6x87 W	4"	1162 mm	--

UV MPL / MPL SD

MEGA KAPASİTE MEGA CAPACITY

UV MPL/MPL SD, 400 m³/saate kadar kapasitesiyle kloraminleri yok eder. Paslanmaz çelik gövdesi ve 10.000 saatlik lamba ömrüyle dayanıklıdır.

UV MPL/MPL SD removes chloramines with up to 400 m³/h capacity. Its stainless steel body and 10,000-hour lamp ensure durability.

TİCARİ HAVUZ
COMMERCIAL POOL

ÇEVRE DOSTU
ECO-FRIENDLY

AISI
316
PASLANMAZ ÇELİK GÖVDE
STAINLESS STEEL BODY

MAX.
PN3

UZUN ÖMÜRLÜ
UV LAMBA
LONG LIFE UV LAMP

12.000 SAAT HÜCRE
12.000 HOURS
WARRANTY CELL

KOROZYONU AZALTIR
REDUCE CORROSION



CE

Öne Çıkan Özellikler Product Features

- » UV MPL/ MPL SD serisi, 400 m³/saat'e kadar akış hızında ticari ve yarı ticari havuzlardaki suyun kloraminasyonunu gidermek için tasarlanmıştır.
- » Orta basınçlı lambaları, cilt tahrişine neden olan suda bulunan kloraminleri ve göz ve solunum tahrişine neden olan havada bulunan trikloraminleri tamamen yok eder
- » Dezenkloraminasyon garantisi için MPL serisi, 60 mJ/cm² ışın yoğunluğu sağlar (lamba ömrünün sonunda bile).
- » Aşındırıcı sular için paslanmaz çelik veya Süper Dupleks (SD) malzeme seçeneği
- » Lamba ömrü: 10.000 saat
- » Elektrik panosunda ve reaktörde isteğe bağlı sıcaklık sensörü
- » Optimum alan gereksinimi
- » Bazı modellerde dokunmatik ekranla birlikte opsiyonel MODBUS iletişimi bulunur

5-year guarantee

- » The UV MPL/ MPL SD range has been designed for dechloramination of water in commercial and semicommercial pools at a flow rate of up to 400 m³/hr
- » Its medium-pressure lamps completely destroy chloramines present in the water, responsible for skin irritation, and trichloramines present in the air, responsible for eye and respiratory irritation
- » To guarantee dechloramination, the MPL range delivers 60 mJ/cm² (including at the end of lamp life)
- » Stainless steel or Super Duplex (SD), for corrosive water
- » Lamp life: 10,000 hours
- » Temperature sensor in electrical cabinet and reactor (as option)
- » Optimum space requirement
- » Some models include optional MODBUS communication with touchscreen control

KOD CODE	MAX. DEBİ m ³ /h MAX FLOW RATE m ³ /h	UV LAMBA GÜCÜ UV LAMP POWER	BAĞLANTI CONNECTION	REAKTÖR UZUNLUĞU REACTOR LENGHT	FİYAT PRICE
MPL030 EL 270W	10	1 x 270 W	DN 80	326 mm	--
MPL030 EL 400 W	20	1 x 400 W	DN 100	396 mm	--
MPL030 EL 600 W	30	1 x 600 W	DN 100	396 mm	--
MPL030 EL 1000W	50	1 x 1 kW	DN 100	396 mm	--
MPL030 EL 1800W	80	1 x 1,8 kW	DN 125	398 mm	--
MPL140	140	1 x 1,8 kW	DN 150	600 mm	--
MPL230	230	1 x 3 kW	DN 200	600 mm	--
MPL300	300	1 x 3 kW	DN 250	600 mm	--
MPL500	450	1 x 4,5 kW	DN 350	800 mm	--
MPL030 SD 270W	10	1 x 270 W	DN 80	326 mm	--
MPL030 SD 400W	20	1 x 400 W	DN 100	396 mm	--
MPL030 SD 600W	30	1 x 600 W	DN 100	396 mm	--
MPL030 SD 1000W	50	1 x 1 kW	DN 100	396 mm	--
MPL030 SD 1800W	80	1 x 1,8 kW	DN 125	405 mm	--
MPL140 SD	140	1 x 1,8 kW	DN 150	600 mm	--
MPL230 SD	230	1 x 3 kW	DN 200	600 mm	--
MPL300 SD	300	1 x 3 kW	DN 250	600 mm	--
MPL500+ SD	450	1 x 5 kW	DN 350	800 mm	--
MPL700 	700	2 x 1.8 kW	DN200	920 mm	--
MPL900 	900	2 x 1.8 kW	DN250	1150 mm	--

MP TS UV

ENDÜSTRİYEL UV INDUSTRIAL UV

MP TS UV, 900 m³/saate kadar kapasitesiyle kloraminleri yok eder. Dokunmatik ekran ve otomatik temizlik opsiyonlarıyla profesyonellere uygundur.

MP TS UV removes chloramines with up to 900 m³/h capacity. Touchscreen and auto-clean options make it ideal for professionals.



TİCARİ HAVUZ
COMMERCIAL POOL



ÇEVRE DOSTU
ECO-FRIENDLY



AISI
316
PASLANMAZ ÇELİK GÖVDE
STAINLESS STEEL BODY

DOKUNMATİK EKРАН
WITH TOUCH SCREEN



UZUN ÖMÜRLÜ
UV LAMBA
LONG LIFE UV LAMP



12.000 SAAT HÜCRE
12.000 HOURS
WARRANTY CELL



KOROZYONU AZALTIR
REDUCE CORROSION



MAX.
PNT0

CE

5-year guarantee

Öne Çıkan Özellikler Product Features

- » Ticari ve yarı ticari havuzlarda 900 m³/saate kadar dezenkloraminasyon sağlar
- » Orta basınçlı lambalar, sudaki kloraminleri ve havadaki trikloraminleri yok eder
- » 60 mJ/cm² ışın yoğunluğu ile dezenkloraminasyon garantisi sunar (lamba ömrü sonunda bile)
- » Opsiyonel dokunmatik ekran: parametre görüntüleme, gerçek zamanlı veri, 6 dil seçeneği
- » Standart manuel kuvars kılıf temizleme (opsiyonel otomatik versiyon)
- » Elektrik panosu ve reaktörde opsiyonel sıcaklık sensörü
- » Manuel veya otomatik lamba temizleme seçenekleri
- » Kompakt tasarımıyla alan verimliliği sağlar
- » Provides dechloramination for commercial and semi-commercial pools up to 900 m³/h.
- » Medium-pressure lamps eliminate chloramines in water and trichloramines in the air.
- » Guarantees 60 mJ/cm² irradiation for dechloramination (even at end of lamp life).
- » Optional touchscreen: parameter display, real-time data, 6 language options.
- » Standard manual quartz sleeve cleaning (automatic version optional).
- » Optional temperature sensor in cabinet and reactor.
- » Manual or automatic lamp cleaning options.
- » Compact design ensures space efficiency.

KOD CODE	MAX. DEBİ m ³ /h MAX FLOW RATE m ³ /h	UV LAMBA GÜCÜ UV LAMP POWER	BAĞLANTI CONNECTION	REAKTÖR UZUNLUĞU REACTOR LENGHT	FİYAT PRICE
MP030 600W EL	30	1 x 600 W	DN 80	491 mm	--
MP030 1kW EL	40	1 x 1 kw	DN 80	491 mm	--
MP100 TS	80	1 x 1 kw	DN125	1175 mm	--
MP125 TS	140	1 x 3 kw	D150	1152 mm	--
MP140 TS	300	1 x 3 kw	DN200	1244 mm	--
MP240 TS	450	2 x 3 kw	DN250	1020 mm	--
MP340 TS	675	3 x 3 kw	DN300	725 mm	--
MP440 TS	900	4 x 3 kw	DN300	824 mm	--

Ozon Jeneratörleri Ozone Generators

Öne Çıkan Özellikler Product Features

- » Güç kaynağını ve ozon çıkış haznesini üzerinde bulunduran kutu tipi cihazlardır
- » Hava kaynaklıdır
- » Hava soğutmalıdır
- » Venturi, checkvalf, hava kurutma ünitesi ve çıkış hortumu dahildir
- » Portatiftir
- » Box type devices that contain the power source and ozone outlet reservoir
- » Ozone generator with clean air source
- » With air-cooling
- » Includes venturi, check valve, air dryer unit and outlet hose
- » Portable

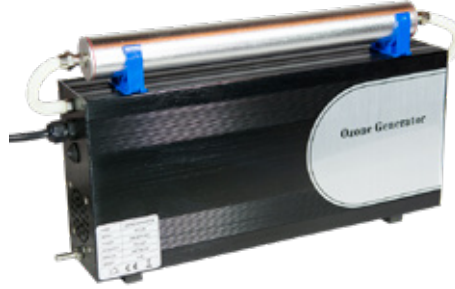

KOD CODE	MODEL	HAVUZ HACMI POOL VOLUME	FİYAT PRICE
15522123001	0,5 gr/h	50m ³	853 €
15522123002	1 gr/h	100m ³	1.558 €

Öne Çıkan Özellikler Product Features

- » Ayarlanabilir ozon üretimi
- » Paslanmaz çelik dış kabin
- » 65 lt hava pompası
- » Hava soğutmalıdır
- » Hava kaynaklı ve oksijen kaynaklı kullanılabilir
- » Portatiftir
- » Adjustable ozone output
- » Stainless steel outer cabinet
- » Containing 65 lt air compressor inside
- » With air-cooling
- » Both air source and oxygen source are acceptable
- » Portable



Dünyanın en büyük tematik akvaryumundaki balıklar, Waterfun Ozon Jeneratörleri ile yaşıyor!



The fish in the world's largest thematic aquarium lives with Waterfun Ozone Generators!

KOD CODE	MODEL	HAVUZ HACMI POOL VOLUME	FİYAT PRICE
15522123014	3 gr/h	300m ³	2.084 €
15522123004	5 gr/h	500m ³	2.547 €
15522123010	10 gr/h	1.000m ³	3.263 €
15522123005	20 gr/h	--	--
15522123006	30 gr/h	--	--
15522123007	50 gr/h	--	--
15522123009	80 gr/h	--	--

Dozaj Pompaları Dosage Pumps

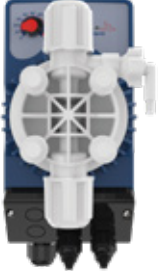

Kompact Model

KOD CODE	DEBİ Lt / h FLOW Lt / h	BASINÇ POWER	FİYAT PRICE
15515253088	5	8	290 €
15515253089	3	10	280 €

- » Analog dozaj pompası
- » %10-100 debi ayar oranı
- » Emme basma çekvalf kiti dahildir
- » Seviye sensör çıkışı mevcuttur
- » PVDF kafalı
- » Analog dosing pump
- » %10-100 flow regulating rate
- » Suction and discharge checkvalve kit is included
- » Level sensor output available
- » PVDF head



Kompact DRP 200 Model

KOD CODE	DEBİ Lt / h FLOW Lt / h	BASINÇ POWER	FİYAT PRICE
15515253056	5	8	710 €

- » Dijital pH/ORP ölçümlü dozaj pompası
- » PVDF -T kafalı
- » Seviye sensör çıkışı mevcuttur
- » Sensör tutucu ve kalibrasyon sıvısı dahil değildir
- » Dosing pump with digital pH/ORP measurement
- » PVDF-T head
- » Level sensor output available
- » Sensor holder and calibration liquid excluded



TRP 603 Model

KOD CODE	DEBİ Lt / h FLOW Lt / h	BASINÇ POWER	FİYAT PRICE
15515253073	8	2	1.300 €

- » Dijital pH/ORP ölçümlü dozaj pompası
- » PVDF kafalı
- » Seviye sensör çıkışı mevcuttur
- » 4-20 mA çıkışı sayesinde veri aktarımı
- » Sıcaklık sensör çıkışı mevcuttur
- » Sensör tutucu ve kalibrasyon sıvısı dahildir
- » Dosing pump with digital pH/ORP measurement
- » PVDF head
- » Level sensor output available
- » Data transfer thanks to 4-20 mA output
- » Temperature sensor output available
- » Sensor holder and calibration liquid are included



Tekna Evo AKS Model

KOD CODE	MODEL	DEBİ Lt / h FLOW Lt / h	BASINÇ POWER	FİYAT PRICE
15515253053	AKS 603	5	10	425 €
15515253070	AKS 800	10	10	570 €
15515253069	AKS 803	15	5	735 €

- » Analog dozaj pompası
- » PVDF kafalı
- » Ekran düğmesiyle seçilebilen iki frekans aralığı. (0 ÷ % 20 veya 0 % 100)
- » Analog dosing pump
- » PVDF head
- » Two frequency ranges (0÷20% or 0÷100%) selectable by display button

Otomatik Kontrol Sistemleri

Automatic Control Systems



Pool Dose Panel

KOD CODE	MAX. HAVUZ HACMİ MAX. POOL VOLUME	POMPA KAPASİTESİ PUMP CAPACITY	FİYAT PRICE
15515253075	100 m ³	5 Lt / 1,5 bar	1.510 €

- » Wifi kontrollü
- » Peristaltik pompalı dezenfeksiyon ünitesi
- » pH ve ORP elektrodları kalibrasyon sıvıları ve emme basma hortumları sisteme dahildir
- » Wifi control
- » Disinfection unit with peristaltic pump
- » pH and ORP electrodes, electrode holder, calibration fluids and suction-force hoses are included in the system



Kemidose Panel

KOD CODE	MAX. HAVUZ HACMİ MAX. POOL VOLUME	POMPA KAPASİTESİ PUMP CAPACITY	FİYAT PRICE
15515253080	450 m ³	5 Lt / 1,5 bar	1.565 €

- » Wifi kontrollü
- » Solenoid pompalı dezenfeksiyon ünitesi
- » pH ve ORP elektrodları kalibrasyon sıvıları ve emme basma hortumları sisteme dahildir
- » Wifi control
- » Disinfection unit with solenoid pump
- » pH and ORP electrodes, electrode holder, calibration fluids and suction-force hoses are included in the system

Otomatik Kontrol Sistemleri

Automatic Control Systems



Evo Basic Panel

KOD CODE	MAX. HAVUZ HACMİ MAX. POOL VOLUME	POMPA KAPASİTESİ PUMP CAPACITY	FİYAT PRICE
15515253077	500 m ³	5 lt / 8 bar	1.970 €

- » Solenoid pompalı dezenfeksiyon ünitesi
- » pH ve ORP elektrodları kalibrasyon sıvıları ve emme basma hortumları sisteme dahildir
- » 4-20 mA çıkışlı

- » Disinfection unit with solenoid pump
- » pH and ORP electrodes, electrode holder, calibration fluids and suction-force hoses are included in the system
- » 4-20 mA output



AKS 800 / 803 Panel

KOD CODE	MODEL	MAX. HAVUZ HACMİ MAX. POOL VOLUME	POMPA KAPASİTESİ PUMP CAPACITY	FİYAT PRICE
15515253063	AKS 800	1.500 m ³	10 Lt / 10 bar	2.890 €
15515253061	AKS 803	2.500 m ³	10 Lt / 10 bar	3.250 €

- » 0-14 pH / 0-999 mV göstergeli
- » pH ve ORP elektrodları kalibrasyon sıvıları ve emme basma hortumları sisteme dahildir

- » With display of 0-14 pH / 0-999 mV
- » pH and ORP electrodes, electrode holder, calibration fluids and suction-force hoses are included in the system

Otomatik Kontrol Sistemleri

Automatic Control Systems



K 800 CL Panel

KOD CODE	MAX. HAVUZ HACMİ MAX. POOL VOLUME	POMPA KAPASİTESİ PUMP CAPACITY	FİYAT PRICE
15515253074	1.500 m ³	10 Lt / 10 bar	6.255 €

- » Bakiye klor (0-5 ppm) ve pH (0-14) ölçümlü (ölçüm cihazı)
- » Uzaktan izleme ve kontrol imkanı sunan ölçüm kontrol sistemi
- » Klor elektrodu ve ph elektrodu dahildir
- » Dozaj pompaları fiyata dahil değildir. Talebe göre pompa konulabilir

- » Residual chlorine (0-5 ppm) and pH (0-14) measurement (measuring device)
- » The measurement control system provides remote monitoring and control facilities
- » Chlorine probe and ph probe included
- » Pumps not included in prices. Dosing pumps can be additional option



AKL 800 / 803 Panel

KOD CODE	MODEL	MAX. HAVUZ HACMİ MAX. POOL VOLUME	POMPA KAPASİTESİ PUMP CAPACITY	FİYAT PRICE
15515253062	AKL 800	1.500 m ³	10 Lt / 10 bar	2.960 €
15515253060	AKL 803	2.500 m ³	10 Lt / 10 bar	3.380 €

- » 0-14 pH / 0-999 mV göstergeli
- » pH ve ORP elektrodları kalibrasyon sıvıları ve emme basma hortumları sisteme dahildir
- » Seviye sensör çıkışı mevcuttur

- » With display of 0 -14 pH / 0 -999 mV
- » pH and ORP electrodes, electrode holder, calibration fluids and suction-force hoses are included in the system
- » Level sensor output available

Tuz Jeneratörü Kontrol Cihazları

Control Divices Salt Generator



Poolone Peristaltik Dozaj Pompası Poolone Peristaltic Dosing Pump

KOD CODE	MODEL	KAPASİTE CAPACITY	BASINÇ PRESSURE	ÖLÇÜM ARALIĞI MEASURING RANGE	FİYAT PRICE
164252005	Poolone	1,5 L/ h	1,5 bar	6,6 - 8 pH	520 €
164252006	Poolone	1,5 L/ h	1,5 bar	0 - 1000 mV	520 €

- » Dijital pH veya redox (RX) ölçümlü dozaj pompası; sensör, hat tipi prob tutucu, kalibrasyon sıvıları ve bağlantı aksesuarlarıyla komple settir. Özellikle tuz jeneratörlü havuzlarda pH kontrolü için uygundur.
- » By-pass hazneli prob tutucu opsiyoneldir.
- » Uygun havuz hacmi: 10 – 100 m³

- » Digital dosing pump with pH or Redox (RX) measurement; includes sensor, in-line probe holder, calibration solutions, and connection accessories. Ideal for pH control in pools with salt chlorinators.
- » By-pass probe holder with chamber is optional.
- » Suitable pool volume: 10 – 100 m³.



Kompact DRP 200 Model Set

KOD CODE	DEBİ Lt / h FLOW Lt / h	BASINÇ BAR PRESSURE	FİYAT PRICE
15515253090	5	8	1.010 €

- » Dijital pH/ORP ölçümlü dozaj pompası
- » PVDF -T kafalı
- » Seviye sensör çıkışı mevcuttur
- » Prob kalibrasyon sıvısı ve aksesuarlar dahildir

- » Dosing pump with digital pH/ORP measurement
- » PVDF-T head
- » Level sensor output available
- » Probe calibration fluid and accessories are included

Dozaj Pompası Ekipmanları

Dosing Pumps Equipment



Emiş Filtresi ve Çekvalfi Suction Filter and Check Valve

KOD CODE	FİYAT PRICE
19818253019	45 €

PVDF-T'den üretilmiştir.
Made from PVDF-T



Basma Çekvalfi Discharge Check Valve

KOD CODE	FİYAT PRICE
19818253020	35 €

PVDF-T'den üretilmiştir.
Made from PVDF-T



Kalibrasyon Sıvıları Calibration Fluid Kit

KOD CODE	TANIM DESCRIPTION	FİYAT PRICE
19818002003	Ph Kalibrasyon Sıvısı (4-7) <i>Ph Calibration Liquid (4-7)</i>	45 €
19818002004	ORP Kalibrasyon Sıvısı (465 mV) <i>ORP Calibration Liquid (465 mV)</i>	30 €

MpH4 ve pH7 kalibrasyon sıvısı ve 465 mV ORP kalibrasyon sıvısından oluşur.
Consists of pH4 and pH7 calibration fluid and 465 mV ORP calibration fluid



PH Probu PH Probe

KOD CODE	TANIM DESCRIPTION	FİYAT PRICE
19818253021	6 mt Kablolu <i>6 mt Cable Lenght</i>	250 €
19818253022	1,5 mt Kablolu <i>1,5 mt Cable Lenght</i>	220 €

Epoksi gövde, 60°C'ye kadar çalışabilme özelliği.
Epoxy body, ability to work up to 60°C.

Dozaj Pompası Ekipmanları

Dosing Pumps Equipment



ORP Elektrotu ORP Electrode

KOD CODE	TANIM DESCRIPTION	FİYAT PRICE
19818253023	6 mt Kablolu 6 mt Cable Length	265 €
19818253024	1,5 mt Kablolu 1,5 mt Cable Length	235 €

Epoksi gövde, 60°C'ye kadar çalışabilme özelliği.
Epoxy body, ability to work up to 60°C.



Seviye Sensörü Level Sensor

KOD CODE	TANIM DESCRIPTION	FİYAT PRICE
19818253027	6 mt Kablolu 6 mt Cable Length	70 €

Karıştırma tankındaki kimyasalın seviyesini kontrol eden ve bittiğinde uyarı veren sensördür.
It is the sensor that controls the level of the chemical in the mixing tank and warns when it is finished.



Prob Tutucuları Probe Holder

KOD CODE	TANIM DESCRIPTION	FİYAT PRICE
19818253025	By-Pass Tip Hazneli Prob Tutucu (5" hazneli pislik tutucu ön filtre) Probe Holder with By-Pass type housing	140 €
19818253026	Hat Tip Prob Tutucu Probe Holder with Line Type	35 €



Klorinatör Chlorinator

KOD CODE	MODEL	BAĞLANTI mm CONNECTION mm	FİYAT PRICE
02099002419	Online 4 Kg	1 ½"	72 €
02099002420	Online 4 Kg	1 ½"	72 €

ABS plastik enjeksiyon gövde, 4 kg tablet kapasitesi, vanalı çıkış ile dozaj ayarı.
ABS plastic injection body, 4 kg tablet capacity, dosing adjustment via outlet valve.

Kimyasal Karıştırma Tankı Chemical Mixing Tank



KOD CODE	MODEL	KAPASİTE CAPACITY	FİYAT PRICE
15518002001	DD 100.A	100 lt	70 €
15518002002	DD 200.A	200 lt	110 €

Öne Çıkan Özellikler Product Features

- » Polietilenden üretilmiştir
- » Kimyasal maddelerin seyreltilip karıştırıldığı tanktır
- » Kimyasallara ve UV ışınlarına karşı dayanıklıdır
- » Made of polyethylene
- » It is a tank where the chemicals are diluted and mixed
- » Resistant to chemicals and UV rays

Motorlu Karıştırma Tankı Motorized Mixing Tank



KOD CODE	MODEL	KAPASİTE CAPACITY	FİYAT PRICE
15518002004	MK 100.A	100 lt	790 €
15518002005	MK 200.A	200 lt	865 €

Öne Çıkan Özellikler Product Features

- » Polietilenden üretilmiştir
- » Otomatik karıştırmayı sağlayacak motor
- » AISI 316 paslanmaz çelik pervane ve mili ile beraber teslim edilir
- » Made of polyethylene
- » Automatic mixing motor
- » Delivered with AISI 316 stainless steel impeller and shaft

Kimyasal Karıştırıcı Chemical Mixer



KOD CODE	ÜRÜN İSMİ PRODUCT NAME	FİYAT PRICE
164002024	Kimyasal karıştırıcı motoru 0,18 kw Mixer for tank chemical low rpm	--
164002018	Kimyasal karıştırıcı çubuk paslanmaz Chemical stirring rod stainless	--
KİM-KAR-ÇUBUK	Kimyasal karıştırıcı çubuk plastik Chemical stirring rod plastic	--

Dispenser



Mini model



72.D model

KOD CODE	MODEL	TABLET KAPASİTE TABLET CARRYING CAPACITY	FİYAT PRICE
15517123001	72.D	1 Kg	6.10 €
15517123002	Mini	200 Gr	4.00 €

Öne Çıkan Özellikler *Product Features*

- » ABS plastik enjeksiyondan üretilmiştir
- » Tablet klorun havuz suyuna kademeli verilmesini sağlar

- » Produced from ABS plastic injection
- » Provides gradual delivery of tablet chlorine to the pool water

Ayak Yıkama Teknesi *Foot Washing Basin*



KOD CODE	ÜRÜN ÖLÇÜLERİ Cm PRODUCT SIZES Cm	FİYAT PRICE
19818123007 (Plastik <i>Plastic</i>)	31x36	--
19818122003	48x31	60 €
19818122002	70x45	80 €

Öne Çıkan Özellikler *Product Features*

- » Polyesterden üretilmiştir
- » Kaydırmaz yüzeylidir
- » Plastikten üretilmiştir (Kod: 19818123007)

- » Made of polyester
- » Non-slip surface
- » Made of plastic (Code: 19818123007)

PH Otomatik Su Kalite Dedektörü *OH Automatic Water Quality Detector*



KOD CODE	ÜRÜN İSMİ PRODUCT NAME	FİYAT PRICE
15519223003	Kalem Tipi PH Ölçer <i>Pen Type Ph Meter</i>	20 €

Test Kitleri Test Kits

Öne Çıkan Özellikler Product Features

- » Havuz suyunun pH ve klor değerlerini ölçmek için kullanılır
- » Klor ve pH için 2 adet solüsyon içerir
- » Ölçüm aralığı: pH: 6.8- 8.2 / Ölçüm aralığı: Cl: 0.2- 1.0
- » Used to measure pH and chlorine values of pool water
- » Content of 2 solutions for chlorine and pH
- » Measuring range: pH: 6.8- 8.2 / Measuring range: Cl: 0.2- 1.0



KOD CODE	MODEL	FİYAT PRICE
15519123001	2'li Sıvılı 2 Way Liquid	9 €



KOD CODE	MODEL	MARKA BRAND	FİYAT PRICE
15519223001	Haplı With Tablet		13 €



KOD CODE	MODEL	FİYAT PRICE
15519123002	5'li Sıvılı 5 Way Liquid	15 €

Havuz suyunundaki pH, klor, brom, asid ihtiyacı ve toplam alkalinite değerlerini ölçmek için kullanılır, 6 ayrı solüsyon içerir.

It is used to measure pH, chlorine, bromine, acid demand and total alkalinity values in pool water, contains 6 different solutions.

Test Kağıdı Test Strips



KOD CODE	FİYAT PRICE
15519123005	10 €

Alüminyum folyo paketli, pH, alkalinite, sertlik ve klor ölçümü yapar.
Packed in aluminum foil, measures pH, alkalinity, hardness, and chlorine.

Test Kiti DPD1 ve Phenol Yedek Hapı Test Kit DPD1 and Phenol Tablets



KOD CODE	MODEL	FİYAT PRICE
TK-H-YED-DPD1	DPD1	1.50 €
TK-H-YED-PH	PHENOL	1.50 €

Öne Çıkan Özellikler Product Features

- » ADPD1: Klor ölçüm tableti
- » PHENOL: pH ölçüm tableti
- » 1 folyo = 10 tablet
- » DPD1: Chlorine test tablet
- » PHENOL: pH test tablet
- » 1 foil = 10 tablets

Test Kiti Yedek Sıvı Setleri Test Kit With Liquid Set



KOD CODE	MODEL	FİYAT PRICE
15519123009	2'li Oto ve Phenol Yedek Sıvısı Oto & Phenol Liquid 2 Line Set	5 €
15519123008	5'li Yedek Sıvı 5 Line Set	6 €

Öne Çıkan Özellikler Product Features

- » 2'li Set: pH ve klor ölçüm çözümü
- » 5'li Set: pH, klor, brom, asit ihtiyacı ve alkalinite ölçüm çözümü
- » 2-Pack: Solution for pH and chlorine testing
- » 5-Pack: Solution for pH, chlorine, bromine, acid demand, and alkalinity testing

Granül Tuz Granular Salt



KOD CODE	TANIM DESCRIPTION	AĞIRLIK WEIGHT	FİYAT PRICE
59915133012	Tuz Salt	25 kg	0,35 € / kg
59915133010	Tuz Tablet Tablet Salt	25 kg	0,40 € / kg

Öne Çıkan Özellikler Product Features

- » Su yumuşatma ve tuz klor jeneratörlerinde kullanılır
- » Used in water softening and salt chlorine generators





HAVUZ KİMYASALLARI POOL CHEMICALS

HAVUZ KİMYASAL ÜRÜNLERİ POOL CHEMICAL PRODUCT

*Havuz Suyunda Denge
Balance in Pool Water*

Berrak ve güvenli havuzlar.
Clear and safe pools.

**Havuz suyunda hijyen ve dengeyi sağlayan profesyonel kimyasal çözümler.
Doğru ürünler ile suyun berraklığı ve kullanıcı sağlığı korunur.**

*Professional chemical solutions ensuring hygiene and balance in pool water.
The right products maintain crystal clarity and safeguard user health.*

Gc 56 Granül Klor

Gc 56 Granular Chlorine



HIZLI VE ETKİLİ FAST AND EFFECTIVE

%56 ve %90 aktif klor içeren yüksek kaliteli granül klor. 20-40 mm tanecik boyutunda, profesyonel kullanıma yönelik 50 kg, 25 kg, 10 kg ve 5 kg ambalaj seçenekleriyle sunulur.

Granular chlorine with 56% and 90% active chlorine content. Available in 20-40 mm granule size and supplied in 50 kg, 25 kg, 10 kg, and 5 kg packaging options.



Öne Çıkan Özellikler Product Features

- » %56 yoğunlukta stabilize, granül şeklinde diklordur
- » Havuz suyunun dezenfeksiyonunda etkilidir, bakteri oluşumunu engeller
- » Havuzda hedef organizma; escherichia coli (kolibasi), hepatit virüsü vb. mikroorganizmalardır
- » pH değeri nötrdür
- » Organik kirlilikleri okside ederek yosun oluşumunu önler
- » Stabilizatör içerdiği için UV ışınları etkisi ile aktivite kaybı olmaz
- » It is stabilized at 56% density in the form of granules, dichlor
- » It is effective in disinfection of pool water, prevents the formation of bacteria
- » Target organism in the pool; Escherichia Coli (colibasi), Hepatitis virus etc. are microorganisms
- » pH value is neutral
- » Prevents algae by oxidizing organic impurities
- » As it contains a stabilizer, there is no loss of activity with the effect of UV rays

Ambalaj Seçenekleri Packaging Options

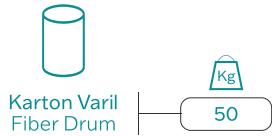

MSDS belgesine ulaşmak için QR kodu okutun.

Scan the QR code to access the MSDS document.



ŞOKLAMA AMAÇLI KULLANIM:

Her 100 m³ havuz suyu için 2-3 kg.

USE FOR SHOCK:

2-3 kg per 100 m³ pool water.

PERİYODİK KULLANIM:

Her 100 m³ havuz suyu için günde 200 gr - 300 gr kullanılır.

USE FOR PERIODIC:

200 gr - 300 gr per day is used for each 100 m³ pool water.



KOD CODE	AMBALAJ PACKING	FİYAT PRICE
54015133005	50	--
54015133014	25	---
54015133003	10	--
54015133002	5	--

Gc 90 Granül Klor

Gc 90 Granular Chlorine



HIZLI VE ETKİLİ FAST AND EFFECTIVE

%56 ve %90 aktif klor içeren yüksek kaliteli granül klor. 20-40 mm tanecik boyutunda, profesyonel kullanıma yönelik 50 kg, 25 kg, 10 kg ve 5 kg ambalaj seçenekleriyle sunulur.

Granular chlorine with 56% and 90% active chlorine content. Available in 20-40 mm granule size and supplied in 50 kg, 25 kg, 10 kg, and 5 kg packaging options.



Öne Çıkan Özellikler Product Features

- » Yavaş çözünen, sürekli ve şok dezenfeksiyon için stabilizatörlü, organik esaslı granül klor bileşimidir
- » Triklorozosyanürik asit (%90) aktif klor içerir
- » Stabilizatör içerdiği için UV ışınları etkisi ile aktivite kaybı olmaz
- » Havuz suyunun dezenfeksiyonunda etkilidir, bakteri oluşumunu engeller
- » Organik kirlilikleri okside ederek yosun oluşumunu önler
- » pH değeri nötrdür
- » Slowly dissolving, stabilizer and shock for continuous disinfection, organic chlorine-based compound granules
- » Trichlorisocyanuric acid (90%) contains active chlorine
- » As it contains a stabilizer, there is no loss of activity with the effect of UV rays
- » It is effective in disinfection of pool water, prevents bacterial growth
- » Prevents algae by oxidizing organic impurities
- » pH value is neutral

Ambalaj Seçenekleri Packaging Options



Plastik Kova
Plastic Drum



5 - 10 - 25



Karton Varil
Fiber Drum



50

MSDS belgesine ulaşmak için QR kodu okutun.

Scan the QR code to access the MSDS document.



ŞOKLAMA AMAÇLI KULLANIM:

Her 100 m³ havuz suyu için 2 kg.

USE FOR SHOCK:

2 kg for every 100 m³ of pool water.

PERİYODİK KULLANIM:

Her bir 100 m³ havuz suyu için günde 200 gr - 300 gr kullanılır.

USE FOR PERIODIC:

200 gr - 300 gr per day is used for each 100 m³ pool water.



KOD CODE	AMBALAJ PACKING	FİYAT PRICE
54015133010	50	--
54015133012	25	---
54015133008	10	--
54015133007	5	--

Ch 70 Kalsiyum Hipoklorid

Ch 70 Calcium Hypochlorite



KAPALI HAVUZLAR İÇİN ÖZEL DEZENFEKSİYON THE SECRET WEAPON OF INDOOR POOLS

Profesyonel granül yapı – %70 aktif klor
40 kg, 25 kg, 10 kg ve 5 kg'lık ambalaj alternatifleriyle.

Professional granular form – 70% active chlorine
Available in 40 kg, 25 kg, 10 kg, and 5 kg packaging options.



Granül
Granular



%70



Öne Çıkan Özellikler Product Features

- » Ca (ClO)₂ formülüne sahip inorganik bir bileşiktir
- » Suda yüksek oranda çözünür değildir ve daha tercihen yumuşak ila orta sertlikte suda kullanılır
- » Kalsiyum hipoklorit genel olarak yüzme havuzlarını ve içme suyunu dezenfekte etmek için kullanılır
- » Beyaz, granül, klor bazlı bir üründür
- » Legionella'ya karşı etkindir
- » Granül olduğu için kullanımı kolay ve pratiktir
- » Bağlı klor yükseldiğinde şoklama için idealdir

- » Inorganic compound with the formula Ca (ClO)₂
- » Not highly soluble in water and more preferably used in soft to medium hard water
- » Calcium hypochlorite is generally used to disinfect swimming pools and drinking water
- » It is a white, granular, chlorine based product
- » Active against Legionella
- » It is easy and practical to use because of granular
- » Ideal for shock when bound chlorine rises

Ambalaj Seçenekleri Packaging Options



Plastik Kova
Plastic Drum



5 - 10 - 25 - 40

MSDS belgesine ulaşmak için QR kodu okutun.

Scan the QR code to access the MSDS document.



ŞOKLAMA AMAÇLI KULLANIM:

Her 100 m³ havuz suyu için 2 kg.

USE FOR SHOCK:

2 kg per 100 m³ pool water.

PERİYODİK KULLANIM:

Her bir 100 m³ havuz suyu için günde 300 gr - 400 gr kullanılır.

USE FOR PERIODIC:

400 gr - 400 gr per day is used for each 100 m³ pool water.



KOD CODE	AMBALAJ PACKING	FİYAT PRICE
44002006	40	--
44002011	25	---
44002012	10	--
44002005	5	--

Tc 200 Triklor Tablet

Tc 200 Chlorine Tablet

SESSİZ KURTARICI

SILENT SAVIOR

200 g yavaş çözünen tablet form – Sürekli ve etkin dezenfeksiyon.

200 g tablet form, designed for long-lasting and efficient pool disinfection.



Tablet



%90



NETA HAVUZ
PRODUCT

Öne Çıkan Özellikler

Product Features

- » Yavaş çözünen, sürekli ve şok dezenfeksiyon için stabilizatörlü, organik esaslı granül klor bileşimidir
- » 200 gr tablet formundadır
- » Triklorizosiyanoik asit (%90) aktif klor içerir
- » Stabilizatör içerdiği için UV ışınları etkisi ile aktivite kaybı olmaz
- » Havuz suyunun dezenfeksiyonunda etkilidir
- » Organik kirlilikleri okside ederek yosun oluşumunu önler
- » Havuzda hedef organizma; escherichia coli(kolibasi), hepatit virüsü vb. mikroorganizmalardır.
- » pH değeri nötrdür

- » Slowly dissolving, stabilizer and shock for continuous disinfection, organic chlorine-based compound granules
- » It is in the form of 200 gr tablet
- » Trichloroisocyanuric acid (90%) contains active chlorine
- » As it contains a stabilizer, there is no loss of activity with the effect of UV rays
- » It is effective in disinfection of pool water
- » Prevents algae by oxidizing organic impurities
- » Target organism in the pool; escherichia coli (colibasi), hepatitis virus, etc. They are microorganisms
- » pH value is neutral

Ambalaj Seçenekleri

Packaging Options



Plastik Kova
Plastic Drum



5 - 10 - 25



Karton Varil
Fiber Drum



50

MSDS belgesine ulaşmak için QR kodu okutun.

Scan the QR code to access the MSDS document.



ŞOKLAMA AMAÇLI KULLANIM:

Her 100 m³ havuz suyu için 1 veya 3 tablet.

USE FOR SHOCK:

1 or 3 tablets per 100 m³ pool water.



KOD CODE	AMBALAJ PACKING	FİYAT PRICE
54016133004	50	--
54016133007	25	---
54016133002	10	--
54016133003	5	--

Mft Multifunctional Tablet

Mft Multifunctional Tablet

BÜTÜN BAKIM COMPLETE CARE

%90 aktif klor, yosun önleyici ve çöktürücü katkılı
200 g tablet form.

200 g tablets with 90% active chlorine, with algacide
and flocculant additives.



Tablet



%90



Öne Çıkan Özellikler Product Features

- » Yosun önleyici, çöktürücü ve %90 tablet klor içeren
200 gr'lık tabletler halindedir
- » Dezenfeksiyonu, yosun oluşumunun engellenmesini ve
partiküllerin dibe çökmesini sağlar
- » Kış bakım kimyasalı olarak da kullanılır

- » In the form of 200 gr tablets containing anti-algae, flocculant and
90% tablet chlorine
- » Its disinfection prevents the formation of algae and allows
the particles to settle to the bottom
- » Also used as a winter care chemical

Ambalaj Seçenekleri Packaging Options



Plastik Kova
Plastic Drum



5 - 10 - 20



Karton Varil
Fiber Drum



50

MSDS belgesine
ulaşmak için QR kodu
okutun.

Scan the QR code to
access the MSDS
document.



KULLANIM MİKTARI:

Her 100 m³ havuz suyu için haftalık 1-3 adet kullanılmalıdır.

USAGE AMOUNT:

1-3 pieces of tablets should be used weekly for every 100 m³ pool water.

KOD CODE	AMBALAJ PACKING	FİYAT PRICE
54022002001	50	--
54022002011	20	---
54022002002	10	--
54022002010	5	--

Pr Ph (-) Düşürücü Pr (-) Ph Reducer

HASSAS DENGELER PRECISE BALANCE

Havuz suyunda ideal pH dengesini sağlayan granül sodyum bisülfat. 25 kg torba, 10 kg ve 6 kg kova seçenekleriyle sunulur.

Granular sodium bisulfate for maintaining the ideal pH level in pool water. Available in 25 kg bags and 10 kg & 6 kg buckets.

Granül
Granular



Öne Çıkan Özellikler Product Features

- » İnorganik asitler ihtiva eden toz pH düşürücü kimyasaldır
- » Havuz suyunun pH değerinin 7,2 ila 7,6 ideal değerler getirmek için kullanılır

- » It is a powder pH reducing chemical containing inorganic acids
- » Used to bring the pH value of pool water to its ideal value in the range of 7.2 to 7.6

Ambalaj Seçenekleri Packaging Options

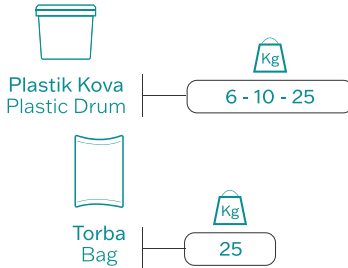

KULLANIM MİKTARI:

Açık havuzlarda ölçümler günlük klor ile birlikte pH değeri en az 2 kere ölçülmelidir. Havuz suyunun pH değerini 0.1 değer düşürmek için 100 m³ suyu 1 - 1,5 kg arasında kullanılmalıdır. Ürün doğrudan havuz suyuna uygulanır.

USAGE AMOUNT:

In open pools, the pH value should be measured at least 2 times with daily chlorine. To decrease the pH value of the pool water by 0.1 value, 100 m³ water should be used between 1 and 1.5 kg. The product is applied directly to the pool water.

MSDS belgesine ulaşmak için QR kodu okutun.



Scan the QR code to access the MSDS document.

KOD CODE	AMBALAJ PACKING	FİYAT PRICE
55015133001	25 Kova Drum	--
55015133004	25 PP Torba PP Back	---
55015133002	10	--
55015133003	6	--

Pr Ph (+) Yükseltici Pr (+) Ph Increaser

HASSAS DENGELER PRECISE BALANCE

Sodyum karbonat bazlı granül formu ile havuz suyunda pH seviyesini yükseltir. 10 kg ve 5 kg ambalaj seçenekleriyle sunulur.

Granular sodium carbonate formulation that raises the pH level in pool water. Available in 10 kg and 5 kg packaging options.

Granül
Granular



NETA HAVUZ
PRODUCT

Öne Çıkan Özellikler Product Features

» Havuz suyunun pH değerinin 7,2 ila 7,6 ideal değerler getirmek için kullanılır

» Used to bring the pH value of pool water to its ideal value in the range of 7.2 to 7.6

Ambalaj Seçenekleri Packaging Options



Plastik Kova
Plastic Drum

Kg

5 - 10

MSDS belgesine ulaşmak için QR kodu okutun.

Scan the QR code to access the MSDS document.



KULLANIM MİKTARI:

Havuzun çeşitli noktalarından eşit oranda havuz suyuna ilave edilir. Açık havuzlarda ölçümler günlük klor ile birlikte pH değeri en az 2 kere ölçülmelidir. Havuz suyu pH değerini 0.1 değer yükseltmek için 100 m³ suyuna 1-1,5 kg arasında kullanılmalıdır.

USAGE AMOUNT:

It is added to the pool water in equal proportion from various points of the pool. In open pools, the pH value should be measured at least 2 times with daily chlorine. To increase the pH value of the pool water by 0.1 value, it should be used between 1 and 1.5 kg per 100 m³ water.

KOD CODE	AMBALAJ PACKING	FİYAT PRICE
5016132002	5	--
55016132001	10	--

Lac Sıvı Yosun Önleyici

Lac Liquid Algaecide



YOSUNLA SAVAŞÇI

ALGAE FIGHTER

%4 DDAC formülüyle yosunlara karşı güçlü koruma. 5, 10 ve 20 litrelik seçenekleriyle her havuz için pratik çözüm.

Powerful algae protection with 4% DDAC formula. Practical solutions for every pool with 5, 10, and 20 liter options.



Sıvı
Liquid



Öne Çıkan Özellikler

Product Features

- » Havuz suyunda oluşmuş yosunlara karşı etkilidir
- » Dezenfeksiyon etkisi içermektedir
- » Etkili ve uzun süreli yok etme özelliğine sahiptir

- » Effective against algae formed in the pool water
- » Contains disinfection effect
- » Effective and long-term destruction feature

Ambalaj Seçenekleri

Packaging Options



Plastik Bidon
Plastic Drum



5 - 10 - 20

MSDS belgesine ulaşmak için QR kodu okutun.

Scan the QR code to access the MSDS document.



ŞOKLAMA AMAÇLI KULLANIM:

Her 100 m³ havuz suyu için 2 litre.

USE FOR SHOCK:

2 lt per 100 m³ pool water.

PERİYODİK KULLANIM:

Her 100 m³ havuz suyu için haftalık olarak 0,5-1,0 lt kullanılmalıdır.

USE FOR PERIODIC:

0,5-1,0 lt should be used weekly for every 100 m³ pool water.

KOD CODE	AMBALAJ PACKING	FİYAT PRICE
54017131001	20	--
54017131002	10	---
54017131003	5	--

Lb Sıvı Çökeltici

Lb Liquid Flocculant

SÜPÜRGENİN GÜCÜ

CLEANER'S POWER

PAC bazlı çökeltici formülüyle havuz suyunu berraklaştırır, süpürgenin işini kolaylaştırır. 5, 10 ve 20 litrelik ambalaj seçenekleriyle profesyonel kullanıma uygundur.

PAC-based formula clarifies pool water and supports your cleaner's performance. Available in 5, 10, and 20 liter packages for professional use.



Öne Çıkan Özellikler

Product Features

» Havuz filtresinin tutamadığı küçük partiküllerin toplanarak dibe çökmesini veya filtrede yakalanır hale gelmesini sağlayan kimyasaldır

» It is a chemical that causes small particles that the pool filter cannot hold to clump together and settle to the bottom or become trapped in the filter.

Ambalaj Seçenekleri

Packaging Options



Plastik Bidon
Plastic Drum



5 - 10 - 20

MSDS belgesine ulaşmak için QR kodu okutun.

Scan the QR code to access the MSDS document.



KULLANIM ŞEKLİ:

100 m³ havuz suyuna 1 litredir. Çökeltici uygulamasından sonra 30 dk çalıştırılıp gece dinlenmeye bırakılır. Sabah havuz, dip süpürgesi ile süpürülür.

USEGE:

1 liter for 100 m³ pool water. After the flocculant application, it is operated for 30 minutes and left to rest at night. In the morning, the pool is swept with a bottom broom.

PERİYODİK KULLANIM:

Her 100 m³ havuz suyu için 0,5-1,0 lt.

USE FOR PERIODIC:

0,5-1,0 lt for 100 m³ pool water.

KOD CODE	AMBALAJ PACKING	FİYAT PRICE
55018131001	20	--
55018131002	10	---
55018131003	5	--

Lb Sıvı Parlatici

Lb Liquid Brighener

BİR MİKTAR PARILTI ALGAE FIGHTER

Her damlada berrak bir ışık, her havuzda göz alıcı bir parlaklık. PAC ve DDAC formülüyle müşterilerinize profesyonel berraklığı yaşatın.

A sparkle in every drop, dazzling clarity in every pool. With the PAC and DDAC formula, let your customers experience professional brilliance.



Sıvı
Liquid



Öne Çıkan Özellikler Product Features

- » Yüzme havuzlarında, partiküler kirliliğin filtrelerde tutunmasını sağlayarak koloidal kirliliği giderir
- » Havuz suyunun temiz ve berrak kalmasını sağlar

- » It removes colloidal pollution in swimming pools by keeping the particulate pollution on the filters
- » It keeps the pool water clean and clear

Ambalaj Seçenekleri Packaging Options



Plastik Bidon
Plastic Drum



5 - 10 - 20

MSDS belgesine ulaşmak için QR kodu okutun.

Scan the QR code to access the MSDS document.



PERİYODİK KULLANIM:

Her 100 m³ havuz suyu haftada bir kez 0,5 lt uygulanır.

PERIODIC USAGE:

Every 100 m³ pool water is applied 0,5 liter once a week.

KOD CODE	AMBALAJ PACKING	FİYAT PRICE
55017131005	20	--
55017131002	10	---
55017131003	5	--

Sc Sıvı Yüzey Temizleyici

Sc Liquid Surface Cleaner



TEMİZ YÜZEY CLEAN SURFACE

Yüzeylerdeki kir ve kalıntıları etkili şekilde temizler, hijyen ve estetik görünüm kazandırır. Profesyonel temizlik için ideal çözümdür.

Effectively removes dirt and deposits from surfaces, ensuring hygiene and a clean look. The ideal solution for professional cleaning.



Sıvı
Liquid



Öne Çıkan Özellikler Product Features

- » İnorganik esaslı asit içerir
- » Havuz yüzeyleri ve diğer yüzeyler üzerinde birikmiş olan kireç ve mineral kir tabakasını temizler
- » Contains inorganic acid
- » It cleans the lime and mineral dirt layer accumulated on pool surfaces and other surfaces

Ambalaj Seçenekleri Packaging Options



Plastik Bidon
Plastic Drum



5 - 20



KULLANIM ŞEKLİ:

Havuz yüzey temizleyici, kireç birikintilerini temizlemek için 25'lik çözelti halinde uygulanır.

USAGE:

Pool surface cleaner is applied in the form of 25% solution to clean lime deposits.

KOD CODE	AMBALAJ PACKING	FİYAT PRICE
54021132002	20	--
54021132001	5	--



DOĞRU ETKİ

THE RIGHT IMPACT



DOĞRU TEMİZLİK

PROPER CLEANING

ISITMA VE NEM ALMA EKİPMANLARI HEATING & DEHUMIDIFIERS



HAVUZ ISITMA VE NEM ALMA ÜRÜNLERİ POOL HEATING AND DEHUMIDIFIERS PRODUCT

*Sıcaklıkta Süreklilik
Continuity in Temperature*

Verimli Isıtma Teknolojileri.
Efficient Heating Technologies.

Enerji tasarruflu çözümlerimiz, işletme maliyetlerini azaltırken yüksek performans sağlar. Uzun ömürlü ve güvenilir tasarımıyla projelerinizde fark yaratır.

Our energy-efficient solutions deliver high performance while reducing operating costs. Their long-lasting and reliable design makes a difference in your projects.

Electro Isıtıcı Seçim Tablosu

Electro Heater Selection Table

ELEGRO ENGINEERING	NANO SPA	FLOWLINE 2	EVOLUTION ANALOG	EVOLUTION DIGITAL	OPTIMA COMPACT	SFS JOEY DIGITAL	TITAN OPTIMA
KAPASİTE RANGE	1-8 kw	2-24 kw	6-24 kw	6-24 kw	2-18 kw	120 kw	18-120 kw
DİJİTAL TERMOSTAT DIGITAL THERMOSTAT	--	--	--	✓	--	✓	✓
KUMANDA PANOSU GEREKTİRMEZ NO CONTROL PANEL REQUIRED	✓	--	✓	✓	✓	✓	✓
AKIŞ SENSÖRÜ FLOW SWITCH	✓	✓	✓	✓	✓	✓	✓
DOKUNMATİK EKРАН TOUCH SCREEN	--	--	--	--	✓	--	✓
MONOFAZE SEÇENEĞİ MONOPHASE RANGE	1-6 kw	1-9 kw	1-18 kw	1-18 kw	1-18 kw	--	--
SIEMENS KONTAKTÖR SIEMENS CONTRACTOR	✓	--	✓	✓	✓	✓	✓



Nano Spa Model

SPA ÇÖZÜMLERİ SPA SOLUTIONS

Nano Spa, kompakt yapısıyla küçük havuz ve spa projelerine özel geliştirilmiştir. Profesyoneller için güvenli ve kolay kurulum avantajı sunar.

Nano Spa is specially designed with a compact structure for small pools and spa projects. It offers professionals the advantage of safe and easy installation.

 TUZLU SUDA KULLANILIR
USE IN SALT WATER

 SESSİZ
SILENT

 TİTANYUM ISITMA ELEMANI
TITANIUM HEATING ELEMENT



 **finder**
SWITCH TO THE FUTURE

Öne Çıkan Özellikler Product Features

- » Nano SPA Isıtıcı spalar için ideal bir çözümdür
- » 1 kW ila 8 kW arası boyutlarda mevcuttur
- » Kurulumu kolaydır
- » Kontaktör ve termostatı üzerindedir ve kabloludur
- » Sağlam, dayanıklı yapıya sahiptir
- » Ultra güvenilir akış şalteri sayesinde güvenle çalışır
- » Sıcaklık termostatı ve aşırı ısınma sensörü mevcuttur
- » Kompakt ve dayanıklı tasarıma sahiptir
- » 1,2°C hassasiyet ile analog kontrol sağlar
- » Zemin veya dikey olarak duvara monte edilebilir

- » Nano SPA heater is an ideal solution for spas
- » Available in sizes from 1 kW up to 8 kW
- » Easy installation
- » Fully equipped (including in the contactor and thermostat on it) and pre-wired
- » Robust, durable construction
- » Ultra-reliable flow switch allows safe operation
- » Supplied with temperature thermostat and overheating sens
- » Compact, durable design
- » Can be wall mounted on floor or vertically
- » No loss of efficiency throughout its working life

Montaj Şeması Installation Diagram

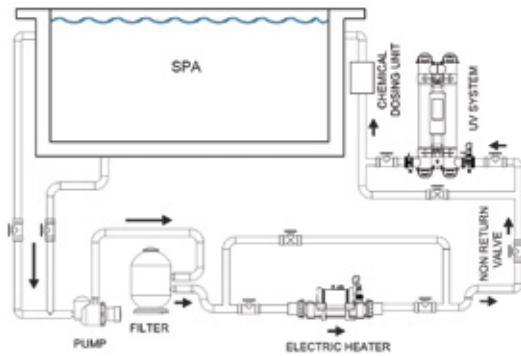

KOD CODE	GÜÇ POWER	FAZ PHASE	DEBİ İHTİYACI FLOW REQUIREMENTS		FİYAT PRICE
			min.	max.	
16015123106	1 kW	Monofaz Single phase	1 m³/h	17 m³/h	610 €
16015123111	2 kW	Monofaz Single phase	1 m³/h	17 m³/h	618 €
16015123112	3 kW	Monofaz Single phase	1 m³/h	17 m³/h	625 €
16015123110	4 kW	Monofaz Single phase	1 m³/h	17 m³/h	635 €
16015123109	5 kW	Monofaz Single phase	1 m³/h	17 m³/h	645 €
16015123108	6 kW	Monofaz Single phase	1 m³/h	17 m³/h	655 €
16015123083	8 kW	Trifaz Threephase 3 faz/phase 400V	1 m³/h	17 m³/h	670 €

Flowline 2

PROJEYE UYUM PROJECT FIT

Harici kontaktör bağlantısı ile esnek kurulum imkânı verir. Dayanıklı yapısıyla uzun ömürlü çözümler sunar.
Provides flexible installation with external contactor connection. Its robust construction ensures long-lasting solutions for professional use.

 TUZLU SUDA KULLANILIR
USE IN SALT WATER

 SESSİZ
SILENT

 Tİ
TİTANYUM ISITMA ELEMENTİ
TITANIUM HEATING ELEMENT



Öne Çıkan Özellikler Product Features

- » 2 kW ile 24 kW arasında değişen güç seçeneği
- » Kablolu değildir, harici kontaktöre bağlantı gerektirir
- » Sağlam, dayanıklı yapıya sahiptir
- » Kompakt ve dayanıklı tasarıma sahiptir
- » Ultra güvenilir akış şalteri sayesinde güvenle çalışır
- » Sıcaklık termostatu ve aşırı ısınma sensörü mevcuttur
- » 1,2°C hassasiyet ile analog kontrol sağlar
- » Zemin veya dikey olarak duvara monte edilebilir
- » Çalışma ömrü boyunca verim kaybına uğramaz
- » Power option ranging from 2 kW to 24 kW
- » Non-wired, requires connection to external contactor
- » Robust, durable construction
- » Compact, durable design
- » Ultra-reliable flow switch allows safe operation
- » Supplied with temperature thermostat and overheating sensor
- » Analogue control with 1.2°C differential
- » Can be wall mounted on floor or vertically
- » No loss of efficiency throughout its working life

Montaj Şeması Installation Diagram

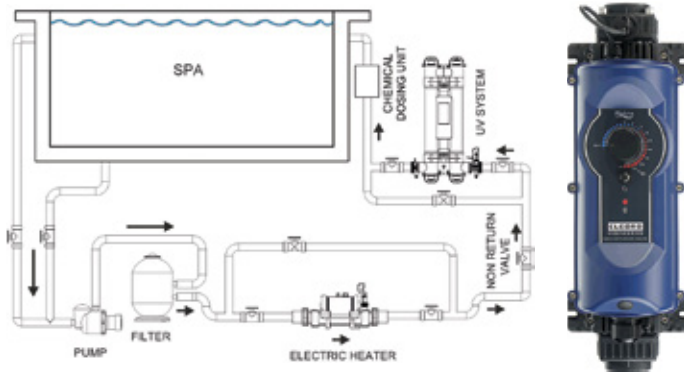

KOD CODE	GÜÇ POWER	FAZ PHASE	DEBİ İHTİYACI FLOW REQUIREMENTS		FİYAT PRICE
			min.	max.	
16015123090	6 kW	Monofaz Mono	1 m ³ /h	17 m ³ /h	605 €
16015123088	6 kW	Trifaz Threephase	4 m ³ /h	17 m ³ /h	690 €
16015123127	9 kW	Trifaz Threephase	4 m ³ /h	17 m ³ /h	705 €
16015123126	12 kW	Trifaz Threephase	4 m ³ /h	17 m ³ /h	715 €
16015123104	15 kW	Trifaz Threephase	4 m ³ /h	17 m ³ /h	730 €
16015123125	18 kW	Trifaz Threephase	4 m ³ /h	17 m ³ /h	750 €
16015123129	24 kW	Trifaz Threephase	4 m ³ /h	17 m ³ /h	775 €

Evolution 2

HAZIR DONANIM BUILT-IN CONTROL

Kontaktör ve termostatı üzerinde barındıran Evolution 2, kurulum kolaylığı ile öne çıkar. Profesyonel havuz projelerinde güvenli ve uzun ömürlü bir ısıtma çözümü sunar.

Equipped with its own contactor and thermostat, Evolution 2 stands out with easy installation. It delivers a safe and long-lasting heating solution for professional pool projects.

TUZLU SUDA KULLANILIR
USE IN SALT WATER

SESSİZ
SILENT

TİTANYUM ISITMA ELEMANI
TITANIUM HEATING ELEMENT



SIEMENS
Contactor

Öne Çıkan Özellikler Product Features

- » 6 kW ile 24 kW arasında değişen güç seçeneği
- » Kurulumu kolaydır
- » Kontaktör ve termostatı üzerindedir ve kabloludur
- » Sağlam, dayanıklı yapıya sahiptir
- » Kompakt ve dayanıklı tasarıma sahiptir
- » Ultra güvenilir akış şalteri sayesinde güvenle çalışır
- » Sıcaklık termostatı ve aşırı ısınma sensörü mevcuttur
- » 1,2°C hassasiyet ile analog kontrol sağlar
- » Çalışma ömrü boyunca verim kaybına uğramaz

- » Power option ranging from 6 kW to 24 kW
- » Easy installation
- » Fully equipped (Including in the contactor and thermostat on it) and pre-wired
- » Robust, durable construction
- » Compact, durable design
- » Ultra-reliable flow switch allows safe operation
- » Supplied with temperature thermostat and overheating sensor
- » Analogue control with 1.2°C differential
- » No loss of efficiency throughout its working life

Montaj Şeması Installation Diagram

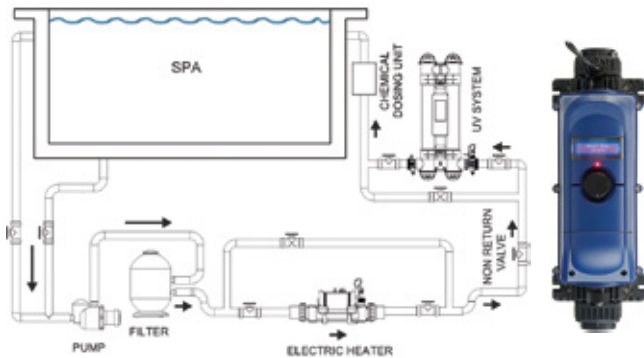

Ölçüler Dimensions

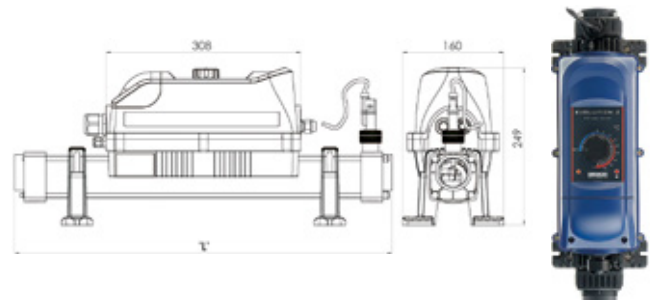

KOD CODE	GÜÇ POWER	FAZ PHASE	DEBİ İHTİYACI FLOW REQUIREMENTS		FİYAT PRICE
			min.	max.	
16015123117	6 kW	Mono / Tri	1 m³/h	17 m³/h	1.065 €
16015123124	9 kW	Mono / Tri	4 m³/h	17 m³/h	1.080 €
16015123123	12 kW	Mono / Tri	4 m³/h	17 m³/h	1.095 €
16015123113	15 kW	Trifaz Threephase	4 m³/h	17 m³/h	1.105 €
16015123122	18 kW	Trifaz Threephase	4 m³/h	17 m³/h	1.230 €
16015123121	24 kW	Trifaz Threephase	4 m³/h	17 m³/h	1.280 €

Optima Compact

ÇIFTE GÜVENLİK DUAL SAFETY

İki Siemens kontaktör ile güvenilir koruma sağlar. Dokunmatik ekranlı dijital termostat ile hassas ısı kontrolü sunar.

Provides reliable protection with two Siemens contactors. Delivers precise temperature control via digital touch screen thermostat.

TUZLU SUDA KULLANILIR
USE IN SALT WATER

SESSİZ
SILENT

TİTANYUM ISITMA ELEMENTİ
TITANIUM HEATING ELEMENT

WIFI KONTROL
WIFI CONTROL



SIEMENS
Contactor

Öne Çıkan Özellikler Product Features

- » 2 kW ile 24 kW arasında değişen güç seçeneği
- » Kontaktör ve termostatı üzerindedir ve kablodur
- » Sağlam, dayanıklı yapıya sahiptir
- » Kompakt ve dayanıklı tasarıma sahiptir
- » Ultra güvenilir akış şalteri sayesinde güvenle çalışır
- » Dijital sıcaklık termostatı ve aşırı ısınma sensörü mevcuttur
- » Dokunmatik ekran denetleyicisi dijital termostat 0,5°C diferansiyel
- » Çalışma ömrü boyunca verim kaybına uğramaz
- » 2 adet Siemens kontaktörü içerir (çifte güvenlik)

- » Power option ranging from 2 kW to 24 kW
- » Fully equipped (Including in the contactor and thermostat on it) and pre-wired
- » Robust, durable construction
- » Compact, durable design
- » Ultra-reliable flow switch allows safe operation
- » Supplied with digital temperature thermostat and overheating sensor
- » Touch screen controller digital thermostat 0.5°C differential
- » No loss of efficiency throughout its working life
- » Includes 2x Siemens contractors (double safety)

Montaj Şeması Installation Diagram

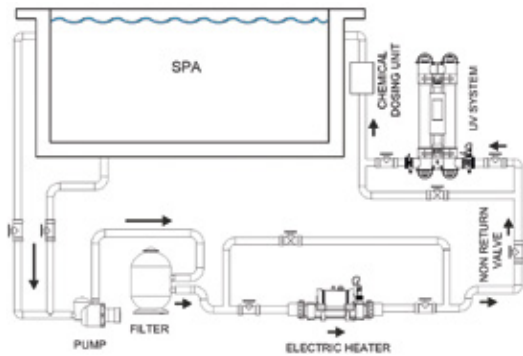

Ölçüler Dimensions

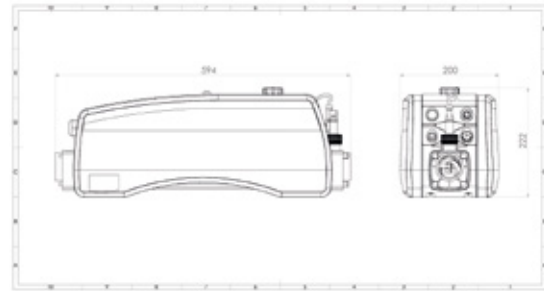

KOD CODE	GÜÇ POWER	FAZ PHASE	DEBİ İHTİYACI FLOW REQUIREMENTS		FİYAT PRICE
			min.	max.	
16015123079	6 kW	Mono / Tri	1 m³/h	17 m³/h	--
16015123080	9 kW	Mono / Tri	4 m³/h	17 m³/h	--
16015123078	12 kW	Mono / Tri	4 m³/h	17 m³/h	--
16015123077	15 kW	Trifaz Threephase	4 m³/h	17 m³/h	--
16015123076	18 kW	Trifaz Threephase	4 m³/h	17 m³/h	--
16015123075	24 kW	Trifaz Threephase	4 m³/h	17 m³/h	--

Sfs Joey

TİCARİ GÜÇ COMMERCIAL POWER

18-120 kW aralığıyla büyük ölçekli projeler için idealdir. Dayanıklı yapısı ve çift Siemens kontaktör ile uzun ömürlü güvenlik sunar.

Ideal for large-scale projects with a power range from 18 to 120 kW. Its robust design and dual Siemens contactors ensure long-term safety.

TİCARİ HAVUZ
COMMERCIAL POOL

TUZLU SUDA KULLANILIR
USE IN SALT WATER

TİTANYUM ISITMA ELEMENTİ
TITANIUM HEATING ELEMENT



Öne Çıkan Özellikler Product Features

- » 18 kW ile 120 kW arasında değişen güç seçeneği
- » Kurulumu kolaydır
- » Sağlam, dayanıklı yapıya sahiptir
- » Kompakt ve dayanıklı tasarıma sahiptir
- » Ultra güvenilir akış şalteri sayesinde güvenle çalışır
- » Çalışma ömrü boyunca verim kaybına uğramaz
- » Zemin veya dikey olarak duvara monte edilebilir
- » 2 adet Siemens kontaktörü içerir (çifte güvenlik)
- » Power option ranging from 12 kW to 120 kW
- » Easy installation
- » Robust, durable construction
- » Compact, durable design
- » Ultra-reliable flow switch allows safe operation
- » No loss of efficiency throughout its working life
- » Can be wall mounted on floor or vertically
- » Includes 2x Siemens contractors (double safety)

Montaj Şeması Installation Diagram

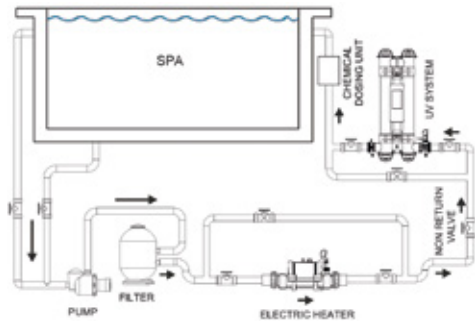

Ölçüler Dimensions

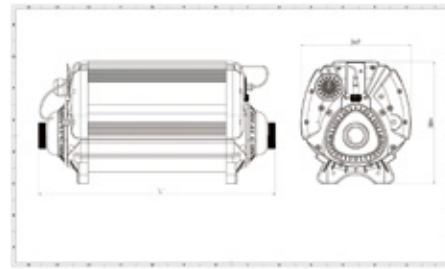

Çalışma videosunu
izlemek için QR kodu
okutun.

Scan the QR code to
watch the working video.



KOD CODE	GÜÇ POWER	FAZ PHASE	DEBİ İHTİYACI FLOW REQUIREMENTS		FİYAT PRICE
			min.	max.	
16015123065	18 kW	Trifaz Threephase	7 m ³ /h	15 m ³ /h	2.870 €
16015123066	24 kW	Trifaz Threephase	7 m ³ /h	15 m ³ /h	2.930 €
16015123067	30 kW	Trifaz Threephase	7 m ³ /h	15 m ³ /h	3.000 €
16015123068	36 kW	Trifaz Threephase	7 m ³ /h	15 m ³ /h	3.650 €
16015123069	45 kW	Trifaz Threephase	7 m ³ /h	15 m ³ /h	3.680 €
16015123070	54 kW	Trifaz Threephase	7 m ³ /h	15 m ³ /h	3.840 €
16015123071	60 kW	Trifaz Threephase	7 m ³ /h	15 m ³ /h	4.025 €
16015123072	72 kW	Trifaz Threephase	7 m ³ /h	15 m ³ /h	4.990 €
16015123073	96 kW	Trifaz Threephase	7 m ³ /h	15 m ³ /h	6.500 €
16015123074	120 kW	Trifaz Threephase	7 m ³ /h	15 m ³ /h	7.800 €

Titan Optima

TİTAN GÜCÜ TITAN POWER

120 kW'a kadar geniş güç kapasitesiyle büyük ölçekli havuz projelerinde maksimum performans sağlar.

It provides maximum performance in large-scale pool projects with its large power capacity of up to 120 kW.

TUZLU SUDA KULLANILIR
USE IN SALT WATER

Ti
TİTANYUM ISITMA ELEMANI
TITANIUM HEATING ELEMENT



MAX.
4 BAR

SIEMENS
Contactor

Öne Çıkan Özellikler Product Features

- » 18 kW ile 120 kW arasında değişen güç seçeneği
- » Kurulumu kolaydır
- » Kontaktör ve termostatı üzerindedir ve kabloludur
- » Sağlam, dayanıklı yapıya sahiptir
- » Kompakt ve dayanıklı tasarıma sahiptir
- » Ultra güvenilir akış şalteri sayesinde güvenle çalışır
- » Dijital sıcaklık termostatı ve aşırı ısınma sensörü mevcuttur
- » Çalışma ömrü boyunca verim kaybına uğramaz
- » Zemin veya dikey olarak duvara monte edilebilir
- » 2 adet Siemens kontaktörü içerir (çifte güvenlik)

- » Power option ranging from 18 kW to 120 kW
- » Easy installation
- » Fully equipped (Including in the contactor and thermostat on it) and pre-wired
- » Robust, durable construction
- » Compact, durable design
- » Ultra-reliable flow switch allows safe operation
- » Supplied with digital temperature thermostat and overheating sensor
- » No loss of efficiency throughout its working life
- » Can be wall mounted on floor or vertically
- » Includes 2x Siemens contractors (double safety)

Montaj Şeması Installation Diagram

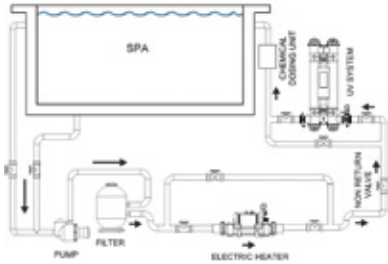

Ölçüler Dimensions

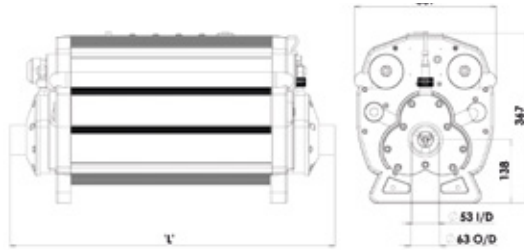

KOD CODE	GÜÇ POWER	FAZ PHASE	DEBİ İHTİYACI FLOW REQUIREMENTS		FİYAT PRICE
			min.	max.	
16015123082	18 kW	Trifaz Threephase	12 m³/h	45 m³/h	3.500 €
16015123081	24 kW	Trifaz Threephase	12 m³/h	45 m³/h	3.550 €
16015123119	30 kW	Trifaz Threephase	12 m³/h	45 m³/h	3.610 €
16015123107	36 kW	Trifaz Threephase	12 m³/h	45 m³/h	4.350 €
16015123120	45 kW	Trifaz Threephase	12 m³/h	45 m³/h	4.500 €
16015123091	54 kW	Trifaz Threephase	12 m³/h	45 m³/h	4.650 €
16015123114	60 kW	Trifaz Threephase	12 m³/h	45 m³/h	4.850 €
16015123118	72 kW	Trifaz Threephase	12 m³/h	45 m³/h	5.900 €
16015123097	96 kW	Trifaz Threephase	12 m³/h	45 m³/h	7.550 €
16015123115	120 kW	Trifaz Threephase	12 m³/h	45 m³/h	9.330 €



Isıtıcı Heater	Havuz Tipi For Pool Type					Model No No of Models	Güç Çıkışı Power Output (kW)	Fiş Dahil Plug Included	Titanyum Isıtma Elemanı Titanium Heating Element	Titanyum Akış Tüpü Titanium Flow Tube	Analog Kontrol Analogue Control	Dijital Kontrol Digital Control	Dokunmatik Ekran/ Programlanabilir Touch Screen/ Programmable	Deniz ve Tuz Klorlu Suya Uygun Sea & Salt Chlorinated Water Safe	Duvara ve Zeminde Monte Edilebilir Wall & Floor Mountable
	Spa	Yer Üstü Above-Ground	Ev Tipi Residential	Ev Tipi Commercial	Su Sporları Aquatics*										
Nano Spa	●					11	1 - 8		●	●	●			●	●
Nano Splasher		●				7	1 - 3	●	●	●	●			●	●
Flowline 2	●	●	●			20	1 - 24		●	●	●			●	●
Evolution 2	●	●	●			23	1 - 24		●	●	●	●		●	●
Optima Compact	●	●	●			23	1 - 24		●	●			●	●	●
SFS Joey				●		19	18 - 120		●	●	●			●	●
Titan Optima				●		19	18 - 120		●	●			●	●	●
Nano Cygnet					●	7	1 - 4	▲	●	●	●			●	●
Evolution 2 Cygnet					●	11	1 - 84		●	●	●			●	●

* Su bitkileri göletleri ve büyük akvaryumları ifade eder Aquatics refers to ponds and large aquariums ▲ Nano Cygnet 4kW - Fiş dahil değildir Nano Cygnet 4kW - No plug included

Kontrolör Controller	Isıtıcı Heating	Soğutucu Cooling	Analog Analogue	Dokunmatik Ekran Programlanabilir Touch Screen Programmable	Elektrikli Isıtıcı/Isı Eşanjörü Uyumluluğu Electric Heater/Heat Exchanger Compatibility										Akış Sensörleri Portları Flow Sensor Ports	Sıcaklık Sensörleri Portları Temp Sensor Ports	Çok Dilli Arayüz Multi-lingual Interface	İsteğe bağlı Grupos Takviye Pompası Optional Grupos Booster Pump
					All Nano Models	Flowline 2	Evo 2	Optima Compact	SFS Joey	Titan Optima	G2	SST	Escalade	Plate				
Poolsmart Plus	●			●	●	●	●	●	●	●	●	●	●	●	●	●	●	

SİSTEM KURULUMU SYSTEM SETUP

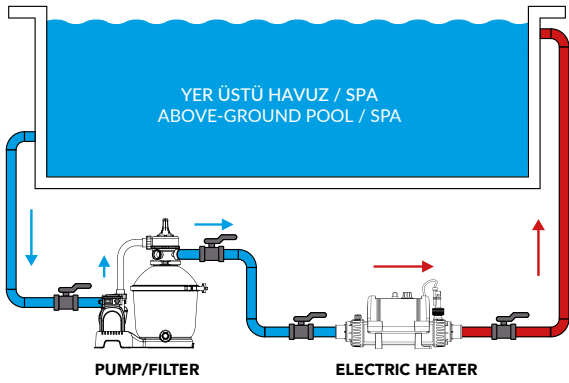

Yer üstü havuza veya spaya bağlanma
Connecting to an above-ground pool or spa

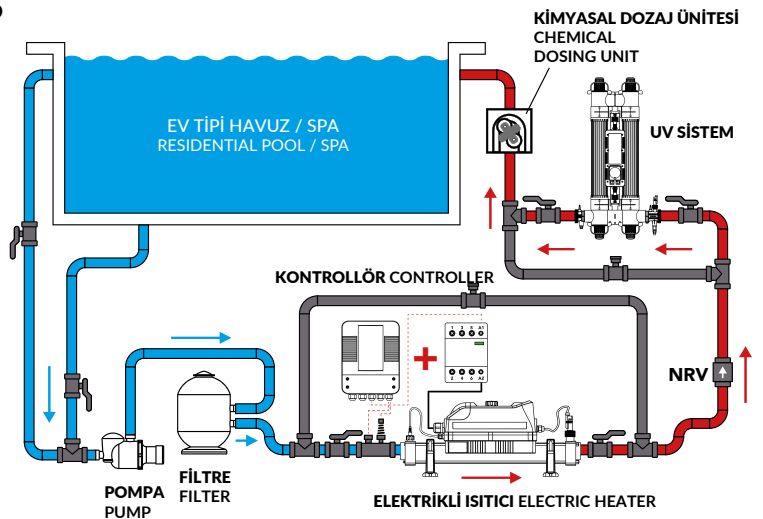

Konut havuzuna veya spaya bağlanma
Connecting to a residential pool or spa

Borulu Isı Eşanjörü

G2 Multi Tubular

TİTANYUM TÜPLER

TITANIUM TUBES

37 titanyum tüp yapısıyla yüksek verimlilik ve uzun ömür sunar. Tuzlu suya dayanıklı tasarımıyla profesyonel projeler için güvenilir çözümdür.

Built with 37 titanium tubes for efficiency and durability. Saltwater-resistant design makes it a reliable choice for professional projects.

TUZLU SUDA KULLANILIR
USE IN SALT WATER

WIFI KONTROL
WIFI CONTROL



Öne Çıkan Özellikler

Product Features

- » 22 kW ile 122 kW arasında değişen güç seçeneği
- » 37 Titanyum tüpten yapılmış ikincil devre
- » BS 316L paslanmaz çelik ana kasa
- » 4 bar basınç toleransı, basınç kaybı düşüktür
- » Uzaktan kumanda (Wifi Uygulaması) ile isteğe bağlı akıllı dokunmatik ekran denetleyicisi eklenebilir
- » Sıcaklık ve akış sensörü bağlantı noktası mevcuttur
- » Zemine veya dikey olarak duvara monte edilebilir
- » Tuzdan klor cihazıyla uyumlu
- » Variable power option between 22 kW and 122 kW
- » Secondary circuit made of 37 Titanium tubes
- » BS 316L stainless steel primary casing
- » 4 bar pressure tolerance, pressure loss is low
- » Optional smart touch screen controller can be added with remote controle (Wifi App)
- » Temperature and flow sensor connection point is available
- » Can be wall mounted on floor or vertically
- » Compatible with salt chlorinator

Ölçüler Dimensions

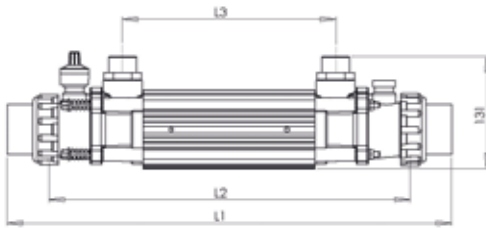

Electro G2 Isı Eşanjörü Ebatları $\Delta T 30^\circ C$ Rehberi Electro G2 Heat Exchanger Sizing Guide for $\Delta T 30^\circ C$

İSTENİLEN SICAKLIK DESIRED TEMPERATURE [°C]	Isıtma Süresi Heating Time [HRS]	Havuz Hacmi Pool Volume [m³]																	
		5	10	15	20	25	30	35	40	45	50	55	60	65	70	75	80	85	90
28	48	30kW					49kW					85kW					122kW		
30		30kW					49kW					85kW					122kW		
32		30kW					49kW					85kW					122kW		
34		30kW					49kW					85kW					122kW		
36		30kW					49kW					85kW					122kW		
38		30kW					49kW					85kW					122kW		
40		30kW					49kW					85kW					122kW		

KOD CODE	GÜÇ POWER	BAĞLANTI CONNECTION	FİYAT PRICE
16016123007	30 kW	50 mm	530 €
16016123008	49 kW	50 mm	655 €
16016123010	85 kW	50 mm	805 €
16016123011	122 kW	50 mm	1.120 €

Heatsmart & Koolsmart

AKILLI KONTROL SMART CONTROL

Dokunmatik ekran ve Bina Yönetim Sistemi entegrasyonu ile profesyonel projelerde tam denetim sağlar. Akış ve sıcaklık sensörleriyle hassas kontrol imkânı sunar.

With touch screen and Building Management System integration, it provides full control in professional projects. Flow and temperature sensors enable precise regulation.

 DOKUNMATİK EKLAN
WITH TOUCH SCREEN

 HATA GÖSTERGESİ
DIAGNOSTIC DISPLAY



Öne Çıkan Özellikler Product Features

- » BMS (Bina Yönetim Sistemi) entegrasyonuna hazır
- » Çok dilli arayüz
- » Programlanabilir 24 saatlik zaman saati (4 zaman dilimi)
- » Akış ve sıcaklık sensörü portları
- » 0,5°C'ye kadar hassas kontrol
- » Dijital termostatlı
- » Isı eşanjörü ortamınızı kontrol eder
- » Kullanıcı dostu bir interfaz sağlar
- » 1 metre uzunluğunda akış anahtarı ve 1 metre sıcaklık sensörü içerir
- » Dokunmatik ekran denetleyicisi ve dijital ekran
- » Isıtma kaynağını kontrol etmek için voltsuz çıkış (kazan)
- » Sirkülasyon pompasını kontrol etmek için 220-240 Volt çıkış
- » BMS (Building Management System) integration ready
- » Multi-lingual interface
- » Programmable 24-hour time clock. (4 time zones)
- » Flow and temperature sensor ports
- » Accurate control to 0.5°C
- » With digital thermostat
- » Control your heat exchanger environment
- » Offer a user friendly interface
- » Includes 1 meter long flow switch & 1 meter long temperature sensor
- » Touch screen controller & digital display
- » Volt free output to control source of heating (boiler)
- » 220-240 Volt output to control circulation pump

Ölçüler Dimensions

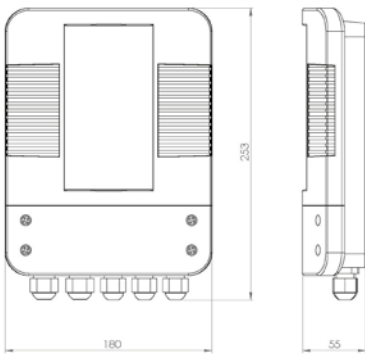

PAKET 1 PACKAGE 1

PSPC-HE

Heatsmart + Akış Anahtarı + sıcaklık sensörü içerir.
It includes Heatsmart + Flow Switch + temperature sensor.

PAKET 2 PACKAGE 2

PSPC-HE-GP

Heatsmart + Akış Anahtarı + sıcaklık sensörü + Grundfos sirkülasyon pompası içerir.
It includes Heatsmart + Flow Switch + temperature sensor + Grundfos circulation pump.

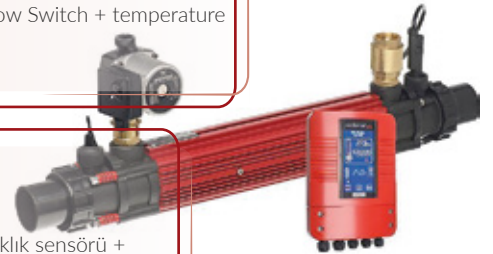

KOD CODE	MODEL	FREKANS FREQUENCY	GÜÇ POWER	FİYAT PRICE
16016123013	Heatsmart	50/60 hz	100-240 kW	1.690 €
16016123020	Koolsmart	50/60 hz	100-240 kW	935 €

G2C Isı Eşanjörü

G2C Heat Exchanger

TURBULANS VERİMLİLİĞİ

TURBULENCE EFFICIENCY

Twisted titanium tüp demeti sayesinde yüksek ısı transferi ve düşük basınç kaybı sunar. Geniş güç aralığıyla ticari havuz projelerinde maksimum verim sağlar..

Thanks to its twisted titanium tube bundle, it delivers high heat transfer and low pressure loss. Its wide capacity range offers maximum efficiency for commercial pool applications.

TİCARİ HAVUZ
COMMERCIAL POOL

TUZLU SUDA KULLANILIR
USE IN SALT WATER



Öne Çıkan Özellikler

Product Features

- » 170–320 kW geniş kapasite aralığı
- » CFD analizine göre optimize edilmiş tasarım
- » Grade 1 twisted titanium tüp demeti
- » Yüksek ısı transfer katsayısı, düşük işletme maliyeti
- » Tuzlu su ve deniz suyu kullanımına uygun
- » 4 bar çalışma basıncı toleransı
- » Yüksek debilerde düşük basınç kaybı
- » Kompakt tasarım, küçük alanlarda yüksek verim
- » Sıcaklık ve akış sensör bağlantı noktaları
- » Kontrol ünitesi entegrasyonuna hazır
- » Glikol karışımı soğutma uygulamalarıyla uyumlu
- » Zemin veya duvar montajına uygun
- » Wide capacity range from 170 to 320 kW
- » CFD-optimised engineering design
- » Grade 1 twisted titanium tube bundle
- » High heat transfer with reduced operating costs
- » Suitable for seawater and marine applications
- » 4-bar working pressure tolerance
- » Reduced pressure drops at high flow rates
- » Compact footprint with improved thermal performance
- » Temperature and flow sensor ports
- » Optional controller integration
- » Compatible with water-glycol cooling applications
- » Floor or wall mountable

Ölçüler Dimensions

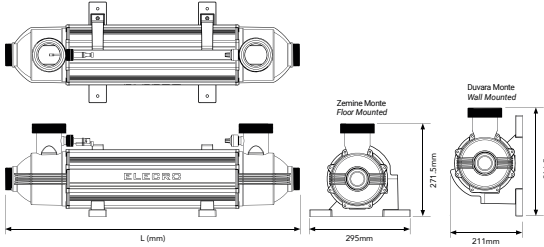

Basınç Düşüşü Pressure Drop

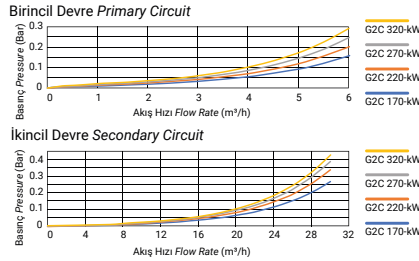

Ana Özellikler Key Features

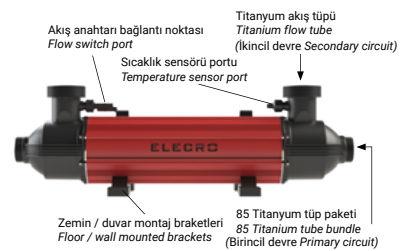

KOD CODE	MODEL	L (mm)	PRİMER DEBİ PRIMARY FLOW	PRİMER BA-SINÇ KAYBI LOSS (kPa)	SEKONDER DEBİ SECONDARY FLOW	SEKONDER BASINÇ KAYBI LOSS (KPA)	ΔT 15°C (kW)	ΔT 30°C (kW)	ΔT 65°C (kW)	FİYAT PRICE
16016123012	G2C-HE-170T	560	10 m³/h	12	28 m³/h	20	32	69	170	2.290 €
16016123014	G2C-HE-220T	710	10 m³/h	16	28 m³/h	26	42	91	220	2.550 €
16016123015	G2C-HE-270T	860	10 m³/h	20	28 m³/h	30	56	117	270	3.220 €
16016123016	G2C-HE-320T	960	10 m³/h	23	28 m³/h	32	65	136	320	3.750 €

Pool Smart Plus

HASSAS KONTROL PRECISE CONTROL

Bina Yönetim Sistemi entegrasyonuna hazır yapısıyla profesyonel tesislerde tam denetim sağlar. 0,5°C hassasiyetle sıcaklık kontrolü sunar.

Ready for Building Management System integration, it ensures full oversight in professional facilities. Provides temperature regulation with 0.5°C accuracy.

 DOKUNMATİK EKİRAN
WITH TOUCH SCREEN

 HATA GÖSTERGESİ
DIAGNOSTIC DISPLAY

 WIFI KONTROL
WIFI CONTROL



Öne Çıkan Özellikler Product Features

- » BMS (Bina Yönetim Sistemi) entegrasyonuna hazır
- » Çok dilli arayüz
- » Programlanabilir 24 saatlik zaman saati. (4 zaman dilimi)
- » 0,5°C'ye kadar hassas kontrol
- » Dijital termostatlı
- » WiFi üzerinden ısıtıcı kontrolü (uzaktan erişim)
- » 1 Faz, 100–240V / 50–60Hz çalışma aralığı
- » 3 metre akış anahtarı ve 3 metre sıcaklık sensörü ile birlikte gelir
- » T-parça bağlantı kiti ürünle birlikte sunulur
- » BMS (Building Management System) integration ready
- » Multi-lingual interface
- » Programmable 24-hour time clock. (4 time zones)
- » Accurate control to 0.5°C
- » With digital thermostat
- » WiFi heating control with remote access
- » Operates on 1-Phase, 100–240V / 50–60Hz
- » Supplied with 3m flow switch and 3m temperature sensor
- » Includes T-piece connection kit

Ölçüler Dimensions

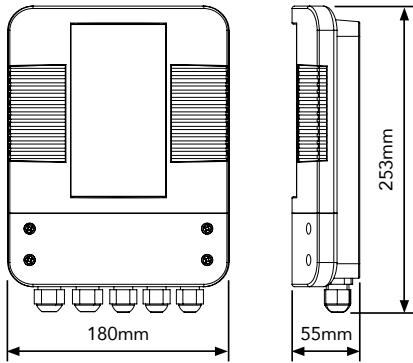

Aksesuarları Dahildir Accessories Included



KOD CODE	GÜÇ ÇIKIŞI POWER OUTPUT	AKSESUARLAR (DAHİLDİR) ACCESSORIES (INCLUDED)	AĞIRLIK GROSS WEIGHT	HACİM VOLUME
16015123055	Voltajsız ısıtma çıkışı ve voltajsız filtrasyon pompası çıkışı <i>Volt free heating output and volt free filtration pump output</i>	3 m uzunluğunda akış anahtarı, 3 m uzunluğunda sıcaklık sensörü, T parçası ve 50 mm ve 1,5" Redüktörler <i>3m long flow switch, 3m long temperature sensor, T-piece and 50mm & 1.5" Reducers</i>	1.450 kg	0.020 m ³

Boru Tipi Eşanjörü

Pipe Heat Exchanger

6 KAT VERİM

6x EFFICIENCY

Geleneksel eşanjörlere kıyasla 6 kata kadar daha yüksek verim sunar. Kompakt yapısı ve titanyum malzemesiyle uzun ömürlüdür.

Delivers up to six times higher efficiency compared to conventional heat exchangers. Its compact design and titanium construction ensure long-lasting durability.

Ti
TİTANYUM ISITMA ELEMANI
TITANIUM HEATING ELEMENT

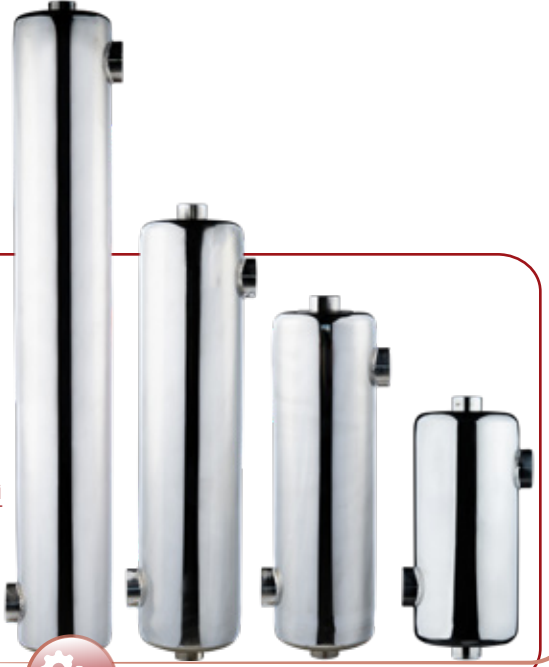

Öne Çıkan Özellikler

Product Features

- » Yüksek verim katsayısı 10000 W/m 2°C, geleneksel eşanjörlerden 5 ya da 6 kat daha fazla verimlilik
- » Kompakt dizaynı geleneksel ürünlere göre 1/10 oranındadır
- » Paslanmaz çelik ve/veya titanyum malzeme korozyon ve basınç faktörlerinde dayanıklılık sağlar
- » Eşanjörün bağlantı tasarımı, üzerindeki baskıyı yok eder
- » ASME Standardları VIII-1 ile uygunluk
- » Kompakt dizayn
- » Kolay montaj ve dayanıklılık
- » High efficiency coefficient 10000 W/m 2°C, 5 or 6 times more efficient than conventional heat exchangers
- » Compact design 1/10 of conventional products
- » Stainless steel and/or titanium material ensures resistance to corrosion and pressure factors
- » The connection design of the heat exchanger eliminates pressure on it
- » Compliance with ASME Standards VIII-1
- » Compact design
- » Easy installation and durability

Paslanmaz Kelepçe
Dayanıklı ve korozyona karşı güvenli bağlantı sağlar.

Stainless Clamp
Ensures durable, corrosion-resistant connection.



KOD CODE	GÜÇ POWER	SICAK SU AKIŞI HOT WATER FLOW	HAVUZUN SUYUNUN AKIŞI FLOW OF POOL WATER	FİYAT PRICE
16017124001	24 kW	18 L/Min	150 L/Min	212 €
16017124002	40 kW	25 L/Min	200 L/Min	234 €
16017124003	65 kW	30 L/Min	250 L/Min	250 €
16017124004	75 kW	35 L/Min	300 L/Min	272 €
16017124005	120 kW	50 L/Min	360 L/Min	368 €

Plakalı Eşanjör

Plate Heat Exchanger

PLAKA VERİMLİLİĞİ

PLATE EFFICIENCY

AISI 316 paslanmaz çelik plakalarıyla yüksek ısı transferi sağlar. Montaja hazır tasarımıyla profesyonel projelerde kolay kurulum imkânı sunar.

Provides high heat transfer with AISI 316 stainless steel plates. Ready-to-install design ensures easy setup in professional projects.

AISI
316
PASLANMAZ ÇELİK PLAKA
STAINLESS STEEL PLATE



Öne Çıkan Özellikler

Product Features

- » AISI 316 L paslanmaz çelik plakalıdır
- » Çok dilli arayüz
- » Programlanabilir 24 saatlik zaman saati (4 zaman dilimi)
- » 0,5°C'ye kadar hassas kontrol
- » Dijital termostatlı
- » Montaja hazır şekilde eşanjör saplamaları ve kızıağı ile gönderilir
- » Paslanmaz AISI 304 çelik bağlantı ağızlı
- » AISI 316 L stainless steel plate
- » Multi-lingual interface
- » Programmable 24-hour time clock (4 time zones)
- » Accurate control to 0.5°C
- » With digital thermostat
- » Ready for installation, with heat exchanger studs and slide
- » Stainless steel AISI 304 connecting rod



**KOLAY
MONTAJ**
Easy Installation



**316
PASLANMAZ
ÇELİK**
Stainless Steel



**0.5 °C
HASSAS
KONTROL**
Precise Control

Maksimum Verimlilik

Maksimum Efficiency

KOD	HAVUZ m³	REJİM	EŞANJÖR KAPASİTESİ kcal/h	SICAKLIK	EŞANJÖR MODELİ	PLAKA SAYISI	ÇIKIŞ BAĞLANTI	FİYAT
CODE	POOL m³	HEATING DURATION	EXCHANGER CAPACITY kcal/h	TEMPERATURE	EXCHANGER MODEL	PLATE NUMBER	OUTLET CONNECTION	PRICE
16017122101	10	12	17.000	10-28	504	5	40 mm	420 \$
16017122102	15	12	25.000	10-28	504	5	40 mm	425 \$
16017122103	20	12	34.000	10-28	504	6	40 mm	435 \$
16017122104	25	12	42.000	10-28	504	7	40 mm	450 \$
16017122105	30	12	45.000	10-28	504	7	40 mm	455 \$
16017122106	35	12	52.500	10-28	504	8	40 mm	465 \$
16017122107	40	12	60.000	10-28	504	8	40 mm	470 \$
16017122108	45	12	67.500	10-28	504	9	40 mm	480 \$
16017122109	50	12	75.000	10-28	504	10	40 mm	495 \$
16017122110	60	12	90.000	10-28	504	11	40 mm	510 \$
16017122111	70	12	105.000	10-28	504	12	40 mm	525 \$
16017122112	80	12	120.000	10-28	504	14	40 mm	555 \$
16017122113	90	12	135.000	10-28	504	16	40 mm	585 \$
16017122114	100	12	150.000	10-28	504	16	40 mm	590 \$
16017122115	125	12	188.000	10-28	504	22	40 mm	675 \$
16017122116	150	12	225.000	10-28	504	26	40 mm	735 \$
16017122117	175	12	262.000	10-28	707	14	63 mm	1.215 \$
16017122118	200	12	300.000	10-28	707	17	63 mm	1.275 \$
16017122119	250	12	375.000	10-28	707	21	63 mm	1.365 \$
16017122120	300	12	450.000	10-28	707	26	63 mm	1.470 \$
16017122121	400	12	600.000	10-28	707	34	63 mm	1.650 \$
16017122122	500	12	750.000	10-28	707	46	63 mm	1.890 \$
16017122123	30	18	30.000	10-28	504	6	40 mm	435 \$
16017122124	35	18	35.000	10-28	504	6	40 mm	440 \$
16017122125	40	18	40.000	10-28	504	7	40 mm	450 \$
16017122126	45	18	45.000	10-28	504	7	40 mm	455 \$
16017122127	50	18	50.000	10-28	504	7	40 mm	460 \$
16017122128	60	18	60.000	10-28	504	8	40 mm	465 \$
16017122129	70	18	70.000	10-28	504	9	40 mm	480 \$
16017122130	80	18	80.000	10-28	504	10	40 mm	495 \$
16017122131	90	18	90.000	10-28	504	11	40 mm	510 \$
16017122132	100	18	100.000	10-28	504	12	40 mm	525 \$
16017122133	125	18	125.000	10-28	504	14	40 mm	555 \$
16017122134	150	18	150.000	10-28	504	16	40 mm	585 \$
16017122135	175	18	175.000	10-28	504	20	40 mm	600 \$
16017122136	200	18	200.000	10-28	504	24	40 mm	660 \$
16017122137	250	18	250.000	10-28	504	32	40 mm	780 \$
16017122138	300	18	300.000	10-28	707	17	63 mm	1.275 \$
16017122139	400	18	400.000	10-28	707	22	63 mm	1.380 \$
16017122140	500	18	500.000	10-28	707	28	63 mm	1.515 \$
16017122141	50	24	38.000	10-28	504	7	40 mm	450 \$
16017122142	60	24	45.000	10-28	504	7	40 mm	455 \$
16017122143	70	24	53.000	10-28	504	8	40 mm	465 \$
16017122144	80	24	60.000	10-28	504	8	40 mm	470 \$
16017122145	90	24	67.500	10-28	504	9	40 mm	480 \$
16017122146	100	24	75.000	10-28	504	10	40 mm	495 \$
16017122147	125	24	94.000	10-28	504	11	40 mm	510 \$
16017122148	150	24	112.500	10-28	504	13	40 mm	540 \$
16017122149	175	24	132.000	10-28	504	14	40 mm	555 \$
16017122150	200	24	150.000	10-28	504	16	40 mm	585 \$
16017122151	250	24	190.000	10-28	504	22	40 mm	630 \$
16017122152	300	24	225.000	10-28	504	26	40 mm	690 \$
16017122153	400	24	300.000	10-28	707	17	63 mm	1.275 \$
16017122154	500	24	375.000	10-28	707	21	63 mm	1.365 \$

Nem Alma Cihazı

Dehumidifier

PROFESYONEL KONTROL

PROFESSIONAL CONTROL

Yüksek kapasiteli nem alma gücüyle ticari havuz projelerine çözüm sunar. Düşük ses seviyesi ve çoklu koruma sistemiyle güvenilir performans sağlar.

Provides high-capacity dehumidification for commercial pool projects. Ensures reliable performance with low noise operation and multi-protection system.

AISI
316
PASLANMAZ ÇELİK
FAN MOTORU
STAINLESS STEEL
FAN MOTOR



Öne Çıkan Özellikler

Product Features

- » Kurulumu kolaydır, zemine veya duvara monte edilebilir
- » İsteğe bağlı akıllı, uzaktan veya kablolu kontrol cihazı eklenebilir
- » Korozyona dayanıklı dış kabin, çerçeve ve vidalar yüksek kalite sunar
- » Düşük sesli döner kompresör ve fan ile çalışır
- » Yüksek kaliteli filtre, havadaki toz ve kirleri temizler
- » Multi-Protection tasarımı; kompresör, basınç ve zamanlayıcı korumaları içerir
- » 24 saatlik programlama ile gün boyu açma-kapama ayarlanabilir.
- » Trapez iç dişli bakır boru ısı transferini artırır
- » Hidrofilik alüminyum folyo ısı eşanjörüyle yüksek verim sağlar
- » Easy to install, can be floor- or wall-mounted
- » Optional smart, remote, or wired controller
- » Corrosion-resistant cabinet, frame, and screws ensure quality
- » Operates with low-noise rotary compressor and fan
- » High-quality filter removes dust and dirt from the air
- » Multi-Protection design with compressor, pressure, and timer safeguards
- » 24-hour programming allows on/off scheduling throughout the day
- » Trapezoidal inner-grooved copper tube improves heat transfer
- » Hydrophilic aluminum foil heat exchanger ensures efficiency

	KALAHARİ 75	KALAHARİ 100	KALAHARİ 125	KALAHARİ 170
NEM ALMA KAPASİTE CAPACITY IN (kg/24h)	75	100	125	170
NOMİNAL ELEKTRİK TÜKETİMİ NOMINAL ELECTRICITY CONSUMPTION (kw)	1,30	1,73	2	2,92
ANMA AKIMI (A) RATED CURRENT (A)	5,9	7,9	9,1	13,3
SES ŞİDDETİ (db) SOUND LEVEL (sb)	48	50	50	52
SOĞUTUCU REFRIGERANT	R410 A	R410 A	R410 A	R410 A
GÜÇ KAYNAĞI POWER SUPPLY (V/PH/HZ)	220/1/50	220/1/50	220/1/50	220/1/50
HAVA DEBİSİ AIR FLOW (m ² /h)	600	1.200	1.200	1.800
NET ÖLÇÜLER NET DIMENSIONS (mm)	905x243x673	1288x243x673	1288x243x673	1672x243x673
AĞIRLIK (kg) WEIGHT (kg)	52	57	59	70
ÖLÇÜLER (UxDxG) DIMENSIONS (LxDxW)	1060x350x910 mm	1440x350x910	1440x350x910 mm	1810x350x910 mm
KOD CODE	16018123004	16018123005	16018123006	16018123007
FİYAT PRICE	3.780 €	4.500 €	5.025 €	5.990 €

ISI POMPASI

10,5 kw 16,5 kw 21 kw 24 kw
32,5 kw 65 kw 130 kw



WiFi App
Connected



Dc İnvertörlü Isı Pompası

Dc Inverter Heat Pump

AKILLI İNVERTER SMART INVERTER

Elektronik genişleme valfi ve inverter sistemiyle yüksek enerji tasarrufu sunar. Ticari projelerde uzun ömürlü çözümdür.

It offers high energy savings with its electronic expansion valve and inverter system. It is a long-lasting solution for commercial projects.



SESSİZ
SILENT

AISI
316
PASLANMAZ ÇELİK
STAINLESS STEEL



Öne Çıkan Özellikler Product Features

- » 10,5–130 kW aralığında havuz ısı pompası
- » Anti-Freeze fonksiyonu suyun donmasını önler
- » Spiral titanyum eşanjör yüksek verimlilik ve korozyon direnci sağlar
- » Çoklu koruma: su akış kontrolü, otomatik buz çözme, anti-donma
- » Akıllı buz çözme teknolojisi ısı kaybını azaltır, sıcaklığı korur
- » Elektronik genişleme valfi enerji tasarrufu ve yüksek verimlilik sunar
- » Otomatik ısıtma ve soğutma fonksiyonu
- » Gürültü emici katmanlarla ses yalıtımı
- » Swimming pool heat pump range from 10.5–130 kW
- » Anti-Freeze function prevents water circulation from freezing
- » Spiral titanium heat exchanger ensures high efficiency and corrosion resistance
- » Multi-Protection: water flow control, automatic defrost, anti-freeze, etc.
- » Smart defrost reduces defrosting time and keeps pool warm longer
- » Electronic expansion valve provides higher efficiency and energy savings
- » Automatic heating and cooling for the pool
- » Noise-absorbing layers ensure sound insulation



Çalışma videosunu izlemek için QR kodu okutun.

Scan the QR code to watch the working video.



Kullanım kılavuzu için QR kodu okutun.

Scan the QR code to manual.



KOD CODE	GÜÇ POWER	ÖLÇÜLER UxDxG DIMENSIONS LxDxW	FİYAT PRICE
16019123013	10,5 kW	1.130mm x 420mm x 760mm	2.745 €
16019123019	16,5 kW	1.180mm x 470mm x 860mm	3.250 €
16019123014	21 kW	1.230mm x 530mm x 1.100mm	4.300 €
16019123015	24 kW	1.230mm x 530mm x 1.100mm	5.300 €
16019123023	32,5 kW	1.250mm x 530mm x 1.480mm	8.075 €
16019123022	65 kW	1.240 mm x 500mm x 1.770mm	14.050 €
16019123071	130 kW	1.140mm x 1.280mm x 2.110mm	27.000 €

	10,5kW	16,5kW	21,0kW	24,0kW	32,5kW	65kW	130kW
ÇALIŞMA HAVASI SICAKLIĞI °C OPERATING AIR TEMPERATURE °C -15~43							
PERFORMANS DURUMU: HAVA 26°C, SU 26°C, NEM %80 – PERFORMANCE CONDITION: AIR 26°C, WATER 26°C, HUMIDITY 80%							
Booster modunda ısıtma kapasitesi (kw) Heating capacity (kw) in booster mode	10,5	16,5	21	24	32,5	65	150
Isıtma kapasitesi (kw) Heating capacity (kw)	9	14,5	18	21	27,5	10,6~65	10,6~65
Güçlendirici modunda cop Cop in booster mode	6,5	6,4	6,1	6,2	6,4	6,1	5,8
Cop	14.5~7.2	15.3~7.0	15.9~6.7	16.1~6.9	15.4~7.1	6.15~16.11	6.15~16.11
%50 Kapasitede cop Cop at 50% capacity	10,6	11,1	11,2	11,6	11,5	11,2	11,2
PERFORMANS DURUMU: HAVA 15°C, SU 26°C, NEM %80 – PERFORMANCE CONDITION: AIR 15°C, WATER 26°C, HUMIDITY 70%							
Booster modunda ısıtma kapasitesi (kw) Heating capacity (kw) in booster mode	7,25	11,5	14,5	16,5	21,5	50	50
Isıtma kapasitesi (kw) Heating capacity (kw)	6,23	10,5	12,5	14,5	18,5	8,02~50	126
Güçlendirici modunda cop Cop in booster mode	4,31	4,3	4,2	4,3	4,6	4,9	4,9
Cop	7.8~5.0	7.8~4.5	7.8~4.5	8.0~4.6	7.8~5.2	4.95~8.45	5,5
%50 Kapasitede cop Cop at 50% capacity	6,6	6,6	6,6	6,8	7,0	6,7	6,7
PERFORMANS DURUMU: HAVA 35°C, SU 28°C, NEM %80 – PERFORMANCE CONDITION: AIR 35°C, WATER 28°C, HUMIDITY 70%							
Soğutma kapasitesi (kw) Cooling capacity (kw)	4,9	6,9	7,8	10,5	12,7	35	90
1m dB(A)'da ses basıncı Sound pressure at 1m dB(A)	37.8~44.2	41.2~48.3	42.9~50.8	40.8~51.2	43.3~53.9	58	40
1m dB(A)'da %50 kapasiteli ses basıncı Sound pressure of 50% capacity at 1m dB(A)	22,5	32,2	44,5	44,4	46,4	29	20
10m dB(A)'da ses basıncı Sound pressure at 10m dB(A)	17.8~25.6	20.3~28.7	22.9~30.8	20.8~31.2	23.3~31.9	--	--
Isı Eşanjörü Heat exchanger	PVC'de spiral titanyum tüp Spiral titanium tube in PVC						
Kasa	Galvanizli metal kasa Galvanized metal casing						
Güç kaynağı Power supply	230 V/1 Ph/50Hz				380~400V/3 Ph/50Hz		
Havada nominal giriş gücü 15°C (kW) Rated input power at air 15°C (kW)	0.22~1.49	0.39~2.35	0.43~2.61	0.49~3.5	0.64~5.12	0.65~10.56	22,91
15°C havada (A) nominal giriş akımı Rated input current at air 15°C (A)	1.06~5.81	1.77~10.06	1.87~11.35	2.13~12.65	0.93~9.15	2.43~12.72	43,5
Önerilen su akışı (m³/h) Advised water flux (m³/h)	3~4	5,6	6,5~8,5	8~10	10~12	21	36,11
Su borusu giriş-çıkış boyutu (mm) Water pipe in-out size (mm)	50						63
Soğutucu Refrigerant	R410A						

Tavsiye Edilen Havuz Hacmi

Advised Pool Volume

10,5 kw: 20~40 m³	32,5 kw: 65~120 m³
16,5 kw: 35~55 m³	65 kw: 100~220 m³
21 kw: 40~75 m³	130 kw: 200~450 m³
24 kw: 50~95 m³	

Tanıtım videosunu
izlemek için QR kodu
okutun.



Scan the QR code to
watch the promotional
video.





NEW

Dc İnvertörlü Ev Tipi Isı Pompası

DC Inverter Residential Heat Pump

EV TİPİ İNVERTER RESIDENTIAL INVERTER

Ev tipi kullanım için tasarlanan DC inverter ısı pompası, konut projelerinde verimli ve güvenilir ısıtma ve soğutma sunar.

Designed for residential use, the DC inverter heat pump provides efficient and reliable heating and cooling for housing projects.



SESSİZ
SILENT

AISI
316
PASLANMAZ ÇELİK
STAINLESS STEEL

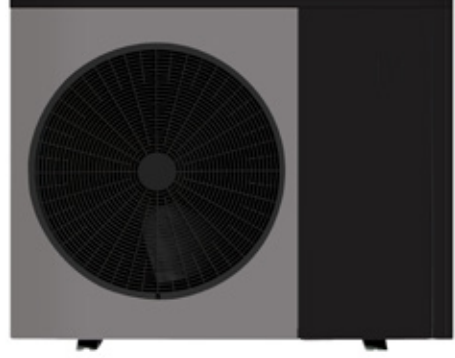

Öne Çıkan Özellikler Product Features

- » 10–36 kW aralığında ev tipi ısı pompası
- » Ev tipi kullanıma özel DC inverter teknolojisi
- » WiFi kontrol sayesinde telefon üzerinden uzaktan yönetim
- » Geniş dış ortam sıcaklık aralığında güvenli çalışma
- » Hızlı stabil kapasiteye ulaşma (standart modellere göre %50 daha hızlı)
- » İnverter kompresör ile %30'a varan enerji tasarrufu
- » Hassas sıcaklık kontrolü ile stabil iç ortam konforu
- » Geniş çalışma voltaj aralığı sayesinde elektrik dalgalanmalarına dayanıklı yapı
- » Alt gövdede özel anti-donma ve anti-buzlanma tasarımı
- » Full inverter teknolojisi ile ultra sessiz çalışma
- » Çoklu koruma sistemi (su akış, donma, basınç ve kompresör korumaları)
- » Residential heat pump range from 10–36 kW
- » DC inverter technology designed for residential use
- » WiFi control for remote operation via smartphone
- » Safe operation in a wide ambient temperature range
- » Fast stabilization to heating capacity (up to 50% faster than standard units)
- » Up to 30% energy saving with inverter compressor technology
- » Accurate temperature control for stable indoor comfort
- » Wide operating voltage range for protection against power fluctuations
- » Special anti-freezing and anti-frost design on bottom structure
- » Ultra-quiet operation with full inverter technology
- » Multi-protection system (water flow, anti-freeze, pressure and compressor protections)



SİSTEM AVANTAJLARI SYSTEM ADVANTAGES



Ev Tipi Tasarım
Home Design



Isıtma & Soğutma
Heating & Cooling



Yüksek Verimlilik
High Efficiency



Geniş Kapasite Aralığı
Wide Capacity Range

	FEIHC 10S	FEIHC 12S	FEIHC 15S	FEIHC 15S3	FEIHC 18S	FEIHC 18S3	FEIHC 24S3	FEIC 30S3	FEIC 36S3
Güç kaynağı (V/PH/Hz) Power supply (V/PH/Hz)	220/1/50	220/1/50	220/1/50	380/3/50	220/1/50	380/3/50	380/3/50	380/3/50	380/3/50

ISITMA KOŞULLARI: HAVA KURU/ISLAK 20/15°C, SU 15°C İLE 55°C ARASI - HEATING CONDITION: AIR DB/WB 20/15°C, WATER FROM 15°C to 55°C

Isıtma kapasitesi (kw) Heating capacity (kw)	12.3	16.4	20.5	20.5	24.6	24.6	32.8	41	49.2
Giriş gücü (kw) Input power (kw)	2,69	3,50	4,48	4,48	5,37	5,37	7,16	8,95	10,74
Cop	4,57	4,69	4,58	4,58	4,58	4,58	6,11	7,64	9,16

ISITMA KOŞULLARI: HAVA KURU/ISLAK 7/6°C, SU GİRİŞ/ÇIKIŞ 30/35°C - HEATING CONDITION: AIR DB/WB 7/6°C, WATER IN/OUT 30/35°C

Isıtma kapasitesi (kw) Heating capacity (kw)	10	12	15	15	18	18	24	30	36
Giriş gücü (kw) Input power (kw)	2,08	2,67	3,3	3,3	3,9	3,9	5,2	6,50	7,8
Giriş akımı (A) Input current (A)	9,65	12,38	15,00	5,39	17,73	6,42	8,56	10,70	12,84
Cop	4,42	4,5	4,4	4,4	4,62	4,62	4,62	4,62	4,62

ISITMA KOŞULLARI: HAVA KURU/ISLAK 7/6°C, SU GİRİŞ/ÇIKIŞ 50/55°C - HEATING CONDITION: AIR DB/WB 7/6°C, WATER IN/OUT 50/55°C

Isıtma kapasitesi (kw) Heating capacity (kw)	8.5	10.9	13.5	13.5	16,3	16,3	21,7	27,2	32,6
Giriş gücü (kw) Input power (kw)	2,98	3,73	4,82	4,82	5,64	5,64	7,5	9,4	11,28
Giriş akımı (A) Input current (A)	13,82	17,30	21,91	7,79	25,64	9,12	12,2	15,19	18,23
Cop	2,85	2,92	2,8	2,8	2,89	2,89	2,89	2,89	2,89

SOĞUTMA KOŞULLARI: HAVA KURU SICAKLIĞI 35°C, SU GİRİŞ/ÇIKIŞ SICAKLIĞI 12/7°C - COOLING CONDITION: AIR DB 35°C, WATER IN/OUT 12/7°C

Soğutma kapasitesi (kw) Cooling capacity (kw)	7.6	10.1	12,6	12,6	15	15	20	25	30
Giriş gücü (kw) Input power (kw)	2,59	3,36	4,26	4,26	4,93	4,93	6,57	8,21	9,852
Giriş akımı (A) Input current (A)	12,01	15,58	19,36	6,89	22,41	7,97	10,62	13,28	15,94
EER	2,93	3,01	2,96	2,96	3,04	3,04	3,04	3,04	3,04
Maksimum çalışma akımı (A) Max running current (A)	26,50	33,50	21,9	21,9	23,1	23,1	30,8	38,5	46,2
Gürültü seviyesi (Db) Noise (db (A))	48	50	52	52	53	53	54,0	67,5	81
Soğutucu Refrigerant	R32								

KOD CODE	GÜÇ POWER	ÖLÇÜLER UxDxG DIMENSIONS LxDxW	FİYAT PRICE
16019123083	10 kW Mono	1.050mm x 455mm x 788mm	6.350 €
16019123084	12 kW Mono	1.180mm x 455mm x 910mm	7.700 €
16019123085	15 kW Mono	1.000mm x 435mm x 1.335mm	9.150 €
16019123086	15 kW Tri	1.000mm x 435mm x 1.335mm	9.300 €
16019123087	18 kW Mono	1.000mm x 435mm x 1.335mm	9.750 €
16019123088	18 kW Tri	1.000mm x 435mm x 1.335mm	10.250 €
16019123089	24 kW Tri	1.170 mm x 455mm x 1.560mm	11.650 €
16019123090	30 kW Tri	1.170 mm x 455mm x 1.560mm	13.600 €
16019123091	36 kW Tri	1.170 mm x 455mm x 1.560mm	14.150 €

HAVUZ İÇİ VE KENAR KAPLAMA EKİPMANLARI POOL SURROUNDINGS

HAVUZ İÇİ VE KENAR KAPLAMA ÜRÜNLERİ POOL INDOOR AND OUTDOOR PRODUCTS

*Estetik ve Güvenlikte Yeni Standart
A New Standard in Aesthetics and Safety*

Dayanıklı Çözümler, Kusursuz Yüzeyler.
Durable Solutions, Flawless Surfaces.

Mimar ve uygulamacılar için kolay monte edilebilir, güvenilir ve estetik ürün seçenekleri.
Reliable, easy-to-install, and aesthetic product options for architects and contractors.

Liner Havuz Kaplamaları

Liner Pool Cover

Katman Yapısı Layer Structure

4. katman: Arttırılmış aşınma direnci, lekelenme direnci ve UV stabilitesi için tasarlanmış geliştirilmiş 4 katmanlı akrilik kaplama
4th later: enhanced 4 layered acrylic coating de signed for increased abrasion resistance, staining resistance and UV stability

3. katman: 750mic PVC katman, UV dayanımlı formüllü ve ayrıca yüksek ışık haslığına sahip baskı pigmentleri, mantar önleyici ve klorlu renk solma direnci
3rd layer: 750mic PVC layer, UV resistance formu lated as well as high light fastness print pigments, anti-fungal and chlorine color fading resistance

2. katman: Süper düşük büzülme ve yüksek boyutsal kararlılık özellikleri için tasarlanmış, fitil olmayan polyester ince kumaş
2nd layer: Non wick polyester scrim designed for super low shrink & high dimensional stability properties

Alt katman: 750mic PVC katman, UV direnci için formüle edilmiş ve ayrıca mantar önleyici ve klor renk solmasına karşı dirençli

Bottom layer: 750mic PVC layer, UV resistance for mulated as well as Anti-fungal and chlorine color fading resistance

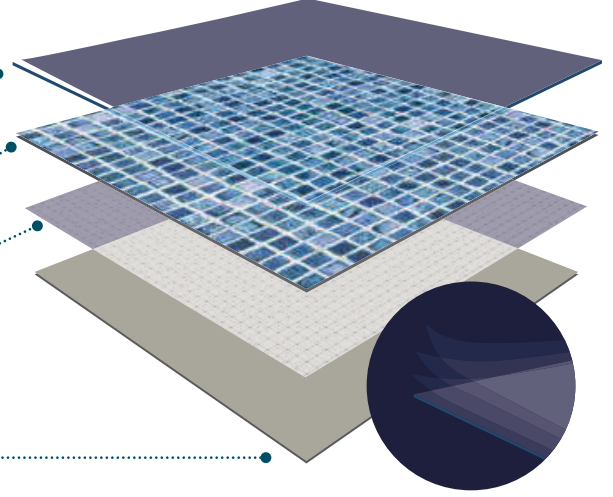

KOD CODE	ÜRÜN İSMİ PRODUCT NAME	KALINLIK THICKNESS	GENİŞLİK WIDTH	RULO m² ROLL m²	UZUNLUK LENGTH	FİYAT PRICE
327274340008	NEW Stoneflex Sapphire	1,5 mm	165 cm	41,25	25 mt	52,5 €
327274340009	NEW Stoneflex Urban 15	1,5 mm	165 cm	41,25	25 mt	52,5 €
327074334002	Stoneflex Royal	1,5 mm	165 cm	41,25	25 mt	52,5 €
327274340003	Stoneflex Jasper Sand	1,5 mm	165 cm	41,25	25 mt	52,5 €
327198042001	Stonetile Elegance	1,5 mm	165 cm	41,25	25 mt	52,5 €
327198042001	Stonetile Grey	1,5 mm	165 cm	41,25	25 mt	52,5 €
327198043002	Stonetile Golden	1,5 mm	165 cm	41,25	25 mt	52,5 €
327274340004	StoneFlex Forest	1,5 mm	165 cm	41,25	25 mt	52,5 €
327274340005	StoneTile Marine 15	1,5 mm	165 cm	41,25	25 mt	52,5 €
327274340006	StoneTile Tropic 15	1,5 mm	165 cm	41,25	25 mt	52,5 €
327074730001	Pacific	1,5 mm	165 cm	41,25	25 mt	26,5 €
67515123018	Galit Pvc	1,5 mm	165 cm	41,25	25 mt	26,5 €
67516123028	Navy Blue 8287	1,5 mm	165 cm	41,25	25 mt	23 €
67516123018	Light Blue 8286 Pvc	1,5 mm	165 cm	41,25	25 mt	23 €
67515123015	Sarı Kum Desenli Pvc	1,5 mm	165 cm	41,25	25 mt	23 €
67515123019	Snampir	1,5 mm	165 cm	41,25	25 mt	26,5 €
67515123020	Granit NG 1	1,5 mm	165 cm	41,25	25 mt	26,5 €
67516123029	Blue	1,5 mm	165 cm	41,25	25 mt	23 €
67515123011	Green	1,5 mm	165 cm	41,25	25 mt	23 €
67515123017	Grey	1,5 mm	165 cm	41,25	25 mt	23 €

Renk Seçenekleri

Color Options



StoneTile Sapphire



StoneTile Urban 15



StoneTile Marine 15



StoneTile Tropic 15



StoneFlex Bazelet



StoneFlex Concrete

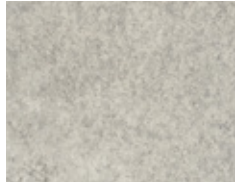

StoneFlex Ivory



StoneFlex Pearl



StoneFlex Royal



StoneFlex Sand



StoneFlex Slate

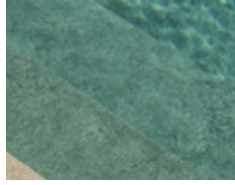

StoneFlex Forest



Larch Fesco



Larch Nature

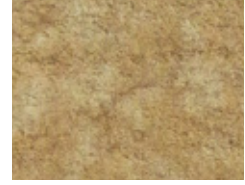

Sand

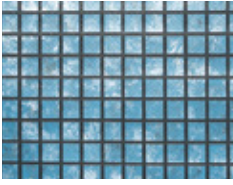

Matrix Black Blue

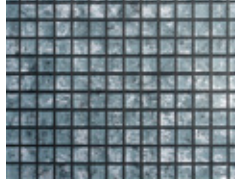

Matrix Black Silver

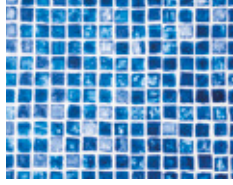

Snapir



Snapir Gold



Pacific

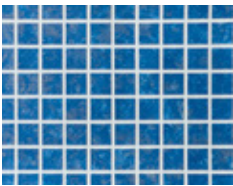

Matrix Blue

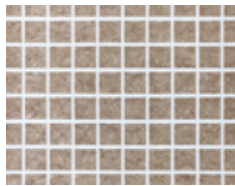

Matrix Dune

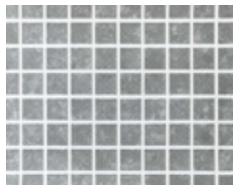

Matrix Silver

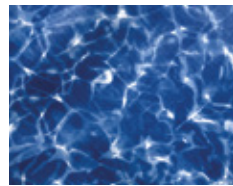

Cool Sparks

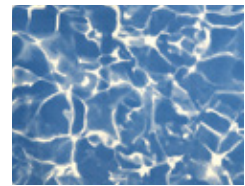

Galit NG



Granit NG 1

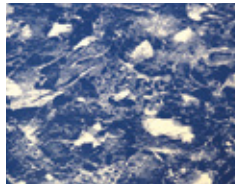

Granit NG 2



Navy Blue 8287



Blue



Light Blue 8286



Dark Grey 9133

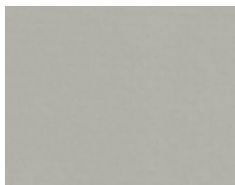

Grey



Green



Sand 3152

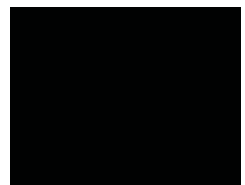

Black 9902

Stonetile Urban 15

NEW

Güçlendirilmiş 3D havuz membranı
Reinforced 3D pool membrane

Stonetile Sapphire

NEW

Stonetile Elegance

Taş yüzey hissi, kaymaz tutuş
Klor ve UV direnci, 15 yıldan fazla su yalıtım çözümleri!

*Stone surface feel, slip resistance
Superior chlorine and UV resistance!
Absolute waterproofing solution for over 15 years!*

tanıtım videosu



Stonetile Grey

Güçlendirilmiş 3D havuz membranı
Reinforced 3D pool membrane

Taş yüzey hissi, kaymaz tutuş
Klor ve UV direnci, 15 yıldan fazla su yalıtım çözümleri!

*Stone surface feel, slip resistance
Superior chlorine and UV resistance!
Absolute waterproofing solution for over 15 years!*

tanıtım videosu



Stonetile Emerald

Güçlendirilmiş 3D havuz membranı
Reinforced 3D pool membrane

tanıtım videosu



Stonetile Golden

Taş yüzey hissi, kaymaz tutuş
Klor ve UV direnci, 15 yıldan fazla su yalıtım çözümleri!

*Stone surface feel, slip resistance
Superior chlorine and UV resistance!
Absolute waterproofing solution for over 15 years!*

tanıtım videosu



Liner Yardımcı Ekipmanları

Liner Equipments

PVC Kaplı Metal Liner Montaj Çıtası Düz PVC Coated Metal Straight Liner Mounting Profile



KOD CODE	UZUNLUK LENGTH	FİYAT PRICE
69811002001	2 mt	5 € / mtül

Öne Çıkan Özellikler Product Features

- » PVC laminasyonu sayesinde linerin havuz duvarına tesbit edilmesi için uygun zemini oluşturur
- » Skimerli havuzlarda kullanıma uygundur
- » Thanks to its PVC lamination, the liner provides a suitable base for fastening to the pool wall.
- » Suitable for use in pools with skimmers.

PVC Kaplı Metal Liner Çıtası Kıvrılmış PVC Coated Metal Liner Fixing Profile

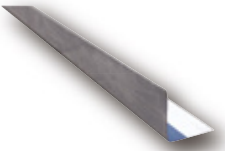

KOD CODE	UZUNLUK LENGTH	FİYAT PRICE
69811002002	2 mt	7 € / mtül

Öne Çıkan Özellikler Product Features

- » PVC laminasyonu sayesinde linerin havuz duvarına tesbit edilmesi için uygun zemini oluşturur
- » Taşmalı ve skimerli havuzlarda kullanıma uygundur
- » Thanks to its PVC lamination, the liner provides a suitable base for fastening to the pool wall
- » Suitable for use in overflow and skimmer pools

Liner Kenar Tutamağı Liner Handle



KOD CODE	FİYAT PRICE
69811002003	4 € / mtül

Öne Çıkan Özellikler Product Features

- » PVC'den üretilmiştir
- » Genelde hazır havuzların dikilmiş linerlarını asarak monte etmek için kullanılır
- » Made of PVC
- » It is generally used to hang up the liners to the pool wall edge

Liner Şeffaf Likit & Liner Mavi Likit

Liner Liquid Transparent & Liner Liquid Blue



KOD CODE	TANIM DESCRIPTION	GRAMAJ WEIGHT	FİYAT PRICE
0462701	Şeffaf <i>Transparent</i>	1 Lt	55 €
0462708	Mavi <i>Blue</i>	1 Lt	55 €
327274340007	Liner Forest Likit <i>Liquid</i>	1 Lt	--

Öne Çıkan Özellikler *Product Features*

- » Artan sağlamlığın yanı sıra dengelenmiş viskozite ve yeniden kullanılabilirlik özelliği
- » Increased durability, as well as stable viscosity & re-usable capability

Liner Keçesi

Liner Geotextile



KOD CODE	GRAMAJ WEIGHT	FİYAT PRICE
2099002610	250 gr	1.75 € / m ²
02099002613	500 gr	3.00 € / m ²

Öne Çıkan Özellikler *Product Features*

- » Taban betonundaki pürüzlü yüzeyin linera hasar vermesini önlemek için kullanılır
- » Used for preventing the rough surface of the base concrete from damaging to the liner
- » 1 rulo 100 mt
- » 1 rool 100 mt

Liner Tamir Kiti

Liner Vinly Pool Repair Kit



KOD CODE	GRAMAJ WEIGHT	FİYAT PRICE
69811123001	30 gr	7 €

Öne Çıkan Özellikler *Product Features*

- » Vinil yapıştırıcı, sünger fırça ve yama vinil içerir
- » Vinyl pool repair kit contains vinyl adhesive, dauber and patching vinyl
- » Su altında bile sıkıca bağlanır
- » It binds tight even under water

GRES ARAGÓN

SOLUTIONS FOR LIVING

Gres Aregon seramikleri İspanya'dan ithal. Avrupa standartlarında üretilmiş, projelerinize ayrıcalıklı bir hava katacak taş kaplama.

Gres Aregon ceramics are imported from Spain. A stone cladding manufactured to European standards will add a distinctive touch to your projects.

Havuz Seramikleri Pool Ceramics

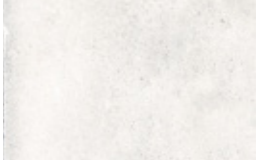

Urban Blanco



Urban Gris



Urban Beige



Urban Caoba

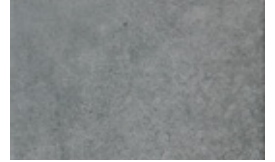

Urban Grafito



Tibet Blanco



Tibet Gris



Tibet Beige



Tibet Antracita



Marble Carrara Blanco



Marble Travertino Beige



Marble Pulpis

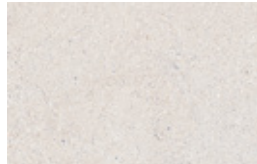

Cronos Blanco

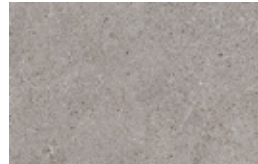

Cronos Gris

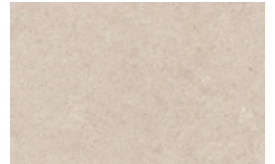

Cronos Crema



Marble Travertino Beige

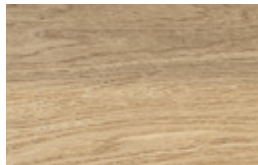

Marble Pulpis



Cronos Blanco

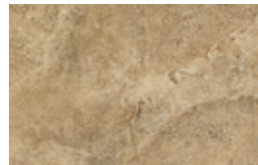

Cronos Gris

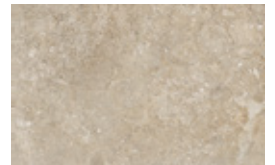

Cronos Crema

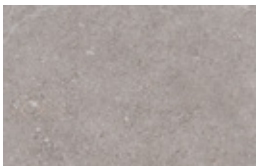

Petra Gris



Rodeno Haya

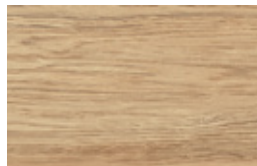

Rodeno Roble



Rodeno Nogal

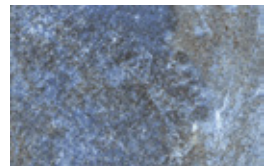

Ocean Blue Bali

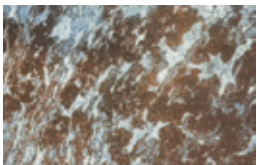

Ocean Coral Bay



Ocean Green River

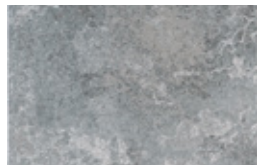

Ocean Pearl

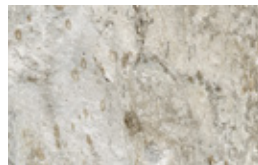

Itaca Gris

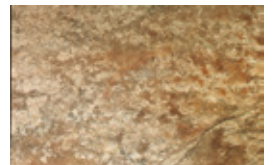

Itaca Mix



Nador Mix

Ölçüler Sizes

15x15 .

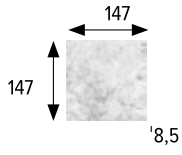

30x30 .

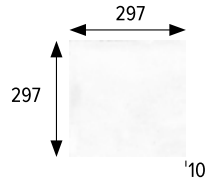

30x60 .



60x60 .

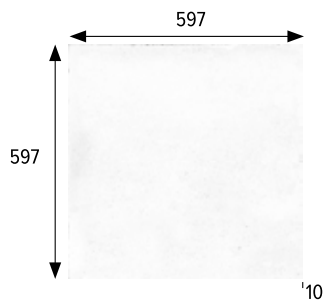

20x120 .











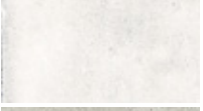

60x120 .

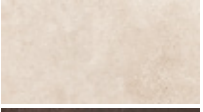

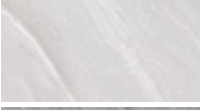
SERAMİK KODLARI BASES

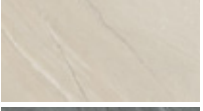
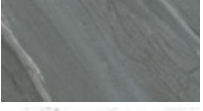
Rektifiye Edilmiş Rectified

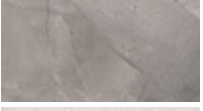
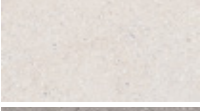
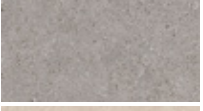
15x15 147x147x8,5 mm	30x30 297x297x10 mm	30x60 297x597x10 mm	60x60 597x597x10 mm	20x120 197x1197x10 mm	60x120 597x1197x10 mm
MC583	MC479	MC479	MC479	MC567	MC567

	URBAN BLANCO Kaymaz Anti Slip Düz Mat Smooth		Cod: 904237	Cod: 904245	Cod: 904253 Cod: 904249	Cod: 906199 Cod: 906280
	URBAN GRIS Kaymaz Anti Slip Düz Mat Smooth		Cod: 904238	Cod: 904246	Cod: 904254 Cod: 904250	Cod: 906198 Cod: 906345
	URBAN BEIGE Kaymaz Anti Slip Düz Mat Smooth		Cod: 904239	Cod: 904247	Cod: 904255 Cod: 904251	Cod: 906200 Cod: 906278
	URBAN CAOBA Kaymaz Anti Slip Düz Mat Smooth		Cod: 905634 Cod: 905776	Cod: 905635 Cod: 905636	Cod: 905637 Cod: 905638	Cod: 906249 Cod: 906250
	URBAN GRAFITO Kaymaz Anti Slip Düz Mat Smooth		Cod: 904763	Cod: 904765	Cod: 904767 Cod: 904766	Cod: 906281 Cod: 906282
	TIBET BIANCO Kaymaz Anti Slip Düz Mat Smooth		Cod: 904911	Cod: 904919		Cod: 906201 Cod: 906195
	TIBET GRIS Kaymaz Anti Slip Düz Mat Smooth		Cod: 904912	Cod: 904920		Cod: 906202 Cod: 906197
	TIBET BEIGE Kaymaz Anti Slip Düz Mat Smooth		Cod: 904913	Cod: 904921		Cod: 906203 Cod: 906274
	TIBET ANTRACITA Kaymaz Anti Slip Düz Mat Smooth		Cod: 904914	Cod: 904922		Cod: 906273 Cod: 906196
	CARRARA BIANCO Kaymaz Anti Slip Düz Mat Smooth			Cod: 905537		Cod: 906271 Cod: 906272
	TRAVERTINO BEIGE Kaymaz Anti Slip Düz Mat Smooth			Cod: 905538		Cod: 906275 Cod: 906276
	MARBLE PULPIS Kaymaz Anti Slip Düz Mat Smooth			Cod: 906367		Cod: 906369 Cod: 906368
	CRONOS BIANCO Kaymaz Anti Slip Düz Mat Smooth			Cod: 906391		Cod: 906394 Cod: 906397
	CRONOS GRIS Kaymaz Anti Slip Düz Mat Smooth			Cod: 906392		Cod: 906395 Cod: 906398
	CRONOS CREMA Kaymaz Anti Slip Düz Mat Smooth			Cod: 906393		Cod: 906396 Cod: 906399



SERAMİK KODLARI BASES

		Rektifiye Edilmiş Rectified					
		15x15 147x147x8,5 mm	30x30 297x297x10 mm	30x60 297x597x10 mm	60x60 597x597x10 mm	20x120 197x1197x10 mm	60x120 597x1197x10 mm
		MC583	MC479	MC479	MC479	MC567	MC567
	ORDESA BEIGE Kaymaz Anti Slip Düz Mat Smooth					Cod: 906259 Cod: 906283	
	ORDESA NATURAL Kaymaz Anti Slip Düz Mat Smooth					Cod: 906261 Cod: 906286	
	ORDESA MARRON Kaymaz Anti Slip Düz Mat Smooth					Cod: 905883 Cod: 906285	
	PETRA OCRE Kaymaz Anti Slip Düz Mat Smooth		Cod: 905908	Cod: 905907	Cod: 905906		Cod: 905905 Cod: 905904
	PETRA BEIGE Kaymaz Anti Slip Düz Mat Smooth		Cod: 905913	Cod: 905912	Cod: 905911		Cod: 905910 Cod: 905909
	PETRA GRIS Kaymaz Anti Slip Düz Mat Smooth		Cod: 905918	Cod: 905917	Cod: 905916		Cod: 905915 Cod: 905914
	RODENO HAYA Kaymaz Anti Slip Düz Mat Smooth					Cod: 906430 Cod: 906431	
	RODENO ROBLE Kaymaz Anti Slip Düz Mat Smooth					Cod: 906089 Cod: 906088	
	RODENO NOGAL Kaymaz Anti Slip Düz Mat Smooth					Cod: 906092 Cod: 906091	
	OCEAN BLUE BAL Kaymaz Anti Slip Düz Mat Smooth	Cod: 905574 Cod: 905573	Cod: 905565	Cod: 906362 Cod: 906381			
	OCEAN CORAL BAY Kaymaz Anti Slip Düz Mat Smooth	Cod: 905502 Cod: 905498	Cod: 904803				
	OCEAN GREEN RIVER Kaymaz Anti Slip Düz Mat Smooth	Cod: 905503 Cod: 905499	Cod: 904802	Cod: 906361 Cod: 906380			
	OCEAN PEARL Kaymaz Anti Slip Düz Mat Smooth	Cod: 905505 Cod: 905501	Cod: 905273				
	ITACA GRIS Kaymaz Anti Slip Düz Mat Smooth		Cod: 904075	Cod: 904089	Cod: 904129		
	ITACA MIX Kaymaz Anti Slip Düz Mat Smooth		Cod: 904079	Cod: 904093	Cod: 904133		
	NADOR MIX Kaymaz Anti Slip Düz Mat Smooth	Cod: 905788 Cod: 905789	Cod: 906242				

Straight stair-tread 60

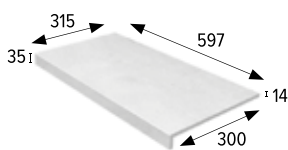

Straight stair-tread 120

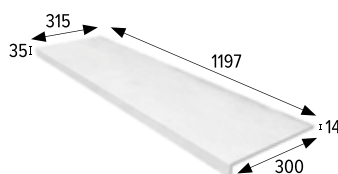

Straight stair-tread 150

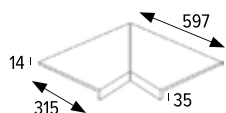
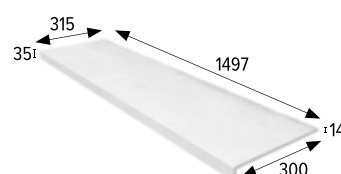

Mitered straight stair tread on demand

Straight stair-tread 180

*Available on demand.

Urban, Tibet, Marble, Cronos, Ordesa, Petra, Rodeno

Monocompact edge 120

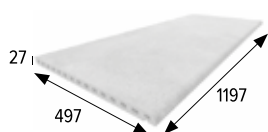

Overflow channel*

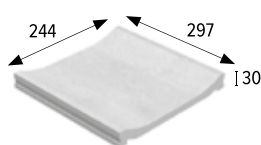

Bullnose

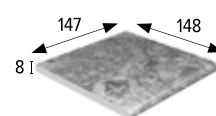











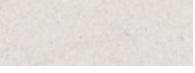

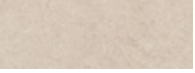
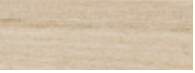
* Overflow channel with drainage available.

ÖZEL PARÇALAR SPECIAL PIECES

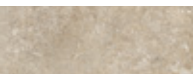
		Straight stair-tread 60 597x315x14 mm	Straight stair-tread 120 1197x315x14 mm	Straight stair-tread 150 1497x315x14 mm	Monocomp. edge 120 1197x497x27 mm	Overflow channel* 297x244x30 mm
		PZ603	PZ724	PZ750	PZ730	PZ382
	URBAN BLANCO Kaymaz Anti Slip	Cod: 970023	Cod: 970095	Cod: 970222	Cod: 970658	Cod: 904337
	URBAN GRIS Kaymaz Anti Slip	Cod: 970024	Cod: 970096	Cod: 970223	Cod: 970660	Cod: 904338
	URBAN BEIGE Kaymaz Anti Slip	Cod: 970025	Cod: 970097	Cod: 970227	Cod: 970659	Cod: 904339
	URBAN GRAFITO Kaymaz Anti Slip	Cod: 970090	Cod: 970091	Cod: 970364		Cod: 904787
	TIBET BIANCO Kaymaz Anti Slip		Cod: 970127	Cod: 970397	Cod: 970664	Cod: 905007
	TIBET GRIS Kaymaz Anti Slip		Cod: 970128	Cod: 970396		Cod: 905008
	TIBET BEIGE Kaymaz Anti Slip		Cod: 970129	Cod: 970395	Cod: 970665	Cod: 905009
	TIBET ANTRACITA Kaymaz Anti Slip		Cod: 970130	Cod: 970398		
	CARRARA BIANCO Kaymaz Anti Slip		Cod: 970178	Cod: 970225		
	TRAVERTINO BEIGE Kaymaz Anti Slip		Cod: 970179	Cod: 970224		
	MARBLE PULPIS Kaymaz Anti Slip		Cod: 970656	Cod: 970657		

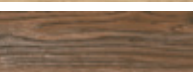
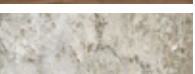

ÖZEL PARÇALAR SPECIAL PIECES

	Straight stair-tread 60 597x315x14 mm	Straight stair-tread 120 1197xx315x14 mm	Straight stair-tread 150 1497x315x14 mm	Monocomp. edge 120 1197x497x27 mm	Overflow channel* 297x244x30 mm
	MC583	MC479	MC479	MC479	MC567
	CRONOS BLANCO Kaymaz Anti Slip		Cod: 970679	Cod: 970685	
	CRONOS GRIS Kaymaz Anti Slip		Cod: 970680	Cod: 970686	
	CRONOS CREMA Kaymaz Anti Slip		Cod: 970681	Cod: 970687	
	ORDESA BEIGE Kaymaz Anti Slip	Cod: 970065	Cod: 970068	Cod: 970379	Cod: 904669
	ORDESA NATURAL Kaymaz Anti Slip	Cod: 970175	Cod: 970176	Cod: 970382	Cod: 905529
	ORDESA MARRON Kaymaz Anti Slip	Cod: 970066	Cod: 970069	Cod: 970381	Cod: 904670
	PETRA OCRE Kaymaz Anti Slip	Cod: 970441	Cod: 970439	Cod: 970457	Cod: 970661 Cod: 905964
	PETRA BEIGE Kaymaz Anti Slip	Cod: 970445	Cod: 970443	Cod: 970458	Cod: 970662 Cod: 905978
	PETRA GRIS Kaymaz Anti Slip	Cod: 970449	Cod: 970447	Cod: 970459	Cod: 970663 Cod: 905992
	RODENO HAYA Kaymaz Anti Slip	Cod: 970694	Cod: 970695	Cod: 970697	
	RODENO ROBLE Kaymaz Anti Slip	Cod: 970470	Cod: 970468	Cod: 970472	
	RODENO NOGAL Kaymaz Anti Slip	Cod: 970471	Cod: 970469	Cod: 970473	
	ITACA GRIS Kaymaz Anti Slip		Cod: 970043		
	ITACA MIX Kaymaz Anti Slip		Cod: 970044		

Bullnose
147x148x8 mm
PZ085

	OCEAN BLUE BALL Mat Matt Parlak Glossy	Cod: 905566 Cod: 905788
	OCEAN CORAL BAY Mat Matt Parlak Glossy	Cod: 905185 Cod: 905188
	OCEAN GREEN RIVER Mat Matt Parlak Glossy	Cod: 905183 Cod: 905186
	OCEAN PEARL Mat Matt Parlak Glossy	Cod: 905271 Cod: 905272
	NODOR MIX Mat Matt Parlak Glossy	Cod: 906327 Cod: 906326

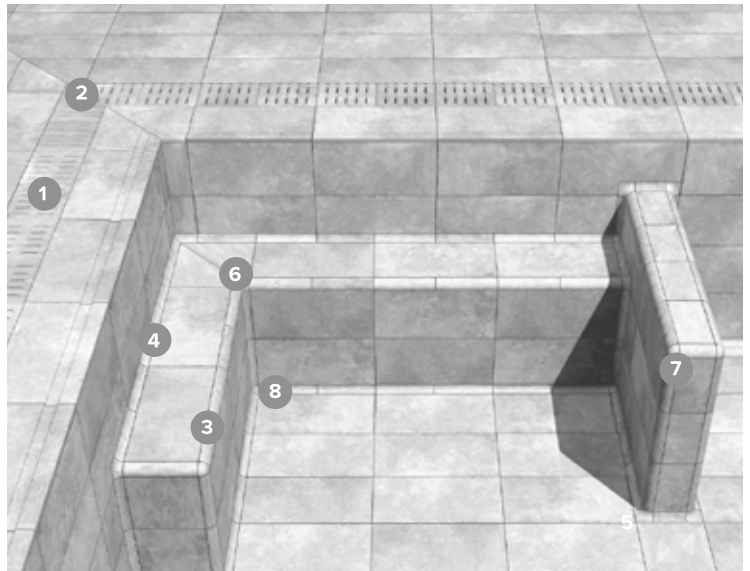

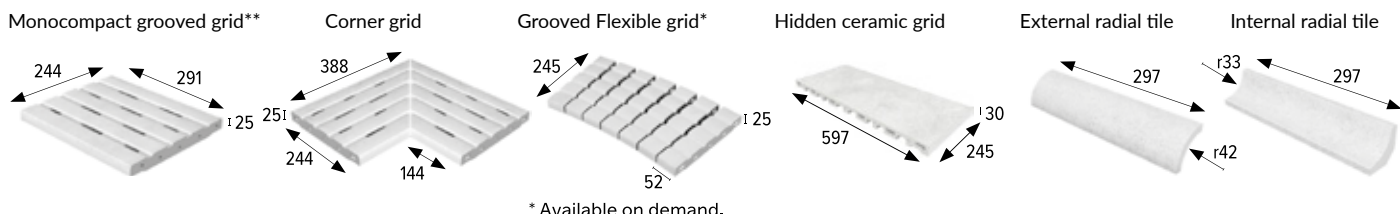

* Available on demand.

**Install the grids with the holes always parallel to the vessel to get a greater resistance, with a channel 250 mm wide.

ÖZEL PARÇALAR SPECIAL PIECES

		Monoc. grooved grid 291x244x25 mm	Corner grid 388x244x25x 144 mm	Grooved Flexible grid 245x52x25 mm	Hidden ceramic grid 597x245x30 mm	External radial tile 297x42 mm	Internal radial tile 297x42 mm
		PZ603	PZ724	PZ750	PZ730	PZ382	PZ382
	URBAN BLANCO Kaymaz Anti Slip	Cod: 905056	Cod: 905052	Cod: 905048	Cod: 970589	Cod: 904345	Cod: 904341
	URBAN GRIS Kaymaz Anti Slip	Cod: 904909	Cod: 905053	Cod: 905049	Cod: 970644	Cod: 904346	Cod: 904342
	URBAN BEIGE Kaymaz Anti Slip	Cod: 905058	Cod: 905054	Cod: 905050	Cod: 970645	Cod: 904347	Cod: 904343
	URBAN GRAFITO Kaymaz Anti Slip	Cod: 905059	Cod: 905055	Cod: 905051	Cod: 970725	Cod: 904790	Cod: 904789
	TIBET BIANCO Kaymaz Anti Slip	Cod: 904995	Cod: 904999	Cod: 905003	Cod: 970642	Cod: 905015	Cod: 905011
	TIBET GRIS Kaymaz Anti Slip	Cod: 904996	Cod: 905000	Cod: 905004	Cod: 970643	Cod: 905016	Cod: 905012
	TIBET BEIGE Kaymaz Anti Slip	Cod: 904997	Cod: 905001	Cod: 905005	Cod: 970726	Cod: 905017	Cod: 905013
	ORDESA BEIGE Kaymaz Anti Slip	Cod: 905038	Cod: 905040	Cod: 905035	Cod: 970728	Cod: 904675	Cod: 904678
	ORDESA NATURAL Kaymaz Anti Slip	Cod: 905526	Cod: 905527	Cod: 905528	Cod: 970591	Cod: 905531	Cod: 905532
	ORDESA MARRON Kaymaz Anti Slip	Cod: 905037	Cod: 905041	Cod: 905036	Cod: 970729	Cod: 904676	Cod: 904679
	PETRA ORCE Kaymaz Anti Slip	Cod: 905961	Cod: 905962	Cod: 905963	Cod: 970730	Cod: 905966	Cod: 905967
	PETRA BEIGE Kaymaz Anti Slip	Cod: 905975	Cod: 905976	Cod: 905977	Cod: 970590	Cod: 905980	Cod: 905981
	PETRA GRIS Kaymaz Anti Slip	Cod: 905989	Cod: 905990	Cod: 905991	Cod: 970646	Cod: 905994	Cod: 905995
	OCEAN BLUE BAL Kaymaz Anti Slip					Cod: 905567	Cod: 905568
	OCEAN CORAL BAY Kaymaz Anti Slip					Cod: 905170	Cod: 905167
	OCEAN GREEN RIVER Kaymaz Anti Slip					Cod: 905168	Cod: 905165
	OCEAN PEARL Kaymaz Anti Slip					Cod: 905266	Cod: 905265
	NADOR MIX Kaymaz Anti Slip					Cod: 906243	Cod: 906244

Kaymaz seramikler Anti slip tiles

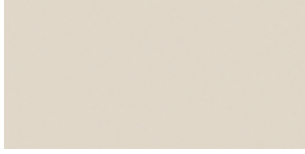

Aciker Natural Aciker

Duvar karoları Wall tiles

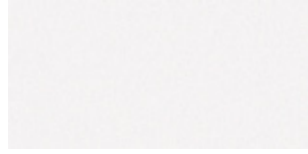

Blanco White



Azul palido Pale blue



Azul Blue



Azul oscuro Dark Blue



Aciker Gris Grey Aciker

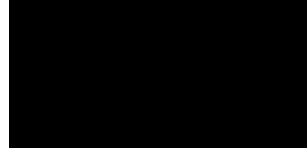

Negro Black

Oluklu seramikler Grooved tiles



Aciker Natural Aciker



Blanco White



Azul palido Pale blue



Azul Blue



Azul oscuro Dark Blue

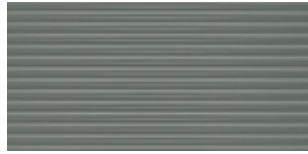

Aciker Gris Grey Aciker

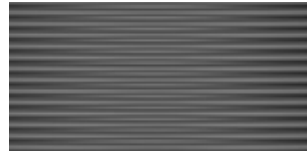

Negro Black

Hücre desenli Cell textures

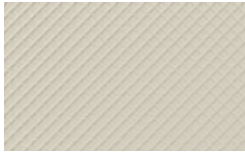

Aciker Natural Aciker

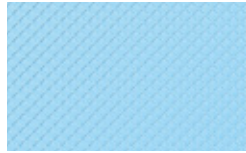

Azul palido Pale blue



Azul Blue

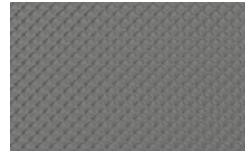

Aciker Gris Grey Aciker

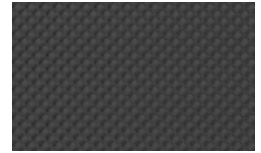

Negro Black

Kombinasyonlar Combinations

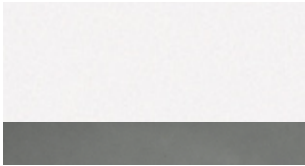

Blanco/Gris White/Grey



Azul/Azul oscuro Blue/Dark blue



Blanco/Azul oscuro
White/Dark blue



Natural/Azul oscuro
Natural/Dark blue

Ölçüler / Sizes (cm)

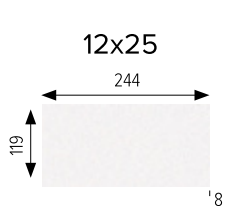

12x25

244

119

8

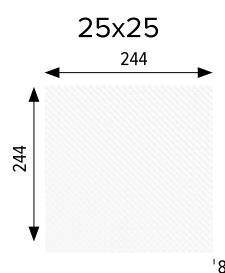

25x25

244

244

8



25x50

494

244

8,5

GRES ARAGÓN

SOLUTIONS FOR LIVING

TEMİZLİK VE BAKIM

Gres Aragón seramikleri, doğru temizlik uygulandığında uzun yıllar boyunca ilk günkü görünümünü korur. Uygulama sonrası, derz artıkları ve inşaat kalıntıları hafif asidik temizlik ürünleriyle temizlenmelidir.

Günlük bakımda ise nötr deterjanlar tercih edilmelidir. Balmumu veya yağ içeren ürünlerden kaçınılması, yüzeyin kaymazlığını ve estetiğini korur.

CLEANING & MAINTENANCE

Gres Aragón ceramics retain their original appearance for years with proper cleaning. After installation, grout residues and construction dirt should be removed using slightly acidic detergents.

For everyday maintenance, neutral cleaners are recommended. Avoid wax- or oil-based products to preserve the non-slip and aesthetic qualities of the surface.

Havuz Tutamakları & Kaymazları

Porcelain Pool Handless & Antislip Tiles



Tutamak Kobalt Handle Cobalt

KOD CODE	MODEL	ÖLÇÜ SIZE
580151002	Pötikare <i>Petit Carre</i>	12x25 cm
68015152001	Düz <i>Universal</i>	12x25 cm



Oluklu Tutamak Kobalt Grooved Handle Cobalt

KOD CODE	MODEL	ÖLÇÜ SIZE
68015152009	Pötikare <i>Petit Carre</i>	12x25 cm



Büyük Tutamak Kobalt Big Handle Cobalt

KOD CODE	MODEL	ÖLÇÜ SIZE
580151014	Pötikare <i>Petit Carre</i>	25x25 cm
580151026	Pötikare <i>Petit Carre</i>	30x25 cm
68016152001	Düz <i>Universal</i>	25x25 cm



Oluklu Büyük Tutamak Kobalt Grooved Big Handle Cobalt

KOD CODE	MODEL	ÖLÇÜ SIZE
68015152012	Pötikare <i>Petit Carre</i>	25x25 cm
68015152013	Pötikare <i>Petit Carre</i>	30x25 cm



Profilli Büyük Tutamak Kobalt Big Handle Big Profile Cobalt

KOD CODE	MODEL	ÖLÇÜ SIZE
580151016	Pötikare <i>Petit Carre</i>	25x25 cm
580151018	Pötikare <i>Petit Carre</i>	30x25 cm

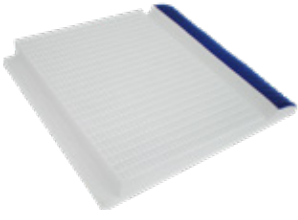

Profilli Oluklu Büyük Tutamak Kobalt *Big Handle With Profile Grooved Cobalt*

KOD CODE	ÖLÇÜ SIZE
580151020	25x25 cm
580151019	30x25 cm

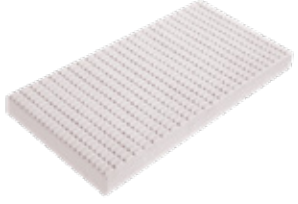

Sırsız Kaymaz *Unglazed Antisip*

KOD CODE	ÖLÇÜ SIZE
580151007	12x25 cm



Profilli Sırsız Kaymaz *Unglazed Antisip With Profile*

KOD CODE	ÖLÇÜ SIZE
580151017	12x25 cm



Dış Köşe *External Corner Cobalt*

KOD CODE	ÖLÇÜ SIZE
580151024	12,5x12,5 cm
580151025	25x25 cm



İç Köşe *Internal Corner Cobalt*

KOD CODE	ÖLÇÜ SIZE
580151010	25x25 cm
580151023	30x25 cm

JAKUZI VE SPA EKİPMANLARI JACUZZI AND SPA EQUIPMENT



JAKUZI VE SPA ÜRÜNLERİ JACUZZI AND SPA PRODUCTS

*Profesyonel Spa Çözümleri
Professional Spa Solutions*

Jakuzi ve Spa Teknolojisi.
Jacuzzi and Spa Technology.

Uzmanlar için tasarlandı. Emiş süzgeçlerinden kollektörlere kadar tüm spa ve jakuzi ekipmanları, güvenilir performans ve kolay montaj avantajı sunar.

Designed for experts. From suction strainers to collectors, all spa and jacuzzi equipment offers reliable performance and easy installation.

Spa&Jakuzi Gvde ve Jetleri

Spa & Jacuzzi Body and Jets

Ø32 Mm Hava ve Ø32 Su Çıkışlı
Ø32 Mm Air and Ø32 Water Outlet

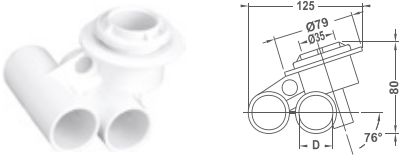

KOD CODE	MODEL	FİYAT PRICE
43015123001	WF 1138	8.80 €

Damla Model Jakuzi Seti
Face Eyeball Spa Jet

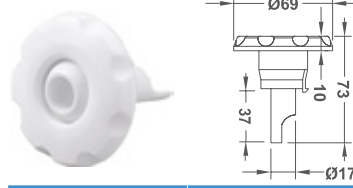

KOD CODE	MODEL	FİYAT PRICE
43015123002	WF 1113B	7.70 €

Şok Duş Seti
Barb Jet



KOD CODE	MODEL	FİYAT PRICE
43015123004	WF 0054	9.90 €

Dner Tip Ø11 ½" Jet Contasıyla
Ø11 ½" Face Swirl Jet With Gasket



KOD CODE	MODEL	FİYAT PRICE
43015123005	WF 2206	8.80 €

Ø32 Mm Hava ve Ø50 Su Çıkışlı
Ø32 Mm Air and Ø50 Water Outlet

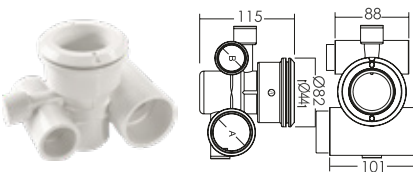

KOD CODE	MODEL	FİYAT PRICE
43015123006	WF 0031	15 €

Düz Görnml (Standart) Jet
Smooth Face (Swirl Jet)



KOD CODE	MODEL	FİYAT PRICE
43015123007	WF 0044	11 €

Döner Tip Jet Rotary Type Jet

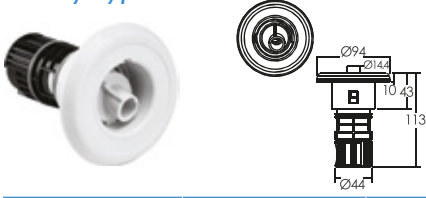

KOD CODE	MODEL	FİYAT PRICE
43015123008	WF 0048	11 €

Damla Model Döner Jet Drop Type Adjustable Jet



KOD CODE	MODEL	FİYAT PRICE
43015123009	WF 0018	18.50 €

Pnomatik Buton Pneumatic Button

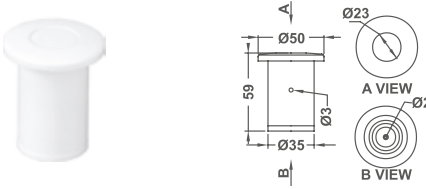

KOD CODE	MODEL	FİYAT PRICE
43016123003	WF 1844 B-ABS	3.00 €
43016123004	WF-1844K-SS 304	--

Jakuzi pompası veya blower için açma-kapama butonu.
On/Off button for jacuzzi pump or blower.

Hava Ayar Butonu Air Adjustment Button

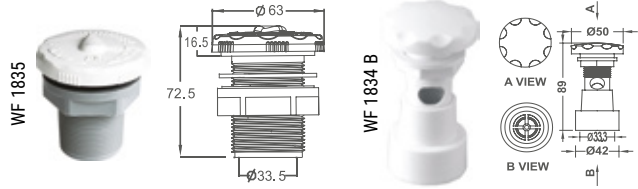

KOD CODE	MODEL	FİYAT PRICE
43016123005	WF 1834 B	5.00 €
43016123001	WF 1835	6.00 €

Jakuzi jetlerine hava veren ve seviyesi ayarlanabilen butonlardır.
Air control buttons for jacuzzi jets, with adjustable flow.

9 Delikli Blower Nozulu 9 Hole Nozzle

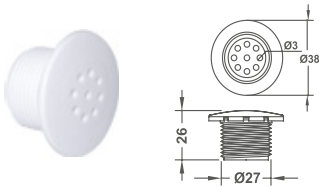

KOD CODE	MODEL	FİYAT PRICE
43016123002	WF 2211 B	4.00 €

Blower havasının çıkışını sağlayan nozullardır.
These are the nozzles that allow the blower air to escape.

Blower Nozulu Air Blower Nozzle

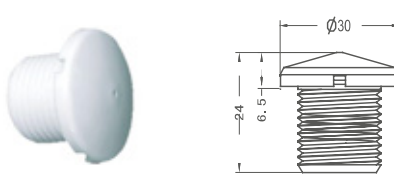

KOD CODE	MODEL	FİYAT PRICE
43016123007	WF 2209	2.00 €

Blower havasının çıkışını sağlayan nozullardır.
These are the nozzles that allow the blower air to escape.

Jakuzi Emiş Süzgeçleri 50 mm Jacuzzi Drains 50 mm

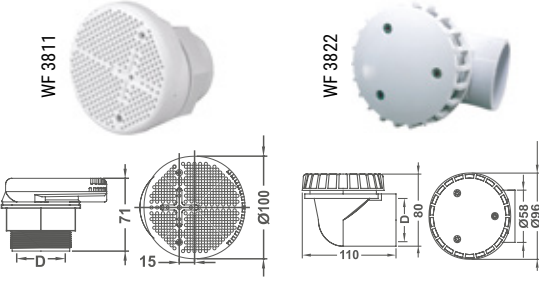

KOD CODE	MODEL	ÜRÜN TANIMI DESCRIPTION	FİYAT PRICE
43017123001	WF 3811	Delikli <i>Perforated</i>	22.00 €
43017123002	WF 3822 B	Yapıştırılmalı <i>Cemented</i>	23.10 €

Suyun tahliyesini sağlar.
It ensures the drainage of water.

Waterfun Kalitesi / Quality of Waterfun

Jakuzi Kollektörleri Jacuzzi Collectors

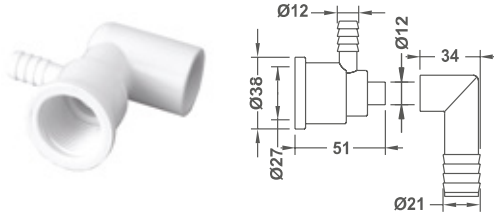

KOD CODE	MODEL	FİYAT PRICE
43018123001	WF 2201 B	4.40 €

Tesisatta hava ve/veya su dağıtımında kullanılan kollektörlerdir.
Ø10 mm hava, Ø15 mm su girişi.
Air/water distribution collectors. Ø10 mm air, Ø15 mm water inlet.

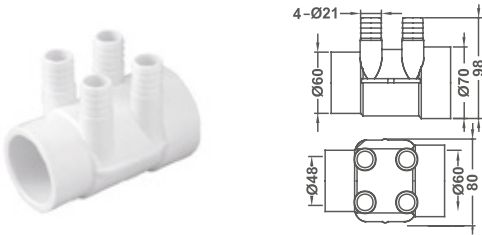

KOD CODE	MODEL	FİYAT PRICE
43018123002	WF 1824	16.50 €

Tesisatta hava ve/veya su dağıtımında kullanılan kollektörlerdir.
4 çıkışlı su kollektörü, Ø40 x 50 x 20 mm.
Air/water distribution collectors. 4-outlet water collector, Ø40 x 50 x 20 mm.

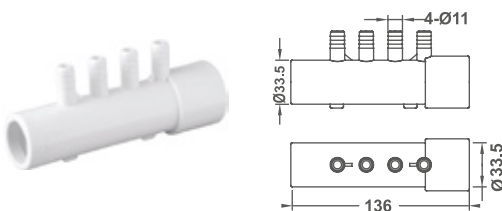

KOD CODE	MODEL	FİYAT PRICE
43018123003	WF 1825	18.70 €

Tesisatta hava ve/veya su dağıtımında kullanılan kollektörlerdir.
4 çıkışlı hava kollektörü, Ø25 x 10 mm.
Air/water distribution collectors. 4-outlet air collector, Ø25 x 10 mm.



KOD CODE	MODEL	FİYAT PRICE
43018123004	WF 1865	19.80 €

Tesisatta hava ve/veya su dağıtımında kullanılan kollektörlerdir.
8 çıkışlı hava kollektörü, Ø40 x 10 mm.
Air/water distribution collectors. 8-outlet air collector, Ø40 x 10 mm.



KOD CODE	MODEL	FİYAT PRICE
43018123005	WF 1864	22.00 €

Tesisatta hava ve/veya su dağıtımında kullanılan kollektörlerdir.
8 çıkışlı hava kollektörü, Ø40 x 20 mm.
Air/water distribution collectors. 8-outlet air collector, Ø40 x 20 mm.



Jakuzi Hortumları Jacuzzi Hoses

Öne Çıkan Özellikler Product Features

- » PVC'den üretilmiştir
- » Esnekliği sayesinde dairesel yapılarda kolay montaj imkanı tanır
- » 25 metre rulo uzunluğu
- » Made of PVC
- » Thanks to its flexibility, it allows easy assembly in circular structures
- » 25 meters roll length



KOD CODE	ÇAP DIA	FİYAT PRICE
43019002001	32 mm	7.50 €
43019002002	50 mm	11.50 €
43019002003	63 mm	12.50 €
43019002005	75 mm	22.00 €
43019002004	90 mm	23.00 €



Jakuzi Hava Bloweri Jacuzzi Air Blower

Öne Çıkan Özellikler Product Features

- » Düşük enerji tüketimi ve kompakt tasarımıyla dar alanlarda kullanıma uygundur
- » Low energy consumption and compact design, suitable even for limited spaces



KOD CODE	MODEL	WATT	FİYAT PRICE
43021123001	EB 350	220V - 350W	85 €
43021123003	EB 450	220V - 450W	120 €
43021123002	EB 550	220V - 550W	125 €

Blower Wf Model



KOD CODE	MODEL	FAZ PHASE	BAĞLANTI CONNECTION	DESİBEL DECIBEL	FİYAT PRICE
16017124006	1,1 kW MONO WF	II	2"	64db	380 €
16017124007	1,3 kW MONO WF	II	2"	64db	390 €
16017124008	1,5 kW MONO WF	II	2"	64db	440 €
16017124009	2,2 kW MONO WF	II	2"	64db	530 €
16017124010	1,1 kW TRI WF	III	2"	64db	360 €
16017124011	1,3 kW TRI WF	III	2"	64db	370 €
16017124012	1,5 kW TRI WF	III	2"	64db	430 €
16017124013	2,2 kW TRI WF	III	2"	70 db	520 €

Öne Çıkan Özellikler Product Features

- » Alüminyum alaşım gövde
- » Kuru hava transferine uygun
- » Sürekli çalışmaya dayanıklı
- » Dikey/yatay montaj imkânı
- » Düşük bakım maliyeti
- » Kolay montaj & sessiz çalışma
- » 50/60 Hz trifaze motor
- » Aluminum alloy body
- » Suitable for dry air transfer
- » Designed for continuous operation
- » Vertical/horizontal installation
- » Low maintenance cost
- » Easy installation & quiet operation
- » Three-phase motor, 50/60 Hz

Blower Yedekleri Blower Parts



KOD CODE	TANIM DESCRIPTION	FİYAT PRICE
49811122001	2- Emiş Takımı (İtalya) Suction Kid (Italy)	65 €
16017124015	1- Emiş Nozulu Suction Nozzle Waterfun	40 €
16017124014	Susturucu Silencer Waterfun	40 €

SAUNA VE BUHAR EKİPMANLARI SAUNA AND STREAM EQUIPMENT

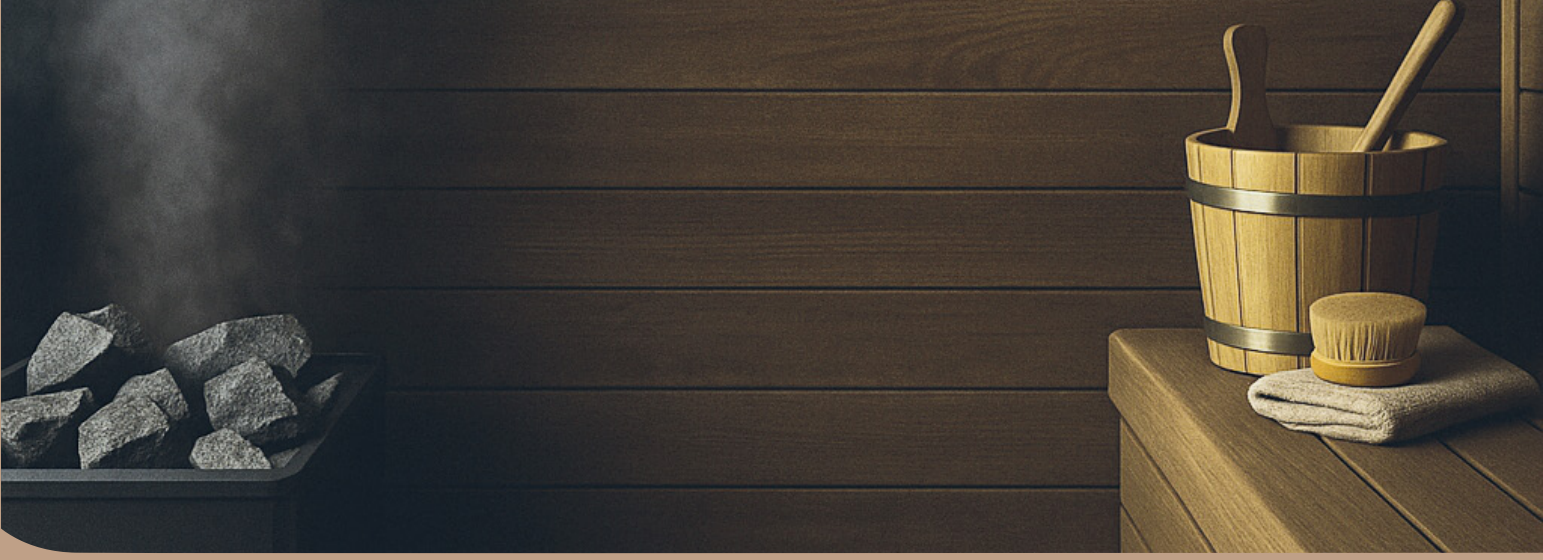

SAUNA VE BUHAR ÜRÜNLERİ SAUNA AND STREAM PRODUCTS

*Güvenilir Ekipman, Uzun Ömürlü Performans
Reliable Equipment, Long-Lasting Performance*

Sauna, Buhar ve Konfor Teknolojisi.
Sauna, Steam and Comfort Technology..

Sauna sobalarından buhar jeneratörlerine, aksesuarlarından kontrol sistemlerine kadar tüm ihtiyaçlarınıza profesyonel çözümler sunar.

It offers professional solutions for all your needs, from sauna stoves to steam generators, from accessories to control systems.

Sauna Isıtıcıları Sauna Heaters



Mw Model

Öne Çıkan Özellikler Product Features

- » Kompakt tasarımıyla küçük saunalar için idealdir
- » Ahşap panelleriyle mekânda bütünlük sağlar
- » Üst bölümdeki kontrol düğmeleriyle kolay erişim sunar
- » Pratik kullanım ve montaj imkânı verir
- » Compact design, ideal for small saunas
- » Wooden panels ensure visual integrity
- » Easy access with top-mounted control knobs
- » Provides practical use and installation



KOD CODE	GÜÇ POWER	TAŞ KAPASİTESİ STONE CAPACITY	SAUNA HACMİ SAUNA VOLUME	FİYAT PRICE
21015143014	3 kW	10 Kg	Max. 1,5-3 m ³	302 €
21015143013	3,6 kW	10 Kg	Max. 2-4,5 m ³	312 €

Ftn Model

Öne Çıkan Özellikler Product Features

- » Kontrol düğmeleriyle kolay kumanda
- » 3 saate kadar kesintisiz çalışma
- » Özel boyalı gövde ile pas direnci
- » Paslanmaz çelik koruyucu üst başlık
- » Yüksek verimli özel rezistanslar
- » Aşırı ısınmada güvenlik termostatu
- » Geniş taş haznesi ile hızlı buharlaşma
- » Easy control with built-in knobs
- » Continuous operation up to 3 hours
- » Anti-corrosion coated body
- » Stainless steel top cover
- » High-efficiency heating elements
- » Safety thermostat against overheating
- » Large stone tray for rapid vaporization



KOD CODE	GÜÇ POWER	TAŞ KAPASİTESİ STONE CAPACITY	SAUNA HACMİ SAUNA VOLUME	FİYAT PRICE
21015143008	3 kW	20 Kg	Max. 2-4 m ³	269 €
21015143009	4,5 kW	20 Kg	Max. 3-6 m ³	282 €
21015143010	6 kW	20 Kg	Max. 5-9 m ³	299 €
21015143011	8 kW	20 Kg	Max. 8-12 m ³	308 €
21015143012	9 kW	20 Kg	Max. 9-13 m ³	322 €

Club Model

Öne Çıkan Özellikler Product Features

- » Dijital veya manuel panel ile kontrol
- » Manuelde 3 saat, dijitalde 4 saate kadar kesintisiz çalışma
- » Özel boyalı gövde ile pas direnci
- » Paslanmaz çelik üst kapak
- » Yüksek verimli özel rezistanslar
- » Aşırı ısınmada güvenlik termostati
- » Geniş taş haznesi ile hızlı buharlaşma
- » Control via digital or manual panel
- » Up to 3 hours with manual, 4 hours with digital operation
- » Anti-corrosion coated body
- » Stainless steel top cover
- » High-efficiency heating elements
- » Safety thermostat against overheating
- » Large stone tray for fast vaporization



KOD CODE	GÜÇ POWER	TAŞ KAPASİTESİ STONE CAPACITY	SAUNA HACMİ SAUNA VOLUME	FİYAT PRICE
21016143044	3 kW	20 Kg	Max. 2-4 m ³	234 €
21016143043	4,5 kW	20 Kg	Max. 3-6 m ³	239 €
21016143042	6 kW	20 Kg	Max. 5-9 m ³	250 €
21016143041	8 kW	20 Kg	Max. 8-12 m ³	270 €
21016143040	9 kW	20 Kg	Max. 9-13 m ³	279 €

Uygun Olan Panolar Suitable Control Box



21017143001 Manual 3-9 kW 125 €



21017143004 Dijital 3-9 kW 175 €

Club Model

**AISI
316**
PASLANMAZ ÇELİK GÖVDE
STAINLESS STEEL BODY

Öne Çıkan Özellikler *Product Features*

- » Dijital veya manuel panel ile kontrol
- » Manuelde 3 saat, dijitalde 4 saate kadar çalışma
- » Şık tasarımlı AISI 316 paslanmaz çelik gövde
- » 15 kW ve üzeri modellerde güç kontrol paneli gerekir
- » Yüksek verimli özel rezistanslar
- » Aşırı ısınmada güvenlik termostati
- » Geniş taş haznesi ile hızlı buharlaşma
- » Control via digital or manual panel
- » Up to 3 hours (manual), 4 hours (digital) operation
- » Stylish AISI 316 stainless steel body
- » Power control panel required for 15 kW+ models
- » High-efficiency heating elements
- » Safety thermostat against overheating
- » Large stone tray for fast vaporization



KOD CODE	GÜÇ POWER	TAŞ KAPASİTESİ STONE CAPACITY	SAUNA HACMİ SAUNA VOLUME	FİYAT PRICE
21016143039	10,5 kW	40 Kg	Max. 10-15 m ³	1.100 €
21016143038	12 kW	40 Kg	Max. 11-18 m ³	1.150 €
21016143037	15 kW	40 Kg	Max. 14-24 m ³	1.170 €
21016143036	18kW	40 Kg	Max. 18-30 m ³	1.630 €
21016143035	21 kW	40 Kg	Max. 23-36 m ³	1.950€
21016143034	27 kW	40 Kg	Max. 29-47 m ³	2.020 €

Uygun Olan Panolar *Suitable Control Box*



21017143002	Manual	10,5-15 kW	140 €
21017143003	Manual	18-30 kW	115 €



21017143005	Dijital	10,5-15 kW	175 €
21017143006	Dijital	18-30 kW	175 €



21017143007 300 €



Round Model

AISI 316
PASLANMAZ ÇELİK GÖVDE
STAINLESS STEEL BODY

Öne Çıkan Özellikler Product Features

- » Dijital panel ile kontrol
- » 4 saate kadar kesintisiz çalışma
- » Oval tasarımıyla şık görünüm
- » Yüksek verimli rezistanslar
- » Aşırı ısınmada güvenlik termostatu
- » Control via digital panel
- » Continuous operation up to 4 hours
- » Elegant oval design
- » High-efficiency heating elements
- » Safety thermostat against overheating



KOD CODE	GÜÇ POWER	TAŞ KAPASİTESİ STONE CAPACITY	SAUNA HACMİ SAUNA VOLUME	FİYAT PRICE
21016143033	3 kW	12,5 Kg	Max. 2-4 m ³	420 €
21016143032	4,5 kW	12,5 Kg	Max. 3-6 m ³	433 €
21016143031	6 kW	12,5 Kg	Max. 5-9 m ³	568 €
21016143030	8 kW	12,5 Kg	Max. 8-12 m ³	596 €
21016143029	9 kW	12,5 Kg	Max. 9-13 m ³	618 €

Uygun Olan Panolar Suitable Control Box



21017143004 Dijital 3-9 kW 175 €

Combi Model

AISI 316
PASLANMAZ ÇELİK GÖVDE
STAINLESS STEEL BODY

Öne Çıkan Özellikler Product Features

- » Isıtıcıya ek olarak buhar özelliği
- » 4 lt hazne ile kesintisiz buhar
- » Özel kumanda paneli ile kontrol
- » Güç kontrol paneli ile kullanım
- » Şık AISI 316 paslanmaz çelik gövde
- » Yüksek verimli rezistanslar
- » Aşırı ısınmada güvenlik termostatu
- » Geniş taş haznesi ile hızlı buharlaşma
- » Heating function with additional steam feature
- » Continuous steam with 4 litre chamber
- » Controlled via dedicated panel
- » Requires power control panel
- » Elegant AISI 316 stainless steel body
- » High-efficiency heating elements
- » Safety thermostat against overheating
- » Large stone tray for fast vaporization



KOD CODE	GÜÇ POWER	TAŞ KAPASİTESİ STONE CAPACITY	SAUNA HACMİ SAUNA VOLUME	FİYAT PRICE
21016143028	3+2	12,8 kg	Max. 2-4 m ³	485 €
21016143027	4,5+2	13,1 kg	Max. 3-6 m ³	516 €
21016143026	6+2	13,4 kg	Max. 5-9 m ³	669 €
21016143025	8+2	14,2 kg	Max. 8-12 m ³	729 €
21016143024	9+2,5	14,0 kg	Max. 9-13 m ³	797 €

Combi Model İçin Dijital Kumanda Panosu Dijital Control Panel For Combi Model



KOD CODE	GÜÇ POWER	FİYAT PRICE
21017143008	3-9 kW	313 €

Dijital ekran, 110°C'ye kadar ayarlanabilir termostat
4 saate kadar timer, sauna aydınlatma kontrol butonu,
güç kontrol paneli ile kullanım.

Digital display, adjustable thermostat up to 110°C,
timer up to 4 hours, button for sauna lighting control,
requires power control panel.

Combi Model İçin Güç Kontrol Paneli Power Control Panel For Combi Model



KOD CODE	GÜÇ POWER	FİYAT PRICE
21017143009	5-11,5 kW	250 €



Fintech Konforu / Fintech Wellness

Kumanda Panoları & Güç Kontrol Panel

Control Box & Power Control Box

Öne Çıkan Özellikler Product Features

- » 110°C'ye kadar ayarlanabilir termostat
- » Sauna aydınlatma kontrol düğmesi
- » 15 kW üzeri modeller güç kontrol paneli ile kullanılmalıdır
- » Adjustable thermostat up to 110°C
- » Sauna lighting control button
- » Models above 15 kW require power control panel



KOD CODE	POWER GÜÇ	MODEL	FİYAT PRICE
21017143004	3-9 kW Arası 3-9 kW Between	Dijital	175 €
21017143005	10,5-15 kW Arası 10,5-15 kW Between	Dijital	175 €
21017143006	18-30 kW Arası 18-30 kW Between	Dijital	175 €

Dijital ekran, 4 saate kadar timer.
Digital display, timer up to 4 hours.



KOD CODE	POWER GÜÇ	MODEL	FİYAT PRICE
21017143001	3-9 kW Arası 3-9 kW Between	Manuel Manual	125 €
21017143002	10,5-15 kW Arası 10,5-15 kW Between	Manuel Manual	140 €
21017143003	18-30 kW Arası 18-30 kW Between	Manuel Manual	115 €

3 saate kadar timer.
Timer up to 3 hours.



Güç Kontrol Paneli Power Control Panel

KOD CODE	POWER GÜÇ	FİYAT PRICE
21017143007	18-30 kW Arası 18-30 kW Between	300 €

Sauna sobaları için ilave güç kontrol panelleri.
Additional power control panels for sauna heaters.

fin
tech

Sauna Cam Kapısı Security Glass Door for Saunas



KOD CODE	ÖLÇÜ SIZE	FİYAT PRICE
21517143002	185x80x5 cm	355 €
21517143003	207,5x89x5 cm	370 €

Öne Çıkan Özellikler Product Features

- » Dış kasası saunaya uygun üretilmiştir
- » Temperli camı sayesinde ısıya ve darbelere karşı dayanıklıdır
- » Leke tutmazlar
- » Kapı kolu ile beraber teslim edilir
- » The outer casing is made for sauna use.
- » Tempered glass makes it resistant to heat and impact.
- » Stain-resistant.
- » Comes with a door handle.

fin
tech

Sauna Kapısı Ahşap Tutamak Seti Wooden Handle Set for Saunas Door



KOD CODE	FİYAT PRICE
21517143004	46 €

Öne Çıkan Özellikler Product Features

- » Saunaya uygun ahşaptan üretilmiştir
- » Ergonomik tasarımı sayesinde kapıyı kolaylıkla açabilmeyi sağlar
- » Made of sauna-safe wood.
- » Its ergonomic design allows for easy opening of the door.

Ahşap Paneller Wooden Panels

Saunalar için yüksek dayanımlı, düşük reçineli özel ahşap.
High-strength, low-resin special wood for saunas.

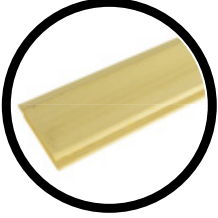

Abachi Lambri Paneli Abachi Wall Panel

KOD CODE	ÖLÇÜ SIZE	FİYAT PRICE
21515142007	2100x85x16 mm	20,50 €
210002048	2200x85x16 mm	21,50 €
210002049	2250x85x16 mm	22,00 €
21515142009	2400x85x16 mm	23,00 €
210002077	2500x85x16 mm	23,50 €
210002022	3000x85x16 mm	25,50 €
210002024	4500x85x16 mm	38,00 €



Abachi Ranzalık Paneli Abachi Sitting Panel

KOD CODE	ÖLÇÜ SIZE	FİYAT PRICE
21516142013	2225x93x18 mm	22,00 €
21516142014	2400x93x18 mm	23,00 €
21516142012	2500x93x18 mm	24,50 €
21516142002	3000x93x18 mm	25,50 €
21516142006	4000x93x18 mm	35,00 €
21516142009	4500x93x18 mm	39,00 €



Fin Ladini Lambri Paneli Spruce Wall Panel

KOD CODE	ÖLÇÜ SIZE	FİYAT PRICE
210143050	2100x95x12 mm	20,50 €

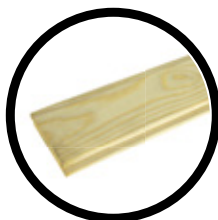

Fin Çamı Lambri Budaksız Paneli Pipe Wall Panel

KOD CODE	ÖLÇÜ SIZE	FİYAT PRICE
21515142001	2400 mm	--
21515142010	3000 mm	--

Sauna Aksesuarları Sauna Accessories

Plastik Termometre
Plastic Thermometer



22015143001 23 €

Neme dayanıklı.
Moisture resistant.

Plastik Higrometre
Plastic Hygrometer



22015143002 21 €

Ahşap Termometre
Wooden Thermometer



22015143003 33 €

Neme dayanıklı.
Moisture resistant.

Ahşap Higrometre
Wooden Hygrometer



22015143004 43 €

Plastik Termo-Higrometre (Birleşik)
Plastic Thermo-Hygrometer (Combined)



22015143005 37 €

Saunadaki sıcaklık ve nemi tek saatte ölçer.
Measures sauna temperature and humidity in one device.

Ahşap Termo-Higrometre (Birleşik)
Wooden Thermo-Hygrometer (Combined)



22015143006 54 €

Saunadaki sıcaklık ve nemi tek saatte ölçer.
Measures sauna temperature and humidity in one device.

Ahşap Kombine Termo-Higro
Wooden Combined Thermo-Hygro



22015143007 70 €

Saunadaki sıcaklık ve nemi ölçer,
her iki cihaz tek ahşap kasada birleşiktir.
Measures sauna temperature and humidity,
both instruments combined in a single wooden
case.

Ahşap Kova
Wooden Bucket



22015143008 45 €

Plastik hazne ahşabı sudan korur.
Plastic liner protects wood from water.

Ahşap Kepçe
Wooden Scoop



22015143009 15 €

Ahşap Aplik Koruma
Wooden Lamp Shade For Sauna



22015143014 26 €

Sauna apliği üzerine takılarak ışığı dekoratif yayar.
Fits on sauna applique to diffuse light
decoratively.

Kum Saati 15 Dk
Sand Timer 15 Mins.



22015143010 38 €

Sauna Saati
Sauna Watch



22015143011 54 €

Sauna Sobası Taşı
Sauna Heater Rock



22015143013	7-10 kg	15 €
22015143012	17-20 kg	27 €

Isı farklarına dayanıklı volkanik taşdır, rezistans üzerine dizilerek dökülen esansı buharlaştırır. Volcanic stone resistant to temperature changes, placed on heating elements to vaporize poured essence.

Sauna Aydınlatma Armatürü
Sauna Light



22015142003	56 €
-------------	------

Dekoratif kafesli saunalara uygun armatür, IP65 korumalı. Lighting fixture suitable for decorative caged sauna, IP65 protected.

Ahşap Yastık
Wooden Pillow



22015143015	32 €
-------------	------

Havalandırma Klapesi
Wooden Ventilation

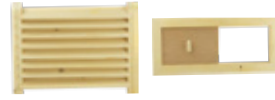

22015143017	Izgaralı Grill	23 €
22015143016	Sürgülü Sliding	23 €

Sauna Esansı
Sauna Parfume



KOD CODE	AMBALAJ PACKING	FİYAT PRICE
22015141004 ÇAM PINE	0,25 lt	12 €
22015141003 ÇAM PINE	1 lt	25 €
22015141001 ÇAM PINE	5 lt	87 €
22015141008 MEYVE FRUIT	0,25 lt	12 €
22015141007 MEYVE FRUIT	1 lt	25 €
22015141014 MEYVE FRUIT	5 lt	87 €
22015141010 LİMON LEMON	0,25 lt	12 €
22015141009 LİMON LEMON	1 lt	25 €
22015141017 LİMON LEMON	5 lt	87 €
22015141012 MENTOL MENTHOL	0,25 lt	12 €
22015141011 MENTOL MENTHOL	1 lt	25 €
22015141013 MENTOL MENTHOL	5 lt	87 €
22015141006 OKALİPTUS EUCALYPTUS	0,25 lt	12 €
22015141005 OKALİPTUS EUCALYPTUS	1 lt	25 €
22015141002 OKALİPTUS EUCALYPTUS	5 lt	87 €

Nem ve rutubet kokusunu önler, hoş koku sağlar, mentol, okaliptus, çam, limon ve meyve sepeti seçenekleri ile. Prevents moisture and damp odors, adds pleasant fragrance, available in menthol, eucalyptus, pine, lemon, and fruit mix options.

FTSG Model Buhar Jeneratörü

Steam Generations FTSG Model

Öne Çıkan Özellikler Product Features

- » Özel boyalı paslanmaz gövde
 - » Mikro bilgisayarlı dijital sıcaklık göstergesi
 - » Enerji tasarruflu güç ayarı
 - » Enerji kesintisi ve su yetersizliğinde otomatik koruma
 - » Otomatik buhar basınç vanası
 - » Aşırı ısınmada güvenlik termostatu
- » Special coated, corrosion-resistant body
 - » Microcomputer digital temperature display
 - » Energy-saving power adjustment
 - » Automatic protection against power failure and low water
 - » Automatic steam pressure release valve
 - » Safety thermostat against overheating



Kontrol Panosu
Control Box



39811143004 3-21 kW 378 €

Buhar Çıkış Ağızı
Inlet For Steam Rooms



39811143005 39 €

KOD CODE	MODEL	GÜÇ POWER	KABİN HACMİ MAX. CABIN VOLUME MAX.	ÖLÇÜLER UxDxG DIMENSIONS LxDxW	FİYAT PRICE
32015143032	FTSG-30	3 kW	2,5 m ³	405 x 410 x 150 mm	1.000 €
32015143031	FTSG-40	4 kW	5 m ³	405 x 410 x 150 mm	1.020 €
32015143030	FTSG-60	6 kW	7 m ³	405 x 410 x 150 mm	1.110 €
32015143029	FTSG-80	8 kW	9 m ³	405 x 410 x 150 mm	1.192 €
32015143028	FTSG-90	9 kW	11 m ³	405 x 410 x 150 mm	1.445 €
32015143027	FTSG-100	10 kW	12 m ³	405 x 410 x 150 mm	1.468 €
32015143026	FTSG-120	12 kW	14 m ³	450 x 425 x 185 mm	1.493 €
32015143025	FTSG-140	14 kW	16 m ³	450 x 425 x 185 mm	1.532 €
32015143024	FTSG-180	18kW	20 m ³	554 x 428 x 185 mm	1.837 €
32015143023	FTSG-210	21 kW	23 m ³	554 x 428 x 185 mm	2.024 €

Deluxe Model Buhar Jeneratörü Steam Generations Deluxe Model

Öne Çıkan Özellikler *Product Features*

- » Şık AISI 316 paslanmaz çelik gövde
- » Mikro bilgisayarlı dijital sıcaklık göstergesi
- » Enerji tasarruflu güç ayarı
- » Enerji kesintisi ve su yetersizliğinde otomatik koruma
- » Otomatik buhar basınç vanası
- » Aşırı ısınmada güvenlik termostati
- » Otomatik su boşaltma özelliği
- » Elegant AISI 316 stainless steel body
- » Microcomputer digital temperature display
- » Energy-saving power adjustment
- » Automatic protection for power failure and low water
- » Automatic steam pressure release valve
- » Internal PCB control against overheating
- » Automatic water drainage feature



Kumanda Panosu Control Box



39811143014 3-21 kW 378 €

KOD CODE	MODEL	GÜÇ POWER	KABİN HACMİ MAX. CABIN VOLUME MAX.	ÖLÇÜLER UxDxG DIMENSIONS LxDxW	FİYAT PRICE
32015143021	DELUXE 6	6 kW	7 m ³	560 × 500 × 225 mm	1.553 €
32015143020	DELUXE 9	9kW	11 m ³	560 × 500 × 225 mm	2.020 €
32015143022	DELUXE 12	12 kW	14 m ³	560 × 500 × 225 mm	2.088 €

Buhar Jeneratörleri Aksesuarları

Steam Generations Accessories

Esans Pompası
Dosing Pump For Esance



39810142001 225 €

Sauna esnasını periyodik olarak dozlayan pompa.
Pump for periodic dosing of sauna essence.

Su Yumuşatma Cihazı
Cabinet Smooting



39811143006 1.350 €

Jeneratöre giren suyu kireçten arındırır.
Removes lime scale from water entering the generator.

Tuz
Salt



59915133010 Tablet 0,40 € / kg

59915133012 Granül Granuler 0,35 € / kg

Yumuşatma cihazı için tablet şeklindedir.
Water softener in tablet form.

Buhar Odası Apliği
Lighting For Steam Rooms



22015142003 56 €

Dekoratif kafesli saunalar için armatür,
IP65 korumalı.
Fixture for decorative caged saunas,
IP65 protected.

Buhar Odası Kapısı
Door For Steam Rooms



39810143003 185x78x6,5 400 €

39810143002 207,5x89x6,5 413 €

Alüminyum dış kasa, temperli cam ile ısıya ve darbe-
ye dayanıklı, kapı kolu ile birlikte teslim edilir,
6 mm cam kalınlığı.
Aluminum outer frame, tempered glass resistant
to heat and impact, delivered with door handle,
6 mm glass thickness.



ÜRÜNLERİMİZ İLE

İŞ ORTAKLARINIZA

MÜKEMMEL VE SORUNSUZ ÇALIŞAN

SAUNA VE BUHAR ODALARI

TESLİM EDİN!

SÜS HAVUZU EKİPMANLARI FOUNTAIN EQUIPMENT

SÜS HAVUZU ÜRÜNLERİ FOUNTAIN PRODUCTS

*Süs Havuzlarına Profesyonel Dokunuş
Professional Touch to Ornamental Pools*

Mimari Projelere Değer Katan Ekipmanlar.
Equipment That Adds Value to Architectural Projects.

Fiskiye nozulları, pompalar, su perdeleri ve dekoratif aydınlatmalarla her projeye teknik verimlilik ve estetik bütünlük sağlıyoruz.

We provide technical efficiency and aesthetic integrity to every project with fountain nozzles, pumps, water curtains and decorative lighting.

Fıskiye Nozulları Fountain Nozzles

Köpük Nozul Foam Nozzle

AISI 304 paslanmaz çelik gövde
Yoğun köpük etkisi
Su seviyesine bağlı çalışma
AISI 304 stainless steel body
Intense foam effect
Operates depending on water level



KOD CODE	BAĞLANTI CONNECTION	FİYAT PRICE
17516132002	3510E-DB 1"	--
17516132032	5510E-DB 1"	--
17516132003	5515E-DB 1 ½"	--
17516132004	7520T-DB 2"	--

Köpük Nozul Foam Nozzle

AISI 304 paslanmaz çelik gövde
Yoğun köpük etkisi
Su seviyesine bağlı çalışma
AISI 304 stainless steel body
Intense foam effect
Operates depending on water level



KOD CODE	BAĞLANTI CONNECTION	FİYAT PRICE
17516123001	1"	--
17516123002	1 ½"	--
17516123003	2"	--

Cascade Nozul Cascade Nozzle

AISI 304 paslanmaz çelik gövde
Köpüklü konik su görüntüsü
Su seviyesine bağlı çalışma
AISI 304 stainless steel body
Foamy conical water pattern
Operates depending on water level



KOD CODE	BAĞLANTI CONNECTION	FİYAT PRICE
17516132005	1"-50T	--
17516132006	1 ½"-70T	--
17516132007	2"-90T	--
17516132008	2 ½"-110T	--
17516132009	3"-130T	--

Cascade Nozul Cascade Nozzle

Pirinçten üretilmiştir
Yoğun köpük etkisi
Su seviyesine bağlı çalışma
Brass body
Intense foam effect
Operates depending on water level



KOD CODE	BAĞLANTI CONNECTION	FİYAT PRICE
17516123004	1"	--
17516123005	1 ½"	--
17516123006	2"	--
17516123007	2 ½"	--

Komet Jet Oynar Başlı Nozul Comet Jet Adjustable Nozzle

AISI 304 paslanmaz çelik gövde
Kararlı, tam akışlı su görüntüsü
Su seviyesinden bağımsız çalışma

AISI 304 stainless steel body
Steady, full-flow water display
Independent of water level operation



KOD CODE	BAĞLANTI CONNECTION	FİYAT PRICE
17516132015	3/8"	--
17516132016	1/2"	--
17516132017	1"	--
17516132018	1 1/2"	--

Şemsiye Fıskiye Nozul Water Bell Nozzle

AISI 304 paslanmaz çelik gövde
Şeffaf şemsiye formunda su görüntüsü
Su seviyesinden bağımsız çalışma

AISI 304 stainless steel body
Transparent umbrella-shaped water display
Independent of water level operation



KOD CODE	BAĞLANTI CONNECTION	FİYAT PRICE
17516132019	1/2"-25-5 T	--
17516132020	1"-30-10T	--
17516132021	1"-45-10T	--
17516132022	1"-60-10T	--

Şemsiye Fıskiye Nozul Brass Water Bell Nozzle

Pirinç gövde
Şeffaf şemsiye formunda su görüntüsü
Su seviyesinden bağımsız çalışma

Brass body
Transparent umbrella-shaped water display
Independent of water level operation



KOD CODE	BAĞLANTI CONNECTION	FİYAT PRICE
17516123012	1"	--
17516123013	1 1/2"	--
17516123014	2"	--

Komet Jet Oynar Başlı Nozul Comet Jet Adjustable Nozzle

Pirinç gövde
Kararlı, tam akışlı su görüntüsü
Su seviyesinden bağımsız çalışma

Brass body
Steady, full-flow water display
Independent of water level operation



KOD CODE	BAĞLANTI CONNECTION	FİYAT PRICE
17516123008	1/2"	--
17516123009	3/4"	--
17516123010	1"	--

Komet Jet Oynar Başlı Nozul Comet Jet Adjustable Nozzle

Pirinç gövde
Kararlı, tam akışlı su görüntüsü
Su seviyesinden bağımsız çalışma

Brass body
Steady, full-flow water display
Independent of water level operation



KOD CODE	BAĞLANTI CONNECTION	FİYAT PRICE
17516123011	1 1/2"	--

Yarım Şemsiye Fıskiye Nozul Half Water Bell Nozzle

Pirinç gövde
Şeffaf şemsiye formunda su görüntüsü
Su seviyesinden bağımsız çalışma

Brass body
Transparent umbrella-shaped water display
Independent of water level operation



KOD CODE	BAĞLANTI CONNECTION	FİYAT PRICE
17516123015	3/4"	--
17516123016	1 1/2"	--
17516123017	2"	--

Yelpaze Nozul Finger Nozzle

AISI 304 paslanmaz çelik gövde
Parmaklardan açılı su püskürtme
Su seviyesinden bağımsız çalışma

AISI 304 stainless steel body
Angled water spray from fingers
Independent of water level operation



KOD CODE	BAĞLANTI CONNECTION	FİYAT PRICE
17516132023	1"-13-4T	--
17516132024	1"-25-4T	--

Film Yelpaze Nozul Fan Jet Nozzle

AISI 304 paslanmaz çelik gövde
Belirli açılı su püskürtme
Su seviyesinden bağımsız çalışma

AISI 304 stainless steel body
Angled water spray
Independent of water level operation



KOD CODE	BAĞLANTI CONNECTION	FİYAT PRICE
17516132025	½"	--
17516132026	2"	--

Gonca Nozul Bud Nozzle

Pirinç gövde
Çiçek yaprağı formunda su görüntüsü
Su seviyesinden bağımsız çalışma

Brass body
Flower-petal water pattern
Independent of water level operation



KOD CODE	BAĞLANTI CONNECTION	FİYAT PRICE
17516123022	1"	--
17516123023	2"	--

Yelpaze Nozul Finger Nozzle

Pirinç gövde
Parmaklardan açılı su püskürtme
Su seviyesinden bağımsız çalışma

Brass body
Angled water spray from fingers
Independent of water level operation



KOD CODE	BAĞLANTI CONNECTION	FİYAT PRICE
17516123018	½"-25-5 T	--
17516123019	1"-30-10T	--

Volkan Nozul Volcano Nozzle

AISI 304 paslanmaz çelik gövde
Komet nozullarla ayarlanabilir jet açıları
Farklı yükseklik ve genişliklerde kademeli su
görüntüsü

AISI 304 stainless steel body
Adjustable jet angles with comet nozzles
Tiered water display at various heights and widths



KOD CODE	BAĞLANTI CONNECTION	FİYAT PRICE
17516132027	1"-19-3T	--
17516132028	1"-43-3T	--
17516132029	2"-200-19-6T	--
17516132030	2 ½"-300-19-8T	--

Volkan Nozul Volcano Nozzle

Pirinç gövde
Komet nozullarla ayarlanabilir jet açıları
Farklı yükseklik ve genişliklerde kademeli su görüntüsü
Su seviyesinden bağımsız çalışma

Brass body
Adjustable jet angles with comet nozzles
Tiered water display at various heights and widths
Independent of water level operation



KOD CODE	BAĞLANTI CONNECTION	FİYAT PRICE
17516123024	1"-13-4T	--
17516123025	1"-25-4T	--

Papatya Nozul Daisy Nozzle

Pirinç gövde
Komet nozullarla ayarlanabilir jet açıları
Çiçek formunda kademeli su görüntüsü
Su seviyesinden bağımsız çalışma

Brass body
Adjustable jet angles with comet nozzles
Flower-shaped tiered water display
Independent of water level operation



KOD CODE	BAĞLANTI CONNECTION	FİYAT PRICE
17516123026	1 ½"	--
17516123027	2"	--

Çiçek Nozul Flower Nozzle

Pirinç gövde
Farklı yükseklik ve genişliklerde kademeli su görüntüsü
Ayarlanabilir su yönü
Su seviyesinden bağımsız çalışma

Brass body
Tiered water display at various heights and widths
Adjustable water direction
Independent of water level operation



KOD CODE	BAĞLANTI CONNECTION	FİYAT PRICE
17516123028	1 ½"	--
17516123029	2"	--

Su Topacı Nozul Water Spinner Nozzle

Pirinç gövde, paslanmaz çelik kollar
Döner spiral su görüntüsü
Su seviyesinden bağımsız çalışma

Brass body, stainless steel arms
Rotating spiral water display
Independent of water level operation



KOD CODE	BAĞLANTI CONNECTION	FİYAT PRICE
17516123030	1"-31 K	--
17516123031	1 ½"-41 K	--

Su Küresi Nozul Water Sphere Nozzle

Pirinç gövde, paslanmaz çelik kollar
Etkileyici su görüntüsü
Su seviyesinden bağımsız çalışma

Brass body, stainless steel arms
Impressive water display
Independent of water level operation



KOD CODE	BAĞLANTI CONNECTION	FİYAT PRICE
17516123032	Ø 60 cm 1"	--
17516123033	Ø 70 cm 1 ½"	--
17516123034	Ø 100 cm 2"	--
17516123035	Ø 150 cm 3"	--

Yıldız Fıskiye Nozul Star Nozzle

AISI 304 paslanmaz çelik gövde
Yıldız şeklinde su görüntüsü
Su seviyesinden bağımsız çalışma

AISI 304 stainless steel body
Star-shaped water display
Independent of water level operation



KOD CODE	BAĞLANTI CONNECTION	FİYAT PRICE
17516132031	1 ½" -12 K	--

Yıldız Fıskiye Nozul Star Nozzle

Pirinç gövde, paslanmaz çelik kollar
Yıldız şeklinde su görüntüsü
Su seviyesinden bağımsız çalışma

Brass body, stainless steel arms
Star-shaped water display
Independent of water level operation



KOD CODE	BAĞLANTI CONNECTION	FİYAT PRICE
17516123036	1 ½" -8 K	--
17516123037	2" - 8 K	--

Süs Havuzu Lambaları

Fountain Pools Light

Ledli Lambalar Led Lights

Öne Çıkan Özellikler Product Features

- » AISI 304 monoblok paslanmaz gövde, polikarbonat armatür camı
- » AISI 304 monoblock stainless steel body, polycarbonate fixture glass
- » IP68 koruma
- » IP68 protection
- » Lamba ayakları fiyata dahil değildir
- » Lamp feet not included
- » Opsiyonel lamba standı ve AISI 316 seçeneği
- » Optional lamp stand and AISI 316 version available



KOD CODE	MODEL	GÜÇ POWER	ÇAP DIA	FİYAT PRICE
12519002017	1) 3 POWERLED	3W/12-24V IP 68	105 mm	59 €
12519002005	2) 6 POWERLED	6W/12-24V IP 68	105 mm	85 €
12519002021	3) 9 POWERLED	9W/12-24V IP 68	137 mm	90 €
12519002022	4) 12 POWERLED	12W/12-24V IP 68	137 mm	100 €
12519002018	5) 15 POWERLED	15W/12-24V IP 68	197,5 mm	112 €
12519002019	6) 18 POWERLED	18W/12-24V IP 68	197,5 mm	126 €

Halka Süs Havuzu Lambalar Ring Fountain Led Lights

Öne Çıkan Özellikler Product Features

- » Monoblok paslanmaz gövde, polikarbonat armatür camı
- » Monoblock stainless steel body, polycarbonate fixture glass
- » IP68 koruma
- » IP68 protection
- » Opsiyonel fıskiye nozulu montajı
- » Optional fountain nozzle installation
- » Nozullar görsel amaçlıdır, fiyata dahil değildir
- » Nozzles shown for visual purposes, not included in price
- » Uyumlu nozullar yukarıda listelenmiştir
- » Compatible nozzles are listed above



KOD CODE	MODEL	RENK COLOR	GÜÇ POWER	ÇAP DIA	FİYAT PRICE
12519122080	1) 6 POWERLED 6 POWERLED	Beyaz White	6W/12-24V IP 68	105 mm	150 €
12519122111	2) 9 POWERLED 9 POWERLED	Beyaz White	9W/12-24V IP 68	137 mm	195 €
12519122075	2) 12 POWERLED 12 POWERLED	Beyaz White	12W/12-24V IP 68	198 mm	210 €
12519002020	3) 18 POWERLED 18 POWERLED	Beyaz White	18W/12-24V IP 68	198 mm	230 €
17517124001	1) 6 POWERLED 6 POWERLED	RGB	6 kW RGB	105 mm	--
12519002019	2) 9 POWERLED 9 POWERLED	RGB	9 kW RGB	137 mm	--
12519122098	2) 12 POWERLED 12 POWERLED	RGB	12 kW RGB	198 mm	--
17517124002	3) 189 POWERLED 18 POWERLED	RGB	18 kW RGB	198 mm	--

Su Perdeleri Water Curtain

Kobra Model *Cobra Model*



KOD CODE	MODEL	ÖLÇÜ SIZE	FİYAT PRICE
AISI 304 PASLANMAZ ÇELİK			
17518122008	Mini Bali	475 x 350 mm	550 €
17518122009	Bali	500 x 700 mm	660 €
17518122006	Bali	600 x 800 mm	880 €
AISI 316 PASLANMAZ ÇELİK			
17518122003	Mini Bali	475 x 350 mm	620 €
17518122001	Bali	500 x 700 mm	880 €
17518122005	Bali	600 x 800 mm	1.050 €

Maui Model *Maui Model*



KOD CODE	MODEL	FİYAT PRICE
AISI 304 PASLANMAZ ÇELİK		
17518123003	MAUI 300	445 €
17518123004	MAUI 500	555 €
17518122004	MAUI 1.000	1.200 €

Salyangoz Model *Snail Model*



KOD CODE	MODEL	ÖLÇÜ SIZE	BAĞLANTI CONNECTION	FİYAT PRICE
AISI 304 PASLANMAZ ÇELİK				
17518122019	Salyangoz <i>Snail</i>	350x600 mm	63 mm	630 €
17518122015	Salyangoz <i>Snail</i>	400x600 mm	63 mm	675 €
17518122016	Salyangoz <i>Snail</i>	400x800 mm	63 mm	765 €
17518122020	Salyangoz <i>Snail</i>	400x1000 mm	63 mm	865 €
AISI 316 PASLANMAZ ÇELİK				
17518122021	Salyangoz <i>Snail</i>	350x600 mm	63 mm	665 €
17518122017	Salyangoz <i>Snail</i>	400x600 mm	63 mm	710 €
17518122018	Salyangoz <i>Snail</i>	400x800 mm	63 mm	795 €
17518122022	Salyangoz <i>Snail</i>	400x1000 mm	63 mm	895 €

Yunus Model *Dolphin Model*



KOD CODE	MODEL	ÖLÇÜ SIZE	BAĞLANTI CONNECTION	FİYAT PRICE
AISI 304 PASLANMAZ ÇELİK				
17518122023	Yunus <i>Dolphin</i>	350x500 mm	50 mm	475 €
17518122024	Yunus <i>Dolphin</i>	400x600 mm	63 mm	555 €
17518122025	Yunus <i>Dolphin</i>	400x800 mm	63 mm	630 €
AISI 316 PASLANMAZ ÇELİK				
17518122026	Yunus <i>Dolphin</i>	350x500 mm	50 mm	555 €
17518122027	Yunus <i>Dolphin</i>	400x600 mm	63 mm	630 €
17518122028	Yunus <i>Dolphin</i>	400x800 mm	63 mm	710 €

Senkron Smartline Fıskiye Pompası

Senkron Smartline Fountain Pump

DEKORATİF AKIŞ

DECORATIVE FLOW

Korozyona dayanıklı seramik mil ve yüksek verimli senkron motoru ile süs havuzlarında uzun ömürlü, güvenilir ve estetik su akışı sağlar..

With a corrosion-resistant ceramic shaft and high-efficiency synchronous motor, it delivers long-lasting, reliable, and aesthetic water flow for decorative fountains.

10 MT KABLO
CABLE 10 MT

IP X8

35°



Öne Çıkan Özellikler

Product Features

- » Korozyona dayanıklı seramik mil, tatlı ve deniz suyuna uygun
- » Canlı parçalar su geçirmez haznede yüksek yalıtımla korunur
- » Aşırı akım ve ısınma korumalı, yüksek verimli senkron motor
- » Devrilebilir rotor pervane yapısı ile güvenli ve bakımı kolay
- » Kolay sökülebilir tasarım sayesinde zahmetsiz temizlik
- » Corrosion-resistant ceramic shaft, suitable for fresh and sea water
- » Moving parts sealed in a waterproof, highly insulated chamber
- » High-efficiency synchronous motor with overcurrent and overheating protection
- » Tiltable rotor impeller design for safety and easy maintenance
- » User-friendly design allows effortless disassembly and cleaning



KOD CODE	GÜÇ POWER	DEBİ FLOW MAX	BASMA YÜKSEKLİĞİ HEAD MAX	ÇIKIŞ OUTLET	AĞIRLIK WEIGHT	FİYAT PRICE
19810123071	6W	350L/H	0,8 m	13 m	11 kg	42 €
19810123072	12W	750L/H	1,5 m	13 m	12,5 kg	53 €
19810123090	35W	2000L/H	3 m	1 / 2"	20 kg	82 €
19810123091	55W	3000L/H	3,5 m	1 / 2"	22,6 kg	110 €
19810123075	85W	5000L/H	4,5 m	1"	22,6 kg	250 €
19810123076	105W	6000L/H	5,2 m	1"	23 kg	270 €





BAHÇE & GÖLET EKİPMANLARI GARDEN & POND EQUIPMENT

BAHÇE VE GÖLET ÜRÜNLERİ GARDEN AND POND PRODUCTS

*Ekolojik göletlerde güvenilir uygulama
Safe application in ecological ponds*

Ekolojik Çözümler.
Ecological Solutions.

Doğayla uyumlu ekipmanlarımızla sürdürülebilir projeler geliştirin.
Develop sustainable projects with our eco-friendly equipment.

Gölet Filtresi Pond Filter

GÜVENLİ FİLTRASYON RELIABLE FILTRATION

Yüksek kapasiteli biyolojik filtreleme ile gölet projelerinizde temiz ve sürdürülebilir su kalitesi sağlar.

Delivers high-capacity biological filtration, ensuring clean and sustainable water quality in your pond projects.



Öne Çıkan Özellikler Product Features

- » 90.000 litreye kadar bahçe havuzları için uygundur
- » 180 litrelik kapasite, 3 bölmeli yapısıyla güvenilir su temizliği sağlar
- » 8 kaba, 4 ince filtre ve 3 Japon filtre matı ile donatılmıştır
- » Havuz kıyısına yerleştirilir, uygun pompa ile bağlanır (pompa dahil değildir)
- » Suitable for garden ponds up to 90,000 litres
- » 180-litre capacity with 3 chambers ensures reliable water purification
- » Equipped with 8 coarse filters, 4 fine filters, and 3 Japanese filter mats
- » Installed on the pond bank and connected with a suitable pump (pump not included)



Önemli Noktalar

- **Pratik Kontrol:** Toprak göstergesi ve sıcaklık ölçer ile kullanım kolaylığı
- **Kolay Bakım:** Kaba kir tahliyesi ve basit basma sistemiyle filtre temizliği zahmetsiz
- **Yüksek Performans:** Büyük su akışı kapasitesiyle geniş göletler için ideal
- **Çeşitli Filtreleme:** Özel sünger ve Japon filtresiyle etkin biyolojik arıtım

Highlights

- **Easy Monitoring:** Soil indicator & temperature display for effortless control
- **Easy Maintenance:** Dirt drain & push system for hassle-free cleaning
- **High Performance:** Large water flow capacity, ideal for bigger ponds
- **Versatile Filtration:** Special sponge & Japanese mat for effective biological treatment

KOD CODE	DEBİ FLOW	BALIKLI GÖLET POND WITH FISH	DEKORATİF GÖLET NORMAL POND	UV-C BAĞLANTI CONNECTION UV-C	ÜRÜN BOYUTU ITEM SIZE	FİYAT PRICE
GAR202310001	1200LPH	45 m ³	90 m ³	PUV236	1280x540x400 mm	1.765 €

Gölet Filtresi Pond Filter

BASINÇLI FİLTRASYON PRESSURIZED FILTRATION

UV-C arıtma teknolojisi ve basınçlı pompa performansı ile gölet projelerinizde maksimum temizlik ve verimlilik sağlar.

Delivers maximum cleaning efficiency in your pond projects with UV-C purification technology and pressure pump performance.



Öne Çıkan Özellikler Product Features

- » UV-C arıtma teknolojisi ve optimum akış hızıyla yüksek kaliteli filtrasyon
- » Özel sünger ve Japon filtre malzemeleriyle etkin biyolojik temizlik
- » Kanister kapak yapısı sayesinde kolay montaj ve bakım
- » Basınçlı pompa performansı ile şelale gibi üst seviye uygulamalara uygun
- » High-quality filtration with UV-C purification technology and optimum flow rate
- » Effective biological cleaning with special sponges and Japanese filter media
- » Easy installation and maintenance with canister lid design
- » Suitable for advanced applications like waterfalls thanks to pressure pump performance

KOD CODE	DEBİ FLOW	BALIKLI GÖLET POND WITH FISH	DEKORATİF GÖLET NORMAL POND	UV GÜCÜ BULB POWER	KAPASİTE TANK CAPACITY	ÜRÜN BOYUTU ITEM SIZE	FİYAT PRICE
GAR202310011	6000 L/h	3 m ³	6 m ³	11 W	16 lt	310x310x405 mm	505 €
GAR202310012	10000 L/h	6 m ³	12 m ³	11 W	25 lt	380x380x520 mm	800 €
GAR202310013	10000 L/h	15 m ³	30 m ³	18 W	38 lt	380x380x730 mm	930 €



KOD CODE	DEBİ FLOW	BALIKLI GÖLET POND WITH FISH	DEKORATİF GÖLET NORMAL POND	UV GÜCÜ BULB POWER	KAPASİTE TANK CAPACITY	ÜRÜN BOYUTU ITEM SIZE	FİYAT PRICE
GAR202310015	14000 LPH	30 m ³	60 m ³	55 W	75 lt	450x450x725 mm	1.875 €
GAR202310014	20000 LPH	50 m ³	100 m ³	55 W	300 lt	750x750x890 mm	4.750 €

UV Dezenfeksiyon

UV Disinfection

UV GÜVENCESİ

UV ASSURANCE

UVC ışık teknolojisiyle gölet projelerinizde yosun ve bakterilere karşı güvenilir dezenfeksiyon sağlar.

Provides reliable disinfection in your pond projects with UVC light technology against algae and bacteria.



Öne Çıkan Özellikler

Product Features

- » PL lamba UVC radyasyonu ile zararlı bakteri ve mikropları yok eder
- » 14 gün içinde temiz ve berrak su sağlar
- » Yosun oluşumunu kontrol altına alır
- » Biyolojik filtre ile birlikte kullanıldığında en iyi sonuç alınır
- » Eliminates harmful bacteria and germs with PL lamp UVC radiation
- » Ensures clear and clean water within 14 days
- » Controls algae growth effectively
- » Achieves best results when combined with a biological filter

Önemli Noktalar

- **Balık ve Bitki Koruması:** Mikroplara karşı güvenli ortam sağlar
- **Doğal Temizlik:** Kimyasal madde ekmeden suyu arındırır
- **Yosun Kontrolü:** Yosun, bakteri ve küf oluşumunu önler
- **Kolay Bağlantı:** Evrensel hortum adaptörleriyle pratik kurulum

Highlights

- **Fish & Plant Safety:** Creates a secure environment against germs
- **Natural Purification:** Cleans pond water without chemicals
- **Algae Control:** Prevents algae, bacteria and mould growth
- **Easy Connection:** Quick installation with universal hose fittings



KOD CODE	GÜÇ DEĞERİ RATED POWER	UV LAMBA GÜCÜ UV LAMP POWER/FISH	KAPASİTE CAPACITY	BASINÇ MAX PRESSURE	DEBİ MAX FLOW	GİRİŞ ÇIKIŞ ADAPTÖRÜ INLET&OUTLET ADAPTER	FİYAT PRICE
GAR202310002	40 W	45 m³	90 m³	0.3 bar	6000 L/h	3/4"-1-1/2"	250 €

Dalgıç Pompa Submersible Pump

ENERJİ TASARRUFU ENERGY SAVING

Gölet projelerinizde sürekli çalışmaya uygun, yüksek verimlilikte tasarımıyla bütçenize katkı sağlar.

With high-efficiency design for continuous operation, it contributes to your budget in pond projects.



Öne Çıkan Özellikler Product Features

- » Gölet pazarındaki en yüksek verimlilikteki pompalar arasında yer alır
- » Diğer havuz pompalarına kıyasla dikkat çekici enerji tasarrufu sağlar
- » Enerji verimliliği ön planda tasarlanmış olup sürekli çalışması gereken sistemlerde her watt tasarrufuyla bütçeye katkıda bulunur
- » Among the most efficient pumps in the pond market
- » Provides remarkable energy savings compared to other pool pumps
- » Designed with energy efficiency in mind, saving every watt in systems requiring continuous operation

Örnek Hesaplama

Bu pompalar 5 watt daha az tüketimle yılda yaklaşık 43,8 kWh enerji tasarrufu sağlar.

- **Esnek Kullanım:** Filtre besleme pompası olarak kullanılabilirdiği gibi, emiş tarafında bir skimmer çalıştırmak için de uygundur.
- **Pratik Çözüm:** Harici emiş bağlantısı kullanılmadığında boş tapa ile kapatılabilir.
- **Y-Adaptör Kullanımı:** Güçlü pompa debisi sayesinde, adaptörle birlikte taşma riskini önler, ek akış sağlar ve başka bir artııcı ya da filtreyi besleyebilir.
- **Bahçe ve Bitki Göletleri:** Balıksız göletlerde dahi suyun oksijen seviyesini artırmak için günlük sirkülasyon önerilir.

Sample Calculation

These pumps save approx. 43.8 kWh annually with 5 watts less consumption.

- **Flexible Use:** Can operate as a filter feed pump or drive a skimmer on the suction side.
- **Practical Solution:** The external suction connection can be sealed with a blank cap when not in use.
- **Y-Adapter Usage:** With powerful flow, prevents filter overflow, provides additional flow, and can operate another purifier or filter.
- **Garden & Plant Ponds:** Even in fishless ponds, daily circulation is recommended to enrich water oxygen levels and keep it moving.

Kullanıcı yorumunu izlemek için QR kodu okutun.

Scan the QR code to view user comments.



KOD CODE	GÜÇ POWER	MAX ATIŞ MAX HEAD	DEBİ MAX FLOW	ÖLÇÜ DIMENSIONS	FİYAT PRICE
GAR202310016	40w	4.2 m	6000 L/h	240x200x135 mm	283 €
GAR202310003	80w	6.0 m	10000 L/h	280x240x140 mm	322 €
GAR202310017	100w	6.5 m	12000 L/h	280x240x140 mm	340 €
GAR202310018	120w	7.0 m	14000 L/h	280x240x140 mm	565 €

Dalgıç Pompa Submersible Pump

TAMAMEN SU GEÇİRMEZ MOTOR SEALED & WATERPROOF

Tamamen sızdırmaz ve su geçirmez motoru ile uzun ömürlü ve güvenilir kullanım sağlar.

Ensures long-lasting and reliable operation with its fully sealed and waterproof motor.



Öne Çıkan Özellikler Product Features

- » Özel rotor malzemesiyle uzun ömürlü kullanım
- » Kolay çalıştırma ve düşük enerji tüketimi
- » Dayanıklı gövde, sessiz çalışma
- » Tamamen sızdırmaz ve su geçirmez motor
- » Yeni tasarımı asenkron motor ile %50'ye varan enerji tasarrufu
- » Long-lasting use with special rotor material
- » Easy start-up and low energy consumption
- » Durable body with quiet operation
- » Fully sealed and waterproof motor
- » Up to 50% energy saving with redesigned asynchronous motor



Önemli Noktalar

- **Özel Rotor:** Dayanıklı malzemesiyle uzun ömürlü kullanım sağlar
- **Enerji Tasarrufu:** Yeni nesil asenkron motor ile %50'ye varan enerji verimliliği
- **Sessiz Çalışma:** Düşük gürültü seviyesiyle konforlu kullanım
- **Su Geçirmez Motor:** Tamamen sızdırmaz yapıyla güvenilir performans
- **Dayanıklı Yapı:** Uzun süreli projeler için güvenilir çözüm

Highlights

- **Special Rotor:** Long-lasting use with durable material
- **Energy Saving:** Up to 50% efficiency with redesigned asynchronous motor
- **Quiet Operation:** Comfortable use with low noise level
- **Waterproof Motor:** Reliable performance with fully sealed design
- **Durable Structure:** Trusted solution for long-term projects

KOD CODE	GÜÇ DEĞERİ RATED POWER	MAX ATIŞ MAX HEAD	DEBİ MAX FLOW	HORTUM ADAPTÖR DIMENSIONS	SERTİFİKA CERTIFICATE	FİYAT PRICE
GAR202310019	175 w	8.5 m	18000 L/H	1"-1-1/4"-1-1/2"-2"	CE / GS	480 €

Dalgıç Fıskiye Pompası Pond Pump

TEMİZ SİRKÜLASYON CLEAN CIRCULATION

Sürekli ve güvenilir su dolaşımı sağlayarak gölet projelerinizde optimum biyolojik temizlik sunar.

Ensures continuous and reliable water circulation, providing optimal biological cleaning in your pond projects.



Öne Çıkan Özellikler Product Features

- » Havuz temizliği için gerekli tüm işlevleri sunar
- » Entegre pompa ile sürekli ve güvenilir su sirkülasyonu sağlar
- » Teslimat içeriğindeki aksesuarlarla havuz veya fıskiye pompası olarak kullanılabilir
- » Ek filtre sünger ve 3 filtre aşaması sayesinde optimum biyolojik temizlik sağlar
- » Provides all essential functions for pond cleaning
- » Integrated pump ensures continuous and reliable water circulation
- » Can be used as pond or fountain pump with included accessories
- » Additional filter sponge and 3 filter stages deliver optimal biological cleaning

Filtre Malzemesi

- Polar, floss veya sünger gibi modern filtre malzemeleri akvaryumculukta önemlidir
- Kaba kir parçacıkları filtre ipliğiyle tutulur, süngerler nitratı azaltır
- Su kimyasal kirliliklerden arındırılır, filtre bakterilerinin yerleşimi için ideal koşullar sağlanır

Filter Media

- Filter media such as polar, floss or sponges are essential in modern aquatics
- Coarse dirt particles are captured by filter floss, sponges reduce nitrate
- Water is purified from chemical impurities, creating ideal conditions for filter bacteria settlement

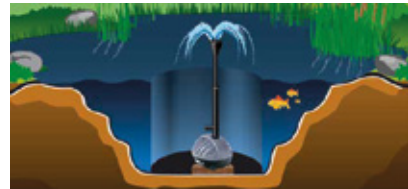

KOD CODE	GÜÇ POWER	UV-C LAMBA UV-C LAMP	KAPASİTE CAPACITY	MAX ATIŞ MAX HEAD	DEBİ MAX FLOW	ÖLÇÜ DIMENSIONS	FİYAT PRICE
GAR202310007	28 W	9 W	2500 L	1.6 m	1000 L/h	316x251x135 mm	200 €
GAR202310006	45 W	11 W	4000 L	2 m	2000 L/h	387x275x136 mm	226 €

Senkron Smartline Fıskiye Pompası

Senkron Smartline Fountain Pump

DEKORATİF AKIŞ

DECORATIVE FLOW

Korozyona dayanıklı seramik mil ve yüksek verimli senkron motoru ile ss havuzlarında uzun mrl, gvenilir ve estetik su akıřı saęlar..

With a corrosion-resistant ceramic shaft and high-efficiency synchronous motor, it delivers long-lasting, reliable, and aesthetic water flow for decorative fountains.

10 MT KABLO
CABLE 10 MT

IP X8

35°



ne Çıkan zellikler

Product Features

- » Korozyona dayanıklı seramik mil, tatlı ve deniz suyuna uygun
- » Canlı parçalar su geçirmez haznede yüksek yalıtımla korunur
- » Ařırı akım ve ısınma korumalı, yüksek verimli senkron motor
- » Devrilebilir rotor pervane yapısı ile gvenli ve bakımı kolay
- » Kolay sklebilir tasarımı sayesinde zahmetsiz temizlik

- » Corrosion-resistant ceramic shaft, suitable for fresh and sea water
- » Moving parts sealed in a waterproof, highly insulated chamber
- » High-efficiency synchronous motor with overcurrent and overheating protection
- » Tiltable rotor impeller design for safety and easy maintenance
- » User-friendly design allows effortless disassembly and cleaning



KOD CODE	GÇ POWER	DEBİ FLOW MAX	BASMA YKSEKLİęİ HEAD MAX	ÇIKIř OUTLET	AęIRLIK WEIGHT	FİYAT PRICE
19810123071	6W	350L/H	0,8 m	13 m	11 kg	42 €
19810123072	12W	750L/H	1,5 m	13 m	12,5 kg	53 €
19810123090	35W	2000L/H	3 m	1 / 2"	20 kg	82 €
19810123091	55W	3000L/H	3,5 m	1 / 2"	22,6 kg	110 €
19810123075	85W	5000L/H	4,5 m	1"	22,6 kg	250 €
19810123076	105W	6000L/H	5,2 m	1"	23 kg	270 €

Dalgıç Pompalar Submersible Pumps

senkron^{SMART}

Marka / Brand
Neta Havuz Ürünü / Neta Pool Product

Senkron Smart

Öne Çıkan Özellikler Product Features

- » Aşırı ısınma koruma rölesi ile güvenli ve güvenilir çalışma
- » Gizli flatör
- » 10 m³/h debi
- » Bakır sargı elektrik motoru
- » Kirden sıkışmayan flatör sistemi
- » Tek kademeli
- » Safe and reliable operation with overheat protection relay
- » Hidden floater
- » Flow rate of 10 m³/h
- » Copper wounded electric motor
- » Floater system not jammed from dirt
- » Single stage

Kullanım kılavuzuna ulaşmak için QR kodu okutun.

Scan the QR code to access the user manual.



KOD CODE	ÜRÜN ADI NAME	GÜÇ POWER	DEBİ L/H FLOW L/H	BASMA YÜKSEKLİĞİ HEAD	KABLO CABLE	VOLTAJ VOLTAGE	FİYAT PRICE
19810123080	Dalgıç Pompa Submersible Pump	550W	10.000	8,5 mt	10 mt	220V/50Hz	110 €
11516262039	Havuz Örtüsü Dalgıç Pompası Submersible Pump for Pool Cover	0,55 kW	10.000	8,5 mt	10 mt	220V/50Hz	150 €

TRIONE

Trione

Öne Çıkan Özellikler Product Features

- » Aşırı ısınma koruma rölesi ile güvenli ve güvenilir çalışma
- » Gizli flatör
- » 10 m³/h debi
- » Alüminyum sargı elektrik motoru ve dolayısıyla piyasanın en uygun fiyatlı dalgıç pompası
- » Tek kademeli
- » Safe and reliable operation with overheat protection relay
- » Hidden floater
- » Flow rate of 10 m³/h
- » Aluminum wounded Electric motor with the most affordable submersible pump on the market
- » Single stage

Kullanım kılavuzuna ulaşmak için QR kodu okutun.

Scan the QR code to access the user manual.



KOD CODE	GÜÇ POWER	DEBİ L/H FLOW L/H	BASMA YÜKSEKLİĞİ HEAD	KABLO CABLE	VOLTAJ VOLTAGE	FİYAT PRICE
19810123081	550W	10.500	8 mt	10 mt	220V/50Hz	90 €

Solar Duşlar Ayak Yıkamalı Solar Shower With Foot Wash

Öne Çıkan Özellikler Product Features

- » Solar duş seti, 20, 35 ve 40 litrelik su haznesi ve dış mekâna uygun siyah-gümüş tasarımıyla verimli bir çözüm sunar
 - » Büyük yağmur başlığı ideal yükseklikte konumlandırılmıştır
 - » Kademesiz sıcaklık ayarı rahat sıcaklık kontrolü sağlar
 - » Tek kollu musluk ve ayak yıkama musluğu kolay kullanım sunar
 - » 2 yıl garantilidir
- » The solar shower set offers an efficient solution with a 20, 35 and 40-liter water tank and outdoor-friendly black-silver design
 - » Large rain head positioned at optimal height
 - » Stepless temperature control for easy adjustment
 - » Single-lever faucet and foot-wash faucet for convenient use
 - » 2 years warranty

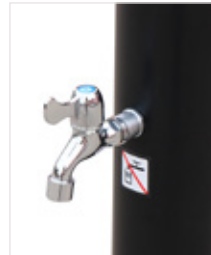
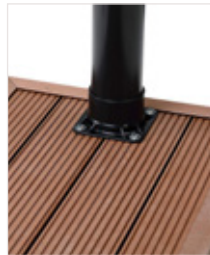
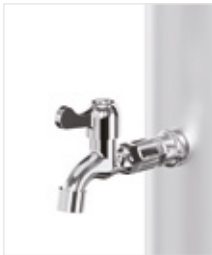
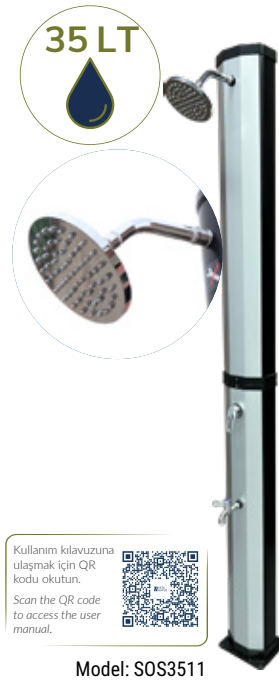

Suni Ahşap Taban Wooden Base



KOD CODE	ÖLÇÜ SIZE	FİYAT PRICE
GAR202310024	64x100 cm	225 €

KOD CODE	TANK KAPASİTESİ TANK CAPACITY	ÖLÇÜ SIZE	TANK CİNSİ TANK MATERIAL	BASINÇ MAX PRESSURE	FİYAT PRICE
GAR2023100082	20 LT	2160xdiax110mm	PVC	4.0 BAR	300 €
GAR2023100081	35 LT	2170x220x180mm	PVC	4.0 BAR	350 €
GAR2023100083 NEW	40 LT	2300x215x160mm	PVC	4.0 BAR	--

Su Perdesi Seti Waterfall Set

NEW

HAZIR SİSTEM COMPLETE SET

Pompa ve hortum ile birlikte sunulan set yapısı sayesinde su perdesi uygulamalarında hızlı ve sorunsuz kurulum sağlar.

Supplied as a complete system with pump and hose, ensuring fast and trouble-free waterfall installation.



Öne Çıkan Özellikler Product Features

- » Pompa, su perdesi ve hortum tek paket halinde sunulur
- » Havuz ve gölet uygulamaları için hazır sistem çözüm
- » Duvar tipi veya gömme su perdesi uygulamalarına uygundur
- » Estetik su akışı ile görsel etkiyi artırır
- » Complete package including pump, waterfall and hose
- » Ready-to-install system for pool and pond applications
- » Suitable for wall-mounted or built-in waterfall installations
- » Enhances visual impact with smooth and aesthetic water flow

Set İçeriği

- CWF-400 Su Perdesi (400 mm ağız genişliği)
- CQB-2000 Dalgıç Pompa
- 2 metre bağlantı hortumu

Set Includes

- CWF-400 Waterfall (400 mm outlet width)
- CQB-2000 Submersible Pump
- 2 m connection hose

SU PERDESİ WATER FALL	
ÜRÜN İTEM	CWF-400 Waterfall
MAX. ÇIKIŞ MAX. OUTPUT	14.000 LPH
HORTUM BAĞLANTISI HOSE CONNECTOR	20 / 25 / 32 / 38 mm
AĞIZ GENİŞLİĞİ WIDTH OF OUTLET	400 mm

DALGIÇ POMPA – CQB-2000 SUBMERSIBLE PUMP	
ÜRÜN İTEM	CQB-2000 Pump
NOMİNAL GÜÇ RATED POWER	35 W
MAX. DEBİ MAX. FLOW	2.300 LPH
MAX. BASMA YÜKSEKLİĞİ MAX. HEAD	2 m
HORTUM BAĞLANTISI HOSE CONNECTOR	20 / 25 mm
GÜÇ KABLOSU UZUNLUĞU POWER CABLE LENGTH	10 m

SET BİLGİSİ SET DETAIL	
SET İÇERİĞİ SET INCLUDED	Su Perdesi + Pompa + 2 m Hortum Water Curtain + Pump + 2 m Hose
ÜRÜN KODU CODE	GAR202310010
ÜRÜN ADI PRODUCT NAME	SU PERDESİ SETİ WATERFALL SET
FİYAT PRICE	277 €

Su Perdesi Waterfall

ESTETİK AKIŞ AESTHETIC FLOW

Gölet ve yüzme havuzlarında sakinleştirici bir atmosfer oluşturur; estetik görünüm ve profesyonel uygulama avantajı sunar.

Creates a calming atmosphere in pools and ponds while enhancing aesthetic appeal and offering professional installation flexibility.

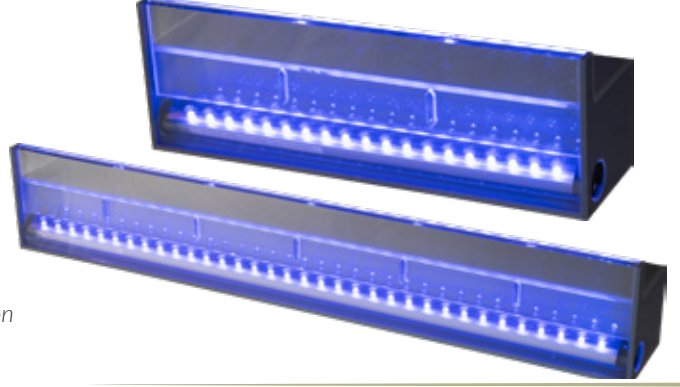

Öne Çıkan Özellikler Product Features

- » Yüzme havuzları veya göletler için özel olarak tasarlanmıştır
- » Sakinleştirici su akışıyla estetik bir atmosfer oluşturur
- » Gölet veya havuz projelerinde görsel etkiyi artırır
- » Su perdesi uygulamalarında profesyoneller için ideal çözümdür

- » Specially designed for swimming pools or ponds
- » Creates a tranquil and visually appealing water flow
- » Enhances the aesthetic impact of pool and pond projects
- » Ideal solution for professionals specializing in waterfall installations

Önemli Noktalar

- Havuz pompasına bağlanabilir veya bağımsız bir sistem olarak kurulabilir
- Klorlu ve tuzlu su havuzlarıyla uyumludur
- Mavi tonlarda LED aydınlatma seçeneği mevcuttur
- Şeffaf çıkış ağız sayesinde her duvar rengiyle uyum sağlar

Highlights

- Can be connected to a pool pump or installed as a standalone system
- Compatible with both chlorine and saltwater pools
- Available with blue-toned built-in LED lighting option
- Transparent lip blends seamlessly with any wall surface



KOD CODE	UZUNLUK PRODUCTION LENGTH	LEDLİ WITH LED	DEBİ FLOW RATE	AĞIZ UZUNLUĞU LIP LENGTH	FİYAT PRICE
GAR202310020	300 mm	+	4000LPH	30 mm	245 €
GAR202310021	600 mm	+	6000LPH	30 mm	320 €
GAR202310022	900 mm	x	10000LPH	30 mm	355 €
GAR202310023	1200 mm	x	12000LPH	30 mm	530 €



Havuz Örtüsü

Pool Cover

GÜVENLİ KORUMA

SAFE PROJECTION

Sağlam yapısı ve UV dayanımıyla havuzunuzu dört mevsim korur, güvenliği ve uzun ömrü bir arada sunar.
With its robust structure and UV resistance, it protects your pool all year round, offering safety and durability together.



Öne Çıkan Özellikler

Product Features

- » Bakım maliyetlerinizi düşürür
- » Sezona girdiğinizde zaman kazandırır
- » UV dayanımı sayesinde uzun ömürlüdür
- » 3 yıl garantilidir
- » Çocukların ve evcil hayvanların güvenliğini sağlar
- » Su ve kir geçirmez
- » Üzerinde yürünebilir
- » Lowers your maintenance costs
- » Saves time when you enter the season
- » Long lasting thanks to its UV resistance
- » 3 years warranty
- » Ensures the safety of your children and pets
- » Water and dirt proof
- » Walkable on it



Dayanıklı Yapı & Uzun Ömür

- Polyester donatılı, PVC 600 gr/m² esaslı dayanıklı kumaştan üretilmiştir
- Her ölçüye özel üretim yapılabilir
- Sağlam yapısı ve emniyet kemerleri sayesinde, üzerinde yürüyen insan ve hayvanlar için güvenlidir
- Paslanmaz çelik ankrajlar korozyona karşı dayanıklıdır
- Havuz suyunu temiz tutmanın yanı sıra dış etkenlere karşı koruma sağlar, havuz ömrünü uzatır
- Üzerinde biriken yağmur suyu, dalgıç pompa yardımıyla tahliye edilerek örtü üzerindeki yükün korunması sağlanır
- Montaj aparatları fiyata dahildir (pompa dahil değildir)
- Alan hesaplamasında, taşma kanalının dış ölçüsünden 10 cm geniş ölçü alınmalıdır

Durable Structure & Long Lifespan

- Made of polyester-reinforced PVC 600 gr/m² durable fabric
- Custom sizes can be produced on request
- Robust structure and safety belts make it safe for people and pets to walk on
- Stainless steel anchors are corrosion-resistant
- Protects not only pool water but also the pool surface from external factors, extending its lifespan
- Rainwater accumulated on the cover is discharged by a submersible pump, keeping the surface protected
- All mounting apparatus are included (pump not included)
- When calculating the area, measure 10 cm wider than the outer edge of the overflow channel

ÜRÜN

PRODUCT

FİYAT

PRICE

Kare - Dikdörtgen Standart Havuz Şekli *Square - Rectangular Standard Pool's Shape*

--

Kare - Dikdörtgen Standart Olmayan Havuz *Square - Rectangular Non Standard Pool*

--

Serbest Biçimli Havuz *Freeform Pool*

--

Merdiven ya da Diğer Özel Şekli Havuzlar İçin Özel Kesim *Special Cut For Pool Ladders or Other Specially Shaped Pools*

--



OLİMPİK EKİPMANLARI OLYMPIC POOL EQUIPMENT

OLİMPİK HAVUZ ÜRÜNLERİ OLYMPIC POOL PRODUCTS

*Her Detayda Mükemmellik
Perfection in Every Detail*

Profesyonel Yarış Standartları.
Professional Racing Standards.

Olimpik havuz ekipmanlarımız, uluslararası standartlarda güvenli ve uzun ömürlü kullanım sağlar.

Our Olympic pool equipment provides safe and long-lasting use at international standards.

Kulvar Seperatörleri Lane Separators

Kulvar Seperatör Yüzdürücü ve Topları Lane Separator Floater and Balls

Üretim Yeri / Manufacturing Location
Türkiye'de Üretilmiştir / Made in Turkey
Marka / Brand
Neta Havuz Ürünü / Neta Pool Product

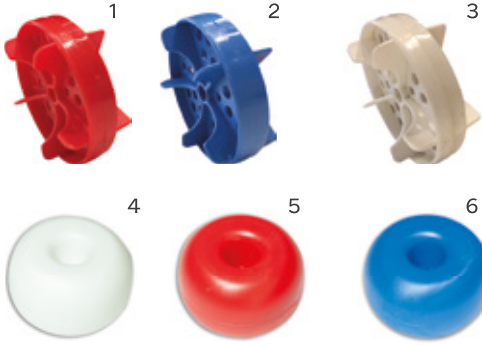

1, 2, 3 Nolu Ürünler
» Polipropilenden üretilmiştir
» Ø100 mm çapındadır

1, 2, 3 Number Products
» Made of polypropylene
» Ø100 mm diameter

4, 5, 6 Nolu Ürünler
» Polipropilenden üretilmiştir
» Ø67 mm çapındadır

4, 5, 6 Number Products
» Made of polypropylene
» Ø67 mm diameter

KOD CODE	MODEL	FİYAT PRICE
13515123002	1- dişi / erkek kırmızı Female / male red	0,50 €
13515123016	2- dişi / erkek mavi Female / male blue	0,50 €
13515123019	3- dişi / erkek beyaz Female / male white	0,50 €
13515123006	4- kulvar topu beyaz Lane ball white	0,50 €
13515123007	5- kulvar topu kırmızı Lane ball red	0,50 €
13515123008	6- kulvar topu mavi Lane ball blue	0,50 €

Kulvar Seperatör Yüzdürücü ve Topları Lane Separator Floater and Balls



Seul



Moskova



Roma

KOD CODE	MODEL	UZUNLUK mt LENGTH mt	FİYAT PRICE
13515123010	Seul	25	476 €
13515123011	Seul	50	961 €
13515123012	Moskova	25	512 €
13515123013	Moskova	50	1.100 €
13515123014	Roma	25	270 €
13515123015	Roma	50	560 €

Atlama Platformları Starting Platforms

Öne Çıkan Özellikler Product Features

- » AISI 304 paslanmaz çelikten üretilmiştir
- » Made from AISI 304 stainless steel
- » Polyester kaymaz yüzey
- » Polyester non-slip surface

Sabit Atlama Platformu Fixed Starting Blocks

KOD CODE	BASAMAK STEP	YÜKSEKLİK cm HEIGHT cm	FİYAT PRICE
13516123001	1	40	630 €
13516132003	2	70	745 €



Sabit 2 Basamaklı Atlama Platformu Fixed 2-Step Starting Platform

KOD CODE	BASAMAK STEP	YÜKSEKLİK cm HEIGHT cm	FİYAT PRICE
13516123002	2	60	720 €



Ayarlanabilir Atlama Platformu Adjustable Starting Blocks

KOD CODE	BASAMAK STEP	YÜKSEKLİK cm HEIGHT cm	FİYAT PRICE
13516132001	1	40	850 €
13516132002	2	70	1.068€

13 cm e kadar öne ve arkaya ayarlanabilme özelliği.
It can be adjusted up to 13 cm front and back.



Seperatör Aksesuarları

Seperator Accessories

Beton Tip Ankraj Concrete Type Anchor

KOD CODE	AĞIRLIK WEIGHT	FİYAT PRICE
13517122008	440 gr	55 €



Fil Savağı Tip Ankraj Finnish Inclined Type Anchor

KOD CODE	AĞIRLIK WEIGHT	FİYAT PRICE
13517122009	440 gr	48 €



Seperatör Ankrağı Bronz Döküm Kromajlı Bronze Casting And Chromated Anchor

KOD CODE	AĞIRLIK WEIGHT	FİYAT PRICE
13517122010	500 gr	83 €



Gerdirme Çubuğu Double Edged Hooked Brass

KOD CODE	AĞIRLIK WEIGHT	FİYAT PRICE
13517122011	215 gr	72 €



Seperatör Gerdirici Bronz Döküm Kromajlı Spring Model Sunborn Bronze Casting And Chromated Ratchet

KOD CODE	AĞIRLIK WEIGHT	FİYAT PRICE
13517122012	720 gr	165 €



Seperatör Aksesuarları

Seperator Accessories

Seperatör Kancası Makaralı Float Line Hook

KOD CODE	AĞIRLIK WEIGHT	FİYAT PRICE
13517122013	40 gr	16 €



Askı Kancası Emniyet Mandalı Hook with Safety Latch

KOD CODE	AĞIRLIK WEIGHT	FİYAT PRICE
13517122014	120 gr	25 €



Su Üstü Bağlama Halkası Overhead Bracket

KOD CODE	AĞIRLIK WEIGHT	FİYAT PRICE
13517122015	250 gr	40 €



Kulvar Sarma Tamburu Float Lines Roller

KOD CODE	UZUNLUK LENGHT	AĞIRLIK WEIGHT	FİYAT PRICE
13517122016	120 cm	215 gr	900 €
13517122017	180 cm	215 gr	1.100 €



Yanlış Çıkış İkaz Direği False Start Indicator

KOD CODE	UZUNLUK LENGHT	FİYAT PRICE
13517122001	12,5 mt	230 €
13517122002	25 mt	285 €

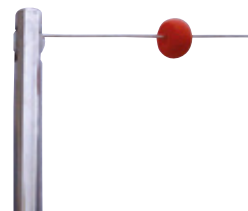

AISI 304 paslanmaz çelik gövde, 2 boru, polyester ip ve şamandıra yapısı, 1,8 m yükseklik, Ø42 mm boru çapı.

Made of AISI 304 stainless steel, consists of 2 pipes, polyester rope and float, 1.8 m height, Ø42 mm pipe diameter.

Geri Dönüş İkaz Direği Backstroke Turn Indicators

KOD CODE	UZUNLUK LENGHT	FİYAT PRICE
13517122003	12,5 mt	270 €
13517122004	25 mt	325 €

AISI 304 paslanmaz çelik gövde
2 boru, ip ve şamandıra seti
1,8 m yükseklik, Ø42 mm çap.
AISI 304 stainless steel body
2 pipes, rope and float set
1.8 m height, Ø42 mm diameter.



Dönüş Paneli ve Desteği Return Panel and Bracket

KOD CODE	UZUNLUK LENGHT	FİYAT PRICE
13517122005	2 mt	435 €
13517122006	2,5 mt	490 €
13517122007 (Panel Desteği Panel Support)	--	390 €

Dönüş Paneli:
AISI 304 paslanmaz çelikten üretilmiştir,
yüzücülere dönüş sırasında destek sağlar.
Panel Desteği:
Dönüş panelini sabitleyen ayak yapısı
Turning Panel:
Made of AISI 304 stainless steel
Provides support for swimmers during turns.
Panel Support:
Foot structure that stabilizes the turning panel.



Can Kurtaran Hakem Koltuğu Life Guard Chair

KOD CODE	UZUNLUK LENGHT	FİYAT PRICE
13021122001	12,5 mt	1.250 €

AISI 304 paslanmaz çelik,
Ø42 mm boru çapı, cam elyaf
takviyeli polyester oturak.
AISI 304 stainless steel, Ø42 mm
pipe diameter, fiberglass-reinforced
polyester seat.





HAZIR HAVUZLAR FIBERGLASS POOLS

FİBERGLASS, YER ÜSTÜ HAVUZLAR, SPALAR FIBERGLASS, ABOVE GROUND POOLS, SPAS

*Hazır Havuzlar, Modern Çözümler
Fiber Pools, Modern Solutions*

Uygulama Süreçlerini Kolaylaştıran Modern Sistemler: Hazır Havuzlar.
Modern Systems that Simplify Implementation Processes: Fiber Pools.

Yer üstü ve fiberglass havuzlar, spa sistemleri ve akrilik cam çözümleriyle projelere esnek uygulama imkânı sağlar.

Provides flexible application options with above-ground and fiberglass pools, spa systems, and acrylic glass solutions.

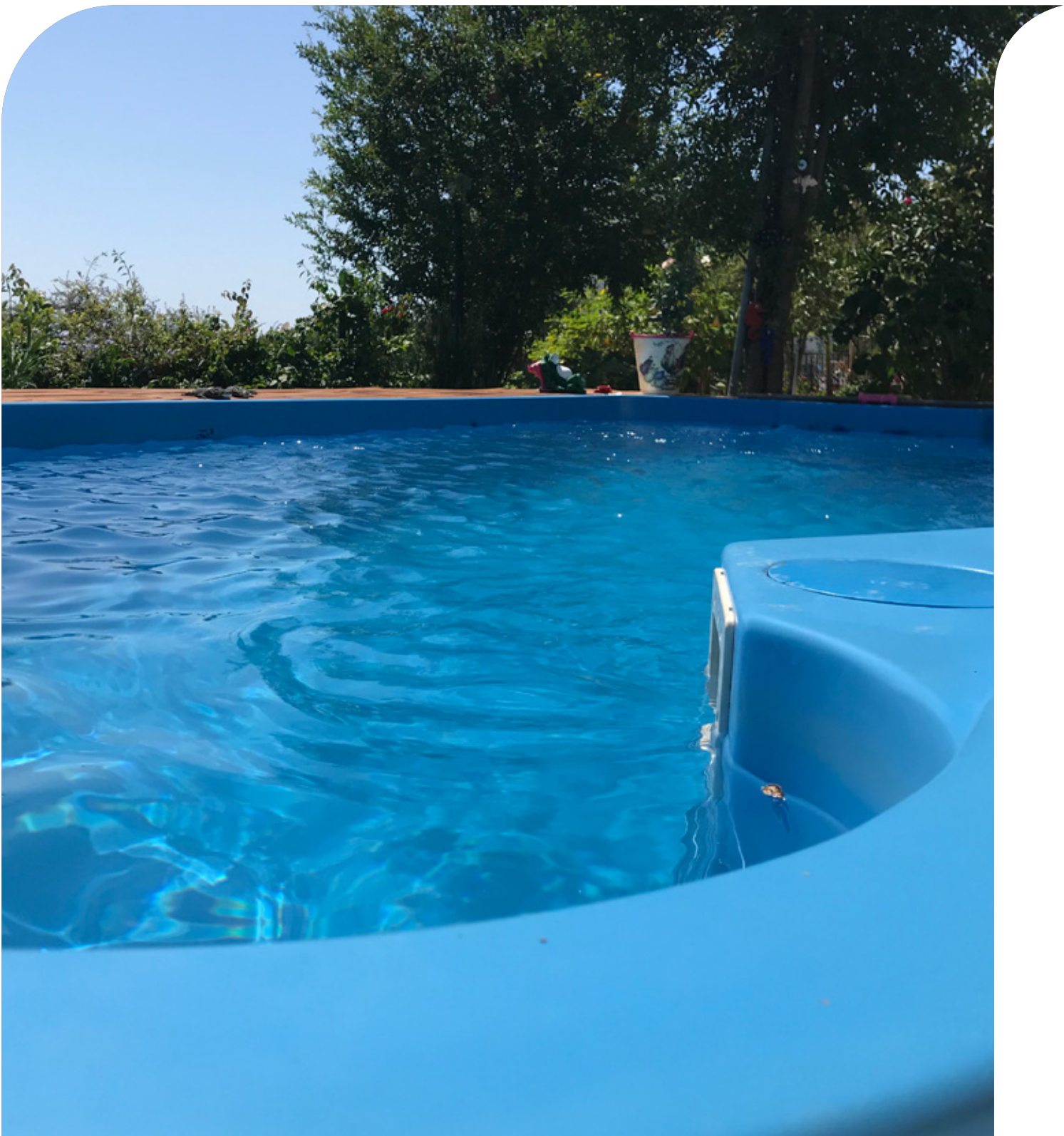

Üretim Yeri / Manufacturing Location
Türkiye'de Üretilmiştir / Made in Turkey

Marka / Brand
Neta Havuz Ürünü / Neta Pool Product

NORA MODEL

Tanıtım filmi



1 NOLU PAKET NUMBER 1 PACKAGE

FİYAT PRICE: 10,800 €

Fiberglass havuz gövdesi,
Kartuşlu skimfilter mekanik sistem içeriği:

- + 1 adet x kartuşlu skimfilter
- + 2 adet x ABS besleme nozulu
- + 1 adet x ABS dip emiş
- + Boru ve bağlantı takımı
- + 1 adet x 0,75 Hp Waterfun Senkron 1 havuz pompası
- + 2 adet x flat ledli ampül lamba armatürü 30w-12v
- + Elektrik kontrol panosu

Fiberglass pool body cartridge skimfilter
mechanical system content:

- + 1 x skimfilter with cartridge
- + 2 x inlet nozzle made of ABS
- + 1 pcs x ABS drain
- + Pipe and connection set
- + 1 pcs x 0,75 Hp Waterfun Senkron 1 pool pump
- + 2 x flat type led light 30W-12V
- + Control panel

2 NOLU PAKET NUMBER 2 PACKAGE

FİYAT PRICE: 11,344 €

Fiberglass havuz gövdesi,
Kum filtreli mekanik sistem içeriği:

- + 1 adet x skimmer
- + 2 adet x ABS besleme nozulu
- + 1 adet x ABS dip emiş
- + Boru ve bağlantı takımı
- + 1 adet x D500 ROTEX kum filtresi (75 kg kum ile birlikte)
- + 1 adet x 0,75 Hp Waterfun Senkron 1 havuz pompası
- + 2 adet x flat ledli ampül lamba armatürü 30w-12v
- + Elektrik kontrol panosu

Fiberglass pool body cartridge skimfilter
sand filter mechanical system content:

- + 1 x skimmer
- + 2 x inlet nozzle made of ABS
- + 1 pcs x ABS drain
- + Pipe and connection set
- + 1 pcs x D500 ROTEX sand filter (with 75 kg sand)
- + 1 pcs x 0,75 Hp Waterfun Senkron 1 pool pump
- + 2 x flat type led light 30W-12V
- + Control panel

2 YEARS
Mechanical Warranty

10 YEARS
Body Warranty

Fast Installation
YES ✓

Made in Turkey
YES ✓

Take Away
YES ✓

2 YIL
Mekanik Garanti

10 YIL
Gövde Garanti

HIZLI KURULUM
EVET ✓

YERLİ ÜRETİM
EVET ✓

AL GÖTÜR
EVET ✓



LARA MODEL

H 1,50



1 NOLU PAKET NUMBER 1 PACKAGE

Fiberglass havuz gövdesi,
Kartuşlu skimfilter mekanik sistem içeriği:

- + 1 adet x kartuşlu skimfilter
- + 2 adet x ABS besleme nozulu
- + 1 adet x ABS dip emiş
- + Boru ve bağlantı takımı
- + 1 adet x 0,75 Hp Waterfun Senkron 1 havuz pompası
- + 2 adet x flat ledli ampül lamba armatürü 30w-12v
- + Elektrik kontrol panosu

Fiberglass pool body cartridge skimfilter
mechanical system content:

- + 1 x skimfilter with cartridge
- + 2 x inlet nozzle made of ABS
- + 1 pcs x ABS drain
- + Pipe and connection set
- + 1 pcs x 0,75 Hp Waterfun Senkron 1 pool pump
- + 2 x flat type led light 30W-12V
- + Control panel

2 NOLU PAKET NUMBER 2 PACKAGE

Fiberglass havuz gövdesi,
Kum filtreli mekanik sistem içeriği:

- + 1 adet x skimmer
- + 2 adet x ABS besleme nozulu
- + 1 adet x ABS dip emiş
- + Boru ve bağlantı takımı
- + 1 adet x D500 ROTEX kum filtresi (75 kg kum ile birlikte)
- + 1 adet x 0,75 Hp Waterfun Senkron 1 havuz pompası
- + 2 adet x flat ledli ampül lamba armatürü 30w-12v
- + Elektrik kontrol panosu

Fiberglass pool body cartridge skimfilter
sand filter mechanical system content:

- + 1 x skimmer
- + 2 x inlet nozzle made of ABS
- + 1 pcs x ABS drain
- + Pipe and connection set
- + 1 pcs x D500 ROTEX sand filter (with 75 kg sand)
- + 1 pcs x 0,75 Hp Waterfun Senkron 1 pool pump
- + 2 x flat type led light 30W-12V
- + Control panel

3,20 x 6,20
mt

3,20 x 7,20
mt

4,00 x 10,00
mt

PAKET 1	HAVUZ ÖLÇÜSÜ POOL SIZE	FİYAT PRICE
	3,20 x 6,20 mt	12.840 €
	3,20 x 7,20 mt	14.280 €



PAKET 2	HAVUZ ÖLÇÜSÜ POOL SIZE	FİYAT PRICE
	3,20 x 6,20 mt	13.240 €
	3,20 x 7,20 mt	14.680 €



An aerial photograph of a large, rectangular, blue inflatable pool set up on a stone patio. The pool is filled with clear blue water, and a person is swimming in the center. In the top left corner, there is a lounge chair with a red cushion and a small table with a glass. The pool is surrounded by a dark stone patio and a wooden fence. The text 'EVA MODEL' is overlaid in the center of the pool in a large, white, bold, sans-serif font.

EVA MODEL

Diğer Modeller The Other Models

	MODEL MODEL	BOYUT SIZE	MERDİVEN LADDER	ŞEZLONG ALANI SUNBAD AREA	MASAJ SETİ MASSAGE SET	SKIM FİLTRELİ FİYAT PRICE FOR SKIM FILTER	KUM FİLTRELİ FİYAT PRICE FOR SAND FILTER
TINA		3 x 6	✓	—	—	hemenhavuz.com ✨	hemenhavuz.com ✨
		3 x 7	✓	—	—	hemenhavuz.com ✨	hemenhavuz.com ✨
		3 x 8	✓	—	—	hemenhavuz.com ✨	hemenhavuz.com ✨
EVA		4 x 8	✓	—	✓	hemenhavuz.com ✨	hemenhavuz.com ✨
		4 x 10	✓	—	✓	hemenhavuz.com ✨	hemenhavuz.com ✨
GLORIA		Çap 2,20 h 0,90	✓	—	✓	hemenhavuz.com ✨	—

OPSIYONEL ÜRÜNLER OPSIONAL PRODUCTS

Mekanik sistem odası 1

Paket 1'e uygun CTP makina dairesi
70x60x50 cm ebatlı

Mechanical system room 1

FRP machine room suitable for package 1, 70x60x50 cm size

FİYAT PRICE: 200 €

Mekanik sistem odası 2

Paket 2'ye uygun CTP makina dairesi
100x100x90 cm ebatlı

Mechanical system room 2

FRP machine room suitable for package 2 100x100x90 cm size

FİYAT PRICE: 599 €

Havuz temizlik seti

1 takım, (süpürge sapı ve hortumu, kepçe, fırça, cl-ph test kiti)

Pool Cleaning Kit

1 set (broom, handle and hose, bucket, brush, cl-pH test kit)

FİYAT PRICE: 100 €

Dezenfeksiyon cihazları

Blue lagon uv-c ultraviyole ile dezenfeksiyon cihazı 40 w tuz klor jeneratörü ssc mini tuzdan klor üretir

Disinfection Equipments

Blue Lagon with UV-C ultraviolet disinfection device 40w salt chlorine generator SSC mini produces chlorine from salt

Havuz suyu ısıtma cihazı

Electro Napo SPA 6 kW eşanjör + PVC boru vana bağlantısı

Pool Heater

Electric Nano SPA Electro brand 6 kW heat exchanger

FİYAT PRICE: 530 €

4 nozullu hydro masaj seti

1.5 hp Senkron 1 masaj pompa ve nozullar sistem bağlantı takımı kumanda sistemi ile takım

Hydro massage set with 4 nozzles

1.5 hp Senkron 1 massage pump and nozzles system connection kit with control system

FİYAT PRICE: 680 €

18 nozullu hydro masaj seti (Nora model için geçerlidir)

1.5 hp Senkron 1 masaj pompa ve nozullar sistem bağlantı takımı kumanda sistemi ile takım

Hydro massage set with 18 nozzles (for Nora model)

1.5 hp Senkron 1 massage pump and nozzles system connection kit with control system

FİYAT PRICE: 1.100 €

Karşı akıntı sistemi kit-up jet set

Pompa ve kumanda seti ile takım + 3,5 hp pompa ile

Jet stream equipment kit-up jet set with pump and control set + with pump 3,5 hp

FİYAT PRICE: 1.730 €

Fiyatlara KDV ilave edilecektir.
Fiyatlara nakliye ve vinç hizmetleri dahil değildir.
Fiyatlar fabrika teslimidir.
Türkiye sahilinde nakliye fiyatları 500-650 euro mertebesindedir.
Teslim adresinize göre nakliye fiyatı sorunuz.
Fiyatlara montaj ve işçilik dahil değildir.

VAT will be added to prices.
Prices do not include shipping or crane services.
Prices are ex-factory.
Shipping costs within Turkey are around €500-650.
Please inquire about shipping prices based on your delivery address.
Prices do not include assembly or labor.



Detaylı bilgi için QR kodu okutun.

Scan the QR code to for detail.



Bestway Havuzlar





MODEL MODEL	BOYUT SIZE	PAKETE DAHİL OLANLAR INCLUDING IN	DETAYLI BİLGİ MORE DETAIL	KOD CODE
----------------	---------------	--------------------------------------	------------------------------	-------------

FAST SET		2,16 m x 71 cm	Pompa, kartuş filtre, ısıtıcı, blower, örtü, dispenser Pump, cartridge filter, ladder, blower, dispenser, pool cover, heater		PSFAC57450
-------------	---	----------------	---	---	------------

						
Montaj kolaylığı Easy to assemble	Alet ihtiyacı yok No tools required	Kendinden destekli işime üst halka Self-supporting inflatable top ring	DuraPlus Malzeme DuraPlus Material	Gider vanası Drain Valve	Kolay saklanır Easy to store	Kolay taşınır Easy to transport

STEEL PRO		3,00 m x 2,01 m x 66 cm	Pompa, kartuş filtre Pump, cartridge filter		PSFAC56411
--------------	--	-------------------------	--	--	------------







				
Montaj kolaylığı Easy to assemble	Alet ihtiyacı yok No tools required	Korozyon direnci çelik çerçeve Corrosion-resistant steel frame	DuraPlus Malzeme DuraPlus Material	Gider vanası Drain Valve

POWER STEEL		4,12m x 2,01m x 1,22m	Pompa, kartuş filtre, merdiven, dispenser Pump, cartridge filter, ladder, dispenser		PSFAC56456
		4,88m x 2,44m x 1,22m	Pompa, kartuş filtre, merdiven, dispenser, örtü Pump, cartridge filter, ladder, dispenser, pool cover		PSFAC56670
		6,40m x 2,74m x 1,32m	Pompa, kartuş filtre, merdiven, dispenser, örtü Pump, cartridge filter, ladder, dispenser, pool cover		PSFAC5612B
		7,32m x 3,66m x 1,32m	Pompa, kartuş filtre, merdiven, dispenser, örtü Pump, cartridge filter, ladder, dispenser, pool cover		PSFAC56475
		9,56m x 4,88m x 1,32m	Pompa, kartuş filtre, merdiven, dispenser, örtü Pump, cartridge filter, ladder, dispenser, pool cover		PSFAC56623
		5,49m x 2,74m x 1,22m	Pompa, kartuş filtre, merdiven, dispenser, örtü Pump, cartridge filter, ladder, dispenser, pool cover		PSFAC56716

							
Montaj kolaylığı Easy to assemble	Alet ihtiyacı yok No tools required	Korozyon direnci çelik çerçeve Corrosion-resistant steel frame	DuraPlus Malzeme DuraPlus Material	Gider vanası Drain Valve	3 katlı güçlendirme bandı 3 ply PVC wall support band	Prizmatik taş baskı Prismatic stone print	Chemconnect klorlama sistemi Chemconnect

Bestway Pools

MODEL MODEL	BOYUT SIZE	PAKETE DAHİL OLANLAR INCLUDING IN	DETAYLI BİLGİ MORE DETAIL	KOD CODE
----------------	---------------	--------------------------------------	------------------------------	-------------

HYDRIMUM		3,00m x 1,20m	Pompa, kum filtre, merdiven, dispenser, örtü, yer örtüsü, skimmer Pump, sand filter, ladder, dispenser, pool cover, ground cloth, skimmer		PSFAC56566
		3,60m x 1,20m	Pompa, kum filtre, merdiven, dispenser, örtü, yer örtüsü, skimmer Pump, sand filter, ladder, dispenser, pool cover, ground cloth, skimmer		PSFAC56574
		5,00m x 3,60m x 1,20m	Pompa, kum filtre, merdiven, dispenser, örtü, yer örtüsü, skimmer Pump, sand filter, ladder, dispenser, pool cover, ground cloth, skimmer		PSFAC56586
		6,10m x 3,60m x 1,20m	Pompa, kum filtre, merdiven, dispenser, örtü, yer örtüsü, skimmer Pump, sand filter, ladder, dispenser, pool cover, ground cloth, skimmer		PSFAC56369
		7,30m x 3,60m x 1,30m	Pompa, kum filtre, merdiven, dispenser, örtü, yer örtüsü, skimmer Pump, sand filter, ladder, dispenser, pool cover, ground cloth, skimmer		PSFAC561CW



Direçli galvanize çelik yapı
Reinforced galvanized
steel sidewalls



Premium pvc havuz kaplaması
Premium pvc pool liner



Entegre yüzey skimmeri
Integrated surface skimmer







Özel kaplama çelik havuz kenarı
Special reinforced steel pool ledge



Paletli yükleme
Shipped on pallet



Yıl boyu kullanım
Year-round use

LAY-Z SPA		2,16 m x 71 cm	Pompa, kartuş filtre, ısıtıcı, blower, örtü, dispenser Pump, cartridge, ladder, blower, dispenser, pool cover, heater		PSFAC60023
		1,80 m x 66 cm	Pompa, kartuş filtre, ısıtıcı, blower, örtü, dispenser Pump, cartridge, ladder, blower, dispenser, pool cover, heater		PSFAC60025



Swimfinity Jet Stream

SONSUZ YÜZÜŞ ENDLESS SWIMMING

Yer üstü ve gömme havuzlarda kullanılabilen Swimfinity™, ayarlanabilir su akışıyla profesyonel yüzme antrenmanlarına olanak sağlar.

Swimfinity™, compatible with both above-ground and in-ground pools, provides adjustable water flow for professional swim training.



Öne Çıkan Özellikler Product Features

Dirençli Yüzme Deneyimi

» Yüzcülerin yerinde yüzmesini sağlayan ayarlanabilir akıntı sistemiyle antrenmanlarda verimlilik sağlar.

Ayarlanabilir Su Akışı

» Su hızını ve gücünü kullanıcı tercihlerine göre ayarlayabilirsiniz.

Egzersiz performansını optimize eder.

Kişiselleştirilebilir Antrenman

» Su akışının derinliği ve açısı ayarlanabilir. Böylece farklı seviyelerde yüzme egzersizleri için kişisel program oluşturabilirsiniz.

Geniş Uyumluluk

» Hem yer üstü hem de gömme havuzlarla uyumlu tasarımı sayesinde kurulumu kolaydır.

Uzaktan Kumanda

» Su akışını başlatma, durdurma ve hız ayarını su geçirmez uzaktan kumanda ile kontrol edebilirsiniz.

Gece Kullanımı

» LED aydınlatma sayesinde gece de güvenli ve keyifli egzersiz yapabilirsiniz.

Resistant Swim Experience

» Enables swimmers to train in place against an adjustable water current, improving workout efficiency.

Adjustable Water Flow

» The water speed and intensity can be customized to match the user's training needs and performance level.

Personalized Training

» The depth and angle of the current can be adjusted, allowing complete personalization of swimming sessions.

Wide Compatibility

» Compatible with both above-ground and in-ground pools, offering flexible installation options.

Remote Control

» Features a waterproof remote for adjusting speed and pausing the water flow during training.

Night Use

» Equipped with an LED light for nighttime exercise, ensuring safe and enjoyable workouts at any hour.

Montajını izlemek için QR kodu okutun.

Scan the QR code to watch the installation.

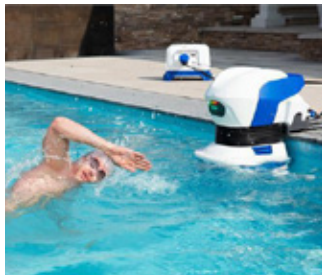

Nasıl çalışır izlemek için QR kodu okutun.

Scan the QR code to watch how to work.



KOD
CODE

PSFAC58517

ZORLUK SEVİYESİ
INTENSITY LEVELS

8

FİYAT
PRICE

1.710 \$

Akrilik Cam Acrylic Glass Panel

NEW

KRİSTAL DAYANIKLILIK CRYSTAL STRENGTH

Yüksek ışık geçirgenliği, UV dayanımı ve darbe direnciyle akrilik cam paneller, havuz projelerinde estetik ve güvenliği bir arada sunar.

With high light transmittance, UV resistance, and impact strength, acrylic glass panels combine aesthetics and safety in pool projects.



Öne Çıkan Özellikler Product Features

Yüksek Şeffaflık

» Cam netliğinde görünüm, %92 ışık geçirgenliğiyle kusursuz su altı görünümü sağlar.

Üstün Dayanıklılık

» Camdan 16 kat daha darbe dayanımlı, uzun ömürlü ve güvenlidir.

Hafif ve Şekillendirilebilir

» Camdan %50 daha hafif olup, düz veya kavisli formda üretilebilir.

UV Koruması

» Güneş ışığına ve sararmaya karşı 10 yıl garantili UV dayanımı sunar.

High Transparency

» Provides crystal-clear visibility with 92% light transmission for a flawless underwater view.

Superior Durability

» Sixteen times stronger than glass, ensuring long-lasting performance and safety.

Lightweight & Formable

» 50% lighter than glass, thermoformable for custom shapes.

UV Protection

» UV resistant for 10 years, prevents yellowing.



Teknik Özellikler Technical Specifications

- **Işık geçirgenliği:** %92
- **Darbe dayanımı:** Normal camdan 16 kat daha güçlü
- **Ağırlık:** Camın yarısı kadar hafif
- **UV ve kimyasal direnci:** yüksek
- **Dayanıklılık:** Dış ortam koşullarına karşı uzun ömürlü
- **Asit, alkali ve hava koşullarına dayanıklı**
- **Şekillendirilebilirlik:** Şekillendirilebilir (düz, eğimli veya silindirik üretim imkânı)
- **Güvenlik:** Zehirsiz, insan temasına uygun malzeme
- **Light Transmittance:** 92%
- **Impact Resistance:** 16 times stronger than ordinary glass
- **Weight:** Half the weight of glass
- **UV and Chemical Resistance:** High
- **Durability:** Long service life under outdoor conditions
- **Weather Resistance:** Resistant to acid, alkali, and environmental effects
- **Forming Capability:** Can be produced flat, curved, or cylindrical
- **Safety:** Non-toxic, suitable for direct human contact

Tüm teknik bilgiler için QR kodu okutun.

Scan the QR code to full technical documentation.



KALINLIK THICKNESS	PANEL ÖLÇÜLERİ MAX SIZE	UYGULAMA ALANI APPLICATION
20-100 mm	2000 x 6000 mm	Küçük ve orta ölçekli havuzlar <i>Small and medium-sized pools</i>
100-300 mm	3000 x 9000 mm	Büyük ölçekli veya özel tasarımlar <i>Large-scale or custom-designed pools</i>
Özel üretim <i>Custom production</i>	Talebe göre <i>According to project requirements</i>	Eğimli veya silindirik paneller <i>Curved or cylindrical panels</i>

Su Yalıtım Membranı Avantajları Waterproofing Membrane Benefits

- Uygulaması kolaydır, kısa sürede tamamlanabilir.
- Easy to apply, can be completed in a short time.
- Her türlü yüzeye uygulanabilir.
- Can be applied to all kinds of surfaces.
- Basınca karşı dayanıklıdır.
- Resistant to pressure.
- %100 su yalıtımı sağlar.
- Provides 100% waterproofing.
- Yapıştırıcının zemin ve Almera Tex ile kurlenme süresi beklenilmeden üzeri mozaik veya benzeri ürünler ile kaplanabilir.
- Can be coated with mosaic or similar products , without waiting for the adhesive curing time between the floor and Almera Tex.
- Basınç ve ek gerilim kuvvetlerine karşı dayanıklıdır.
- Resistant to pressure and additional tension forces.
- Mekanik etkilere karşı dayanımı yüksektir.
- High resistance against mechanical effects.
- Yırtılma ihtimali çok düşüktür.
- Low tearing probability.



KULLANIM ALANLARI USAGE OF AREAS

- Havuz Pool
- Teras Over Terrace
- Balkon Balcony
- Otopark Car parks
- Banyo Bath
- Sauna Sauna
- SPA SPA
- Su deposu Water tanks
- Prefabrik yapılar Prefabric constructions
- Kat araları Mezzanine Floors
- Çatı betonları Roof concretes
- Yerden ısıtma sistemleri Underfloor heating systems
- Karo kaplama malzemelerinin zemini
Tile pavement materials flooring
- Açı paneller Gypsum panels
- Beton paneller Concrete panels

3 katlı sandviç sistemi ile üretilmiştir.
It is produced with 3-layer sandwich system.

İki dış yüzeyi polipropilen, içi lamine edilmiş polietilenden üretilmiştir.
It is made of two outer surface from polypropylene and inner surface from laminated polyethylene.

Dış yüzeylerin lifli yapısı uygulandığı yüzeylere güçlü bir şekilde yapışmasını sağlar.

The fibrous structure of the outer surfaces ensures a strong adhesion to the applied surfaces.

Kullanım videosunu
izlemek için QR kodu
okutun.



Scan the QR code to
watch the usage video.

Almera

tex 230

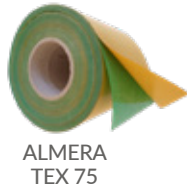
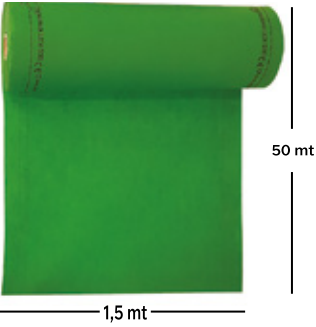

ALMERA
TEX 75



BORU MANŞETİ
PIPE CONDUIT



DIŞ KÖŞE MANŞETİ
OUTER CORNER CONDUIT



ALMERA
CORD 125



İÇ KÖŞE MANŞETİ
INNER CORNER CONDUIT

KOD CODE	ÜRÜN ADI PRODUCT NAME	BİRİM UNIT	ÖLÇÜLER DIMENSIONS	FİYAT PRICE
69015341001	Almera tex 230	m ²	150cmx50m	10,60 €
69015341006	Almera tex dış köşe manşeti <i>Outer corner conduit</i>	ADET PCS	62,5mmx125m	4,00 €
69015341005	Almera tex iç köşe manşeti <i>Inner corner conduit</i>	ADET PCS	62,5mmx125m	4,00 €
69015341004	Almera tape 75 yapışkanlı ek yeri kapama bandı <i>Sticker tape</i>	MTUL	75mmx25m	5,30 €
69015341002	Almera cord 125 tekstil pah bandı <i>Join membrane</i>	MTUL	125mmx50m	5,70 €
69015341010	İzolasyon yapıştırıcı Almeralastic <i>Insulation Adhesive Almeralastic</i>	ADET PCS	15 Kg	7,70 €
69015341007	Almera tex havuz boru geçiş <i>Pool pipe conduit dn50</i>	ADET PCS	DN50x127mm	5,90 €
69015341008	Almera fix tekstil tesisat boru geçiş manşeti <i>Pipe conduit 1 ½"-1"</i>	ADET PCS	½" -1"	4,70 €

PVC VANA BORU & EK PARÇALAR

PVC VALVE PIPES & FITTINGS



PVC VANA ÇÖZÜMLERİ

PVC VALVE SOLUTIONS

Akıřta PVC Gücü
PVC Power in Flow

PVC Boru ile Kesintisiz Sirkülasyon.
Uninterrupted Circulation with PVC Pipe..

Her ölçekte projeye uygun, sızdırmaz ve dayanıklı PVC boru sistemleri.
Leak-proof and durable PVC pipe systems suitable for projects of any scale.

U-PVC Yapıştırma Muflu Küresel Su Vanası U-PVC Solvent Cement True Union Ball Valve For Water



KOD CODE	ÇAP Ø mm DIA Ø mm	İNÇ INCH	AĞIRLIK WEIGHT	KOLİ-ADET BOX-PCS	FİYAT PRICE
16515332001	20	½"	0,14 kg	55	5,20 €
16515332002	25	¾"	0,18 kg	75	5,50 €
16515332003	32	1"	0,25 kg	60	6,50 €
16515332004	40	¼"	0,43 kg	30	7,00 €
16515332005	50	½"	0,65 kg	20	8,20 €
16515332006	63	2"	1,13 kg	12	10,80 €
16515332007	75	1 ½"	1,47 kg	5	28,00 €
16515332008	90	3"	3,58 kg	4	37,00 €
16515332010	110	4"	5,43 kg	2	55,00 €

UV dayanımlı polietilen gövde.
UV-resistant polyethylene body.

U-PVC Yapıştırma Muflu Yaylı Çekvalf U-PVC Solvent Cement Spring Check Valve



KOD CODE	ÇAP Ø mm DIA Ø mm	BASINÇ PN	AĞIRLIK WEIGHT	KOLİ-ADET BOX-PCS	FİYAT PRICE
16517002022	25	16	0,14 kg	75	5,75 €
16517002016	32	16	0,20 kg	60	7,15 €
16517002015	40	16	0,43 kg	32	7,85 €
16517002001	50	16	0,65 kg	20	8,85 €
16517002002	63	16	1,13 kg	13	11,75 €
16517002003	75	16	1,47 kg	9	27,50 €
16517002004	90	16	3,58 kg	4	30,50 €
16517002021	110	16"	5,43 kg	2	53,50 €

UV dayanımlı polietilen gövde.
UV-resistant polyethylene body.

U-PVC ıplak alparalı ekvalf U-PVC Wafer Check Valve



KOD CODE	AP � mm DIA � mm	BASIN PN	AĐIRLIK WEIGHT	KOLİ-ADET BOX-PCS	FİYAT PRICE
16517002027	63	10	0,19 kg	5	20,75 �
16517002026	75	10	0,26 kg	5	25,75 �
16517002024	90	10	0,34 kg	5	28,75 �
16517002025	110	10	0,48 kg	5	33,85 �
PVCCHE-VALF-125-IP	125	10	0,55 kg	5	38,80 �
PVCHEK-VAL-141	140	10	0,64 kg	5	44,40 �
PVCHE-VAL-160	160	10	0,95 kg	5	50,00 �
PVCCHE-VALF-200-IP	200	10	1,32 kg	5	62,00 �
PVCCHE-VALF-225	225	10	1,57 kg	5	71,00 �

UV dayanımlı polietilen g vde.
UV-resistant polyethylene body.

U-PVC alparalı ekvalf U-PVC Wafer Check Valve



KOD CODE	AP � mm DIA � mm	BASIN PN	AĐIRLIK WEIGHT	KOLİ-ADET BOX-PCS	FİYAT PRICE
16517002020	63	10	1,83 kg	1	38,00 �
16517002023	75	10	2,31 kg	1	42,00 �
16517002005	90	10	3,75 kg	1	48,00 �
16517002006	110	10	4,35 kg	1	58,00 �
16517002007	125	10	5,35 kg	1	63,00 �
16517002008	140	10	5,87 kg	1	73,00 �
PVC CHECK VALF-160	160	10	7,03 kg	1	83,00 �
16517002010	200	10	10,0 kg	1	124,00 �
16517002011	225	10	10,05 kg	1	144,00 �
16517002012	250	10	16,2 kg	1	304,00 �
16517002019	280	10	15,5 kg	1	378,00 �
16517002013	315	10	19,8 kg	1	531,00 �
16517002014	400	10	--	1	1.800 �

UV dayanımlı polietilen g vde.
UV-resistant polyethylene body.

UH-PVC Yapıştırma Muflu Serbest Flanş UH-PVC Solvent Cement Flange



KOD CODE	ÇAP Ø mm DIA Ø mm	BASINÇ PN	AĞIRLIK WEIGHT	KOLİ-ADET BOX-PCS	FİYAT PRICE
165002091	32	16	0,18 kg	80	1,30 €
165002092	40	16	0,29 kg	50	1,58 €
165002093	50	16	0,23 kg	48	1,58 €
165002094	63	16	0,30 kg	25	1,73 €
165002095	75	16	0,40 kg	40	2,26 €
165002096	90	16	0,46 kg	35	2,52 €
165002097	110	16	0,53 kg	22	2,68 €
165002098	125	16	0,78 kg	18	3,73 €
165002099	140	16	0,74 kg	18	3,69 €
165002100	160	16	0,81 kg	14	4,95 €
165002101	200	16	1,67 kg	8	9,55 €
165002102	225	16	1,23 kg	8	9,55 €
PVCFLANŞ-250	250	16	2,19 kg	7	46,20 €
PVCFLANŞ-280	280	16	1,58 kg	7	36,96 €
PVCFLANŞ-315	315	16	2,96 kg	7	46,89 €

UV dayanımlı polietilen gövde.

UV-resistant polyethylene body.

UH-PVC Yapıştırma Flanşlı Manşon UH-PVC Solvent Cement Flange Socket



KOD CODE	ÇAP Ø mm DIA Ø mm	BASINÇ PN	KOLİ-ADET BOX-PCS	FİYAT PRICE
1651002147	32	16	50	1,90 €
1651002148	40	16	50	2,29 €
1651002149	50	16	50	2,29 €
1651002150	63	16	30	2,46 €
1651002151	75	16	20	3,15 €
1651002152	90	16	15	3,70 €
1651002153	110	16	10	4,61 €
1651002154	125	16	10	6,42 €
1651002155	140	16	10	7,27 €
1651002156	160	16	6	10,23 €

UV dayanımlı polietilen gövde.

UV-resistant polyethylene body.

UH-PVC T Çekvalf UH-PVC T Check Valve



KOD CODE	ÇAP Ø mm DIA Ø mm	BASINÇ PN	AĞIRLIK WEIGHT	KOLİ-ADET BOX-PCS	FİYAT PRICE
16517002017	50	10	0,30 kg	40	5,50 €
16517002018	63	10	0,46 kg	22	7,00 €
16517002028	75	10	0,53 kg	9	17,00€
16517002029	90	10	1,10 kg	8	25,93 €

UV dayanımlı polietilen gövde.

UV-resistant polyethylene body.

U-PVC Kelebek Vana (Çıplak) U-PVC Butterfly Valve (Without Flange)



KOD CODE	ÇAP Ø mm DIA Ø mm	BASINÇ PN	AĞIRLIK WEIGHT	KOLİ-ADET BOX-PCS	FİYAT PRICE
16516123001	63	10	1,18 kg	1	41,00 €
V-KELE-75-ÇIP	75	10	1,26 kg	1	45,00 €
V-KELE-90-ÇIP	90	10	1,42 kg	1	48,00 €
V-KELE-110-ÇIP	110	10	2,23 kg	1	55,00 €
V-KELE-125-ÇIP	125	10	2,77 kg	1	62,00 €
V-KELE-140-ÇIP	140	10	2,77 kg	1	62,00 €
V-KELE-160-CIP	160	10	3,22 kg	1	79,00 €
16516123008	200	10	5,12 kg	1	132,00 €
16516123009	225	10	5,12 kg	1	132,00 €
16516123010	250	10	9,14 kg	1	350,00 €
16516123011	280	10	9,14 kg	1	350,00 €
V-KELE-315-ÇIP	315	10	24,03 kg	1	900,00 €
16516123013	355	6	--	1	3.268,87 €
16516123014	400	6	--	--	3.268,87 €

UV dayanımlı polietilen gövde.

UV-resistant polyethylene body.

U-PVC Flanşlı Kelebek Vana (Takım) U-PVC Butterfly Valve With Flange Adaptor



KOD CODE	ÇAP Ø mm DIA Ø mm	BASINÇ PN	AĞIRLIK WEIGHT	KOLİ-ADET BOX-PCS	FİYAT PRICE
16516002005	63	10	3,00 kg	1	60,00 €
16516002004	75	10	5,00 kg	1	65,00 €
16516002003	90	10	6,60 kg	1	72,00 €
V-KELE-110-KOMPLE	110	10	6,60 kg	1	81,00 €
V-KELE-125-KOMPLE	125	10	9,50 kg	1	95,00 €
16516002002	140	10	9,90 kg	1	95,00 €
V-KELE-160-KOMPLE	160	10	11,40 kg	1	139,00 €
V-KELE-200-	200	10	17,10 kg	1	195,00 €
V-KELE-225	225	10	36,70 kg	1	199,00 €
V-KELE-250-CİVATALI	250	10	36,70 kg	1	505,00 €
V-KELE-280	280	10	39,20 kg	1	520,00 €
16516123030	315	10	44,50 kg	1	1.200 €
16516123031	355	6	--	--	4.485 €
V-KELE-400-CİVATALI	400	6	--	-	4.485 €

UV dayanımlı polietilen gövde.
UV-resistant polyethylene body.

UH-PVC Rakor UH-PVC Union



KOD CODE	ÇAP Ø mm DIA Ø mm	BASINÇ PN	AĞIRLIK WEIGHT	KOLİ-ADET BOX-PCS	FİYAT PRICE
PVCRAK-YAP-20	20	16	0,05 kg	125	1,35 €
PVCRAK-YAP-25	25	16	0,07 kg	100	1,90 €
PVCRAK-YAP-32	32	16	0,09 kg	50	2,60 €
PVCRAK-YAP-40	40	16	0,16 kg	30	2,85 €
PVCRAK-YAP-50	50	16	0,189 kg	45	3,90 €
PVCRAK-YAP-63	63	16	0,35 kg	30	4,60 €
PVCRAK-YAP-75	75	16	0,585 kg	18	12,00 €
PVCRAK-YAP-90	90	16	0,98 kg	12	16,50 €
PVCRAK-YAP-110	110	16	1,47 kg	7	21,50 €

UV dayanımlı polietilen gövde.
UV-resistant polyethylene body.

UH-PVC Tek Taraf İten Diřli Rakor UH-PVC One Side Female Threaded Union



KOD CODE	AP Ø mm DIA Ø mm	RP INCH	BASIN PN	AĐIRLIK WEIGHT	KOLİ-ADET BOX-PCS	FİYAT PRICE
PVCRAK-DİŐYAP-20	20	½"	16	0,05 kg	125	2,00 €
PVCRAK-DİŐYAP-25	25	¾"	16	0,07 kg	100	2,60 €
PVCRAK-DİŐYAP-26	32	1"	16	0,085 kg	50	3,50 €
PVCRAK-DİŐYAP-40	40	1 ¼"	16	0,155 kg	30	3,80 €
PVCRAK-DİŐYAP-50	50	1 ½"	16	0,25 kg	45	5,00 €
PVCRAK-DİŐYAP-63	63	2"	16	0,48 kg	30	6,00 €
PVCRAK-DİŐYAP-75	75	2 ½"	16	0,6 kg	18	13,50 €
PVCRAK-DİŐYAP-90	90	3"	16	1,005 kg	12	18,00 €
PVCRAK-DİŐYAP-110	110	4"	16	1,485 kg	7	23,00 €

UV dayanımlı polietilen gvde.

UV-resistant polyethylene body.

UH-PVC ift Taraf İten Diřli Rakor UH-PVC Both Sides Female Threaded Union





KOD CODE	AP Ø mm DIA Ø mm	RP INCH	BASIN PN	AĐIRLIK WEIGHT	KOLİ-ADET BOX-PCS	FİYAT PRICE
PVCRAK-2DİŐ-20	20	½"	16	0,05 kg	125	2,50 €
PVCRAK-2DİŐ-25	25	¾"	16	0,07 kg	100	3,10 €
PVCRAK-2DİŐ-32	32	1"	16	0,09 kg	50	4,10 €
PVCRAK-2DİŐ-40	40	1 ¼"	16	0,15 kg	30	4,35 €
PVCRAK-2DİŐ-50	50	1 ½"	16	0,25 kg	45	5,90 €
PVCRAK-2DİŐ-63	63	2"	16	0,50 kg	30	6,85 €

UV dayanımlı polietilen gvde.

UV-resistant polyethylene body.

UH-PVC Pompa Rakoru Dıştan Dişli UH-PVC Male Threaded Union



KOD CODE	ÇAP Ø mm DIA Ø mm	RP INCH	BASINÇ PN	AĞIRLIK WEIGHT	KOLİ-ADET BOX-PCS	FİYAT PRICE
198123208	50	½"	16	0,23 kg	50	4,10 €
198002005	63	2"	16	0,39 kg	25	4,95 €
198123181** 	50	1 ½"	16	0,23 kg	-	7,00 €
198123182** 	63	2"	16	0,39 kg	-	10,00 €

UV dayanımlı polietilen gövde.

UV-resistant polyethylene body.

UH-PVC Rakor Dış Diş Pirinç Çıkışı UH-PVC Union Outlet Male Threaded Brass



KOD CODE	ÇAP Ø mm DIA Ø mm	RP INCH	BASINÇ PN	AĞIRLIK WEIGHT	KOLİ-ADET BOX-PCS	FİYAT PRICE
PVCRAK-DDİŞ-004	32	1"	16	0,19 kg	60	8,66 €
PVCRAK-DDİŞ-003	40	1 ¼"	16	0,31 kg	50	16,55 €
PVCRAK-DDİŞ-002	50	1 ½"	16	0,455 kg	30	22,34 €
PVCRAK-DDİŞ-001	63	2"	16	0,765 kg	15	35,84 €

UV dayanımlı polietilen gövde.

UV-resistant polyethylene body.

Yapıştırma Muflu 90° Dirsek U-PVC Solvent Cement 90° Elbow



KOD CODE	ÇAP Ø mm DIA Ø mm	BASINÇ PN	AĞIRLIK WEIGHT	KOLİ-ADET BOX-PCS	FİYAT PRICE
165002022	20	16	0,01 kg	400	0,23 €
165002026	25	16	0,02 kg	200	0,28 €
165002030	32	16	0,02 kg	100	0,42 €
165002032	40	16	0,05 kg	60	0,81 €
165002034	50	16	0,09 kg	80	0,82 €
165002036	63	16	0,18 kg	60	1,03 €
165002038	75	16	0,31 kg	200	1,97 €
165002040	90	16	0,55 kg	100	2,73 €
165002012	110	16	0,75 kg	15	4,62 €
165002014	125	16	1,15 kg	8	7,21 €
165002016	140	16	1,53 kg	6	10,67 €
165002019	160	16	2,25 kg	4	13,81 €
165002021	200	16	4,65 kg	2	33,61 €
165002024	225	10	4,83 kg	1	48,95 €
165002025	250	10	6,97 kg	1	123,20 €
165002027	280	10	8,55 kg	1	192,50 €
165002028	315	10	12,3 kg	1	217,80 €
16521002005	355	10	17,5 kg	1	645,46 €
165002156	400	10	23,50 kg	1	646,87 €

UV dayanımlı polietilen gövde.
UV-resistant polyethylene body.

U-PVC 45° Yapıştırma Muflu Dirsek U-PVC 45° Solvent Cement Elbow



KOD CODE	ÇAP Ø mm DIA Ø mm	BASINÇ PN	AĞIRLIK WEIGHT	KOLİ-ADET BOX-PCS	FİYAT PRICE
165002186	20	16	0,01 kg	400	0,23 €
165002103	25	16	0,01 kg	200	0,27 €
165002029	32	16	0,02 kg	100	0,41 €
165002031	40	16	0,04 kg	75	0,76 €
165002033	50	16	0,07 kg	80	0,79 €
165002035	63	16	0,13 kg	50	0,93 €
165002037	75	16	0,20 kg	40	1,88 €
165002039	90	16	0,34 kg	25	2,54 €
165002011	110	16	0,63 kg	18	4,46 €
165002013	125	16	0,91 kg	8	6,88 €
165002018	140	16	1,35 kg	6	9,85 €
165002020	160	16	2,00 kg	5	13,75 €
165002023	200	16	3,70 kg	2	29,48 €
165002105	225	10	4,00 kg	2	48,40 €
165002025	250	10	5,47 kg	2	105,60 €
165002157	280	10	7,51 kg	1	176,00 €
165002196	315	10	9,2 kg	1	188,10 €
165122014	355	10	9,65 kg	1	524,70 €
165002155	400	10	5,00 kg	1	603,76 €

U-PVC Yapıştırma Muflu Te U-PVC Solvent Cement Te



KOD CODE	ÇAP Ø mm DIA Ø mm	BASINÇ PN	AĞIRLIK WEIGHT	KOLİ-ADET BOX-PCS	FİYAT PRICE
165002083	20	16	0,02 kg	200	0,28 €
165002084	25	16	0,04 kg	100	0,32 €
165002085	32	16	0,07 kg	60	0,65 €
165002086	40	16	0,11 kg	90	0,91 €
165002087	50	16	0,12 kg	130	0,93 €
165002088	63	16	0,22 kg	50	1,31 €
165002089	75	16	0,33 kg	30	2,31 €
165002090	90	16	0,60 kg	18	3,57 €
PVCTE-110	110	16	1,05 kg	15	5,62 €
PVCTE-125	125	16	2,09 kg	6	8,86 €
PVCTE-140	140	16	2,18 kg	4	14,30 €
PVCTE-160	160	16	3,30 kg	3	19,69 €
PVCTE-200	200	16	4,57 kg	1	35,20 €
PVCTE-225	225	10	6,50 kg	1	66,00 €
PVCTE-250	250	10	8,92 kg	1	136,40 €
PVCTE-280	280	10	11,3 kg	1	209,00 €
PVCTE-315	315	10	16,4 kg	1	242,55 €
16521002001	355	10	23,60 kg	1	728,04 €
16521002002	400	10	28,01 kg	1	759,60 €

UV dayanımlı polietilen gövde.

UV-resistant polyethylene body.

UH-PVC Yapıştırma Muflu İnegal Te U-PVC Solvent Cement Reducing Te



KOD CODE	ÇAP Ø mm DIA Ø mm	BASINÇ PN	AĞIRLIK WEIGHT	KOLİ-ADET BOX-PCS	FİYAT PRICE
16521002026	32-25	16	0,08 kg	100	0,76 €
16521002025	40-32	16	0,13 kg	48	1,06 €
PVCTE-50/32/50-İNEGAL	50-32	16	0,14 kg	75	1,26 €
PVCTE-63/50/63	63-50	16	0,29 kg	30	2,31 €
16521002003	75-50	16	--	30	3,20 €
PVCTE75/63/75	75-63	16	0,45 kg	30	3,26 €
PVCTE-90/50/90-İNEGAL	90-50	16	--	35	4,52 €
PVCTE-90/63	90-63	16	0,64 kg	35	4,57 €
PVCTE-110/75	110-75	16	0,93 kg	10	6,82 €
PVCTE-110/90	110-90	16	0,98 kg	11	7,15 €
PVCTE-125/75/125-İNEGAL	125-75	16	1,71 kg	10	14,04 €
PVCTE-140/75/140-İNEGAL	140-75	16	2,54 kg	6	19,77 €
PVCTE-160/75/160-İNEGAL	160-75	16	2,70 kg	5	22,70 €
PVCTE 160/125/160 İNEGAL	160-125	16	4,15 kg	5	23,95 €
PVCTE-200/75/200-İNEGAL	200-75	16	4,30 kg	2	38,25 €
PVCTE-200/90/200-İNEGAL	200-90	16	4,29 kg	2	37,96 €
165002152	225-110	16	4,32 kg	2	60,06 €

UV dayanımlı polietilen gövde.

UV-resistant polyethylene body.

UH-PVC Dış Y.M. İç Diş Redüksiyonlu Adaptör

UH-PVC One Side Female Threaded Reducer Adaptor

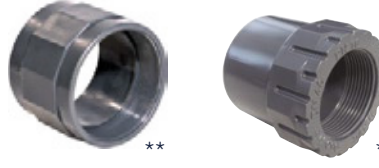

KOD CODE	ÇAP Ø mm DIA Ø mm	RP INCH	BASINÇ PN	AĞIRLIK WEIGHT	KOLİ-ADET BOX-PCS	FİYAT PRICE
165002065	*20	½"	16	0,01 kg	450	0,25 €
165002066	*25	¾"	16	0,02 kg	240	0,28 €
165002067	*32	1"	16	0,03 kg	180	0,32 €
165002068	*40	1 ¼"	16	0,06 kg	80	0,63 €
165002069	*50	1 ½"	16	0,13 kg	100	0,89 €
165002070	*63	2"	16	0,17 kg	75	1,26 €
165002071	**75	2 ½"	10	0,24 kg	75	1,94 €
165002072	**90	3"	10	0,31 kg	60	2,42 €
165002082	**110	4"	10	0,47 kg	18	3,89 €
165002183	**125	4 ½"	10	0,86 kg	22	9,68 €
165002192	**140	5"	10	1,06 kg	16	10,37 €
165002104	**160	6"	10	1,56 kg	12	15,57 €

UV dayanımlı polietilen gövde.

UV-resistant polyethylene body.

UH-PVC Dıştan Dişli Redüksiyonlu Adaptör

UH-PVC Side Female Threaded Reducer Adaptor



KOD CODE	ÇAP Ø mm DIA Ø mm	RP INCH	BASINÇ PN	KOLİ-ADET BOX-PCS	FİYAT PRICE
165002073	20	½"	16	400	0,24 €
165002074	25	¾"	16	250	0,30 €
165002075	32	1"	16	160	0,35 €
165002076	40	1 ¼"	16	120	0,74 €
165002077	50	1 ½"	16	150	0,95 €
165002078	63	2"	16	100	1,42 €
165002079	75	2 ½"	16	48	1,94 €
165002080	90	3"	16	27	3,31 €
165002081	110	4"	16	26	4,25 €

UH-PVC Yapıştırma Muflu 90° Kruva UH-PVC Solvent Cement 90° Cross



KOD CODE	ÇAP Ø mm DIA Ø mm	BASINÇ PN	AĞIRLIK WEIGHT	KOLİ-ADET BOX-PCS	FİYAT PRICE
PVCKURUVA-YAP-32	32	16	0,09 kg	110	2,50 €
PVCKURUVA-YAP-40	40	16	0,14 kg	70	2,99 €
PVCKURUVA-YAP-50	50	16	0,22 kg	35	3,47 €
PVCKURUVA-YAP-63	63	16	0,37 kg	40	5,78 €
PVCKURUVA-YAP-75	75	16	0,55 kg	20	6,83 €
PVCKURUVA-YAP-90	90	16	0,96 kg	12	8,61 €
PVCKURUVA-YAP-110	110	16	1,62 kg	7	16,80 €
PVCKURUVA-YAP-125	125	16	2,35 kg	4	28,49 €
PVCKURUVA-YAP-140	140	16	2,52 kg	4	44,55 €
PVCKURUVA-YAP-160	160	16	3,95 kg	3	57,31 €
PVCKURUVA-YAP-200	200	16	5,02 kg	1	126,50 €

UH-PVC Yapıştırma Muflu Manşon UH-PVC Double Socket



KOD CODE	ÇAP Ø mm DIA Ø mm	BASINÇ PN	AĞIRLIK WEIGHT	KOLİ-ADET BOX-PCS	FİYAT PRICE
165002053	20	16	0,01 kg	480	0,17 €
165002133	25	16	0,02 kg	250	0,21 €
165002054	32	16	0,01 kg	125	0,24 €
PVCMANŞON-40	40	16	0,03 kg	140	0,40 €
165002055	50	16	0,06 kg	70	0,41 €
165002056	63	16	0,11 kg	120	0,64 €
165002057	75	16	0,17 kg	90	1,30 €
165002058	90	16	0,30 kg	40	1,64 €
165002059	110	16	0,48 kg	28	2,77 €
165002060	125	16	0,7 kg	22	3,60 €
165002061	140	16	0,9 kg	16	4,25 €
165002062	160	16	1,30 kg	12	6,36 €
165002063	200	16	2,15 kg	3	14,30 €
165002064	225	16	3,79 kg	2	22,94 €
PVCMANŞON-250	250	16	4,00 kg	1	39,16 €
165002106	280	16	7,60 kg	1	62,00 €
165002199	315	16	6,98 kg	1	76,89 €
165002107	400	16	11,60 kg	1	322,08 €

UH-PVC Yapıştırma Muflu Kör Tapa UH-PVC Solvent Cement End Cap

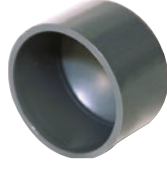

KOD CODE	ÇAP Ø mm DIA Ø mm	BASINÇ PN	AĞIRLIK WEIGHT	KOLİ-ADET BOX-PCS	FİYAT PRICE
PVCKÖR-20	20	16	0,008 kg	700	0,18 €
PVCKÖR-25	25	16	0,01 kg	600	0,22 €
PVCKÖR-32	32	16	0,02 kg	350	0,28 €
PVCKÖR-40	40	16	0,04 kg	250	0,35 €
PVCKÖR-50	50	16	0,05 kg	100	0,53 €
PVCKÖR-63	63	16	0,08 kg	100	0,63 €
PVCKÖR-75	75	16	0,17 kg	60	1,07 €
PVCKÖR-90	90	16	0,34 kg	35	1,37 €
PVCKÖR-110	110	16	0,34 kg	25	2,00 €
PVCKÖR-125	125	16	0,46 kg	15	3,41 €
PVCKÖR-140	140	16	0,82 kg	10	4,29 €
PVCKÖR-160	160	16	1,16 kg	8	7,81 €
PVCKÖR-200	200	16	1,46 kg	8	12,43 €
PVCKÖR-225	225	16	2,31 kg	6	20,90 €
PVCKÖR-250	250	10	2,87 kg	2	31,90 €
PVCKÖR-280	280	10	4,81 kg	2	45,10 €
PVCKÖR-315	315	10	5,87 kg	1	59,40€
16521002008	400	10	16,02 kg	1	319,78 €

Boru Kelepçesi Püpe Clamp



KOD CODE	ÇAP Ø mm DIA Ø mm	AĞIRLIK WEIGHT	FİYAT PRICE
PVCKEL-20	20	0,004 kg	0,08 €
PVCKEL-25	25	0,006 kg	0,09 €
PVCKEL-32	32	0,007 kg	0,14 €
PVCKEL-40	40	0,016 kg	0,16 €
PVCKEL-50	50	0,22 kg	0,22 €
PVCKEL-63	63	0,029 kg	0,46 €
PVCKEL-75	75	0,035 kg	0,58 €
PVCKEL-90	90	0,122 kg	0,89 €
PVCKEL-110	110	0,062 kg	0,91 €
PVCKEL-125	125	0,114 kg	1,42 €
PVCKEL-160	160	0,240 kg	2,44 €
PVCKEL-200	200	--	3,33 €

UH-PVC Yapıştırma Muflu Redüksiyon UH-PVC Solvent Cement Reducer



KOD CODE	ÇAP Ø mm DIA Ø mm	BASINÇ PN	AĞIRLIK WEIGHT	KOLİ-ADET BOX-PCS	FİYAT PRICE
165002137	20-16	16	0,004 kg	1500	0,18 €
165002119	25-20	16	0,004 kg	1000	0,11 €
165002120	32-20	16	0,01 kg	500	0,18 €
165002122	40-32	16	0,01 kg	300	0,15 €
165002123	50-32	16	0,03 kg	200	0,37 €
165002124	50-40	16	0,02 kg	200	0,30 €
165002125	63-32	16	0,07 kg	100	0,65 €
PVCRED-63/40	63-40	16	0,07 kg	100	0,78 €
165002126	63-50	16	0,05 kg	100	0,47 €
165002127	75-63	16	0,07 kg	60	0,46 €
PVCRED-90/50	90-50	16	0,14 kg	70	1,25 €
PVCRED-90/63	90-63	16	0,14 kg	70	0,81 €
165002128	90-75	16	0,13 kg	70	0,67 €
PVCRED-110/63	110-63	16	0,26 kg	40	1,98 €
PVCRED-110/75	110-75	16	0,27 kg	40	1,86 €
165002129	110-90	16	0,26 kg	40	1,59 €
PVCRED-125/90	125-90	16	0,38 kg	25	2,64 €
165002202	140-63	16	0,525 kg	35	5,61 €
PVCRED-140/110	140-110	16	0,50 kg	33	2,74 €
165002131	140-125	16	0,294 kg	25	1,84 €
PVCRED-160/90	160-90	16	0,70 kg	12	6,27 €
PVCRED-160/110	160-110	16	0,076 kg	15	4,51 €
165002132	160-140	16	0,56 kg	15	2,42 €

UH-PVC Yapıştırma Muflu Borular UH-PVC Solvent Cement Socketed Pressure Pipes



KOD CODE	ÇAP Ø mm DIA Ø mm	BASINÇ PN	AĞIRLIK WEIGHT	FİYAT PRICE
16519002007	20	16	0,138 kg	0,63 \$
16519002010	25	10	0,165 kg	0,75 \$
16519002013	32	10	0,241 kg	1,10 \$
16519002016	40	10	0,353 kg	1,61 \$
16519002019	50	10	0,561 kg	2,56 \$
16519002020	63	10	0,871 kg	3,97 \$
16519002021	75	10	1,245 kg	5,68 \$
16519002022	90	10	1,784 kg	8,14 \$
16519002001	110	10	2,160 kg	9,85 \$
16519002002	125	10	2,782 kg	12,69 \$
16519002003	140	10	3,512 kg	16,01 \$
16519002004	160	10	4,607 kg	21,01 \$
16519002006	200	10	7,123 kg	32,48 \$
16519002008	225	10	8,957 kg	40,84 \$
16519002009	250	10	11,119 kg	50,70 \$

PVC Yapıştırıcılar PVC Cements

KIPSOL

U-PVC Yapıştırıcı U-PVC Solvent

Öne Çıkan Özellikler Product Features

- » PVC montaj parçalarının yapıştırılmasında kullanılır
- » Temiz ve pis su hatlarında sızdırmaz bağlantı sağlar
- » Kapaktaki fırça ile kolay uygulanır
- » Akışkan yapısı sayesinde ekonomik sarfiyat sunar
- » Used for bonding PVC installation parts
- » Ensures leak-proof joints in clean and waste water lines
- » Easy to apply with brush integrated in the cap
- » Fluid consistency reduces material consumption



KOD CODE	MİKTAR QUANTITY	FİYAT PRICE
16520113001	1 Kg	25 €

PVC BORUSUNA NASIL UYGULANIR?

- Yapıştırılacak yüzeyler temizleyici sıvı ile toz, yağ ve kirden arındırılır.
- Muf boyuna göre işaretleme yapılır.
- Yüzeyler zımparalanıp tekrar temizlenir ve kurulanır.
- Her iki parçaya da fırça ile yapıştırıcı sürülür, fazla ürün kutuya geri alınır.
- Parçalar gecikmeden, döndürülmeden birleştirilir.
- Taşan yapıştırıcı temizlenir.

U-PVC Yapıştırıcı

U-PVC Solvent

Öne Çıkan Özellikler Product Features

» THF içermez

Daha güvenli kullanım sunan, REACH uyumlu formül

» Hızlı ve güçlü yapışma

Yüksek ilk tutunma gücü sayesinde kısa sürede sağlam bağlantı sağlar

» Tikotropik (akma yapmayan) yapı

Dikey uygulamalarda sarkma ve damlama riskini azaltır

» Yüksek basınç dayanımı

Basınçlı PVC boru sistemlerinde güvenle kullanılır (su ve gaz tesisatları dahil)

» Tek bileşenli, kullanıma hazır

Karışım gerektirmeden pratik ve hızlı uygulama imkânı sunar

» Profesyonel tesisatlar için geliştirilmiştir

Su temini, sulama, drenaj ve endüstriyel PVC boru sistemlerine uygundur

» THF-free formulation

REACH-compliant formula provides safer handling and use

» Fast and strong bonding

High initial bond strength ensures quick and durable joints

» Thixotropic, non-drip consistency

Prevents sagging and dripping, especially in vertical applications

» High pressure resistance

Suitable for pressurized U-PVC piping systems

» Single-component, ready to use

No mixing required for fast and easy application

» Designed for professional installations

Ideal for water supply, irrigation, drainage and industrial PVC systems

Nasıl kullanılır izlemek için QR kodu okutun.

Scan the QR code to watch how to use.



ULTIMA PLUS

Daha kısa açık bekleme süresi ile ultra hızlı yapışma
Ultra-fast bonding with shorter open time



TIXO

Kontrollü uygulama ve montaj esnekliği
Controlled application with flexible installation time

KOD CODE	TANIM DESCRIPTION	MİKTAR QUANTITY	FİYAT PRICE
16520122007	1000 Cc Kefren Ultima Plus	1 lt	18,50 €

KOD CODE	TANIM DESCRIPTION	MİKTAR QUANTITY	FİYAT PRICE
16520122008	1000 Cc Kefren Tixo	1 lt	16,50 €



K-21

PVC temizleyici
PVC Cleaner

» K-21 temizleyici 500 ml hacme sahiptir

Uygulama öncesi yüzey hazırlığında pratik ve yeterli kullanım sunar

» Yüksek katı madde oranı (%27)

Rakiplerine göre daha yoğun formülü sayesinde daha az ürünle daha güçlü yapışma sağlar

» ISO 9001 Avrupa kalite standartlarına uygundur

Üretim süreci kalite sertifikalıdır; kullanılan çözücüler sağlığa zarar vermez

» Quantity stated in liters

The PVC adhesive is supplied in 1 liter packaging

(equivalent to approx. 960 g).K-21 cleaner is available in 500 ml format (approx. 460 g)

» High solid content (27%)

Higher concentration compared to competitors ensures stronger bonding with less adhesive – offering greater efficiency.

» Complies with ISO 9001 European quality standards

Our adhesives are produced under certified quality systems, using solvents that are safe for professional use.

KOD CODE	TANIM DESCRIPTION	MİKTAR QUANTITY	FİYAT PRICE
16520122006	Kefren K-21	0,50 lt	15 €

hemenhavuz

1 GÜNDE KURULUM

BİRBİRİNDEN ÇEŞİTLİ
FIBERGLASS HAVUZ MODELLERİNİ
HEMENHAVUZ.COM İLE KEŞFEDİN!



JAKUZİ KEYFİ

Dilerseniz havuz ve SPA
sonsuz yüzme
havuzunuzda sizinle!



BETONERME GEREKTİRMEZ

Uzun süren inşaat
süreçlerine gerek olmadan
kısada sürede sizinle!



DÜŞÜK MALİYETLİ

Düşük kimyasal kullanımı
özellği ve düşük elektrik
maliyeti ile bütçeye dost!

hemenhavuz.com

hemenhavuz

INSTALLATION IN 1 DAY

DISCOVER VARIOUS
FIBERGLASS POOL MODELS
WITH [HEMENHAVUZ.COM!](https://www.hemenhavuz.com)



JACUZZI ENJOYMENT

If you wish, the pool and SPA are with you in the endless swimming pool.



DOES NOT REQUIRE REINFORCED CONCRETE

It will be with you in a short time, without the need for long construction processes.



LOW COST

It is budget-friendly with its low chemical usage and low electricity cost.

[hemenhavuz.com](https://www.hemenhavuz.com)



KALİTE BELGELERİMİZ & SERTİFİKALARIMIZ



BELGELER İÇİN TARAYINIZ
FOR OUR ALL DOCUMENTS





OUR QUALITY DOCUMENTS & CERTIFICATES



BELGELER İÇİN TARAYINIZ
FOR OUR ALL DOCUMENTS



YEDEK PARÇALAR SPARE PARTS

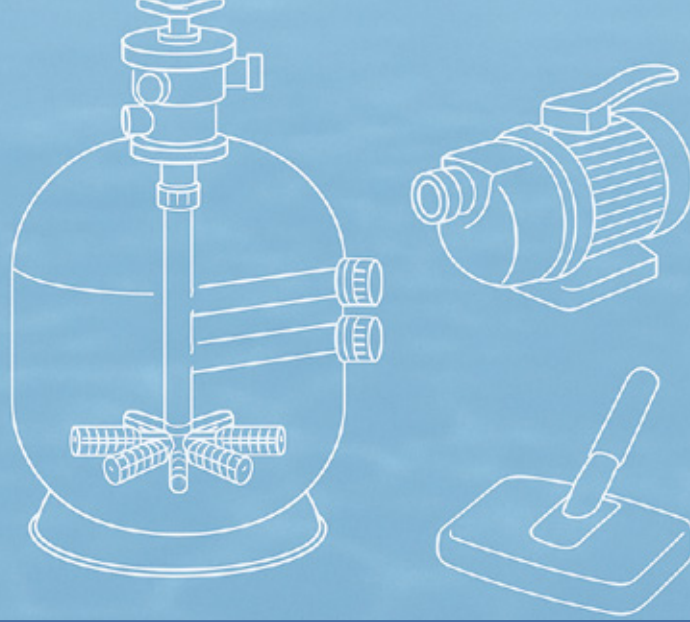

HAVUZ EKİPMANLARI YEDEK PARÇALARI POOL EQUIPMENT SPARE PARTS

*Bakım, onarım ve performans için orijinal yedek parçalar.
Original spare parts for maintenance, repair and performance.*

Havuz sistemleriniz için gerekli tüm orijinal yedek parçalar tek yerde..
All essential original spare parts for your pool systems in one place.

Uzun ömürlü sistemler için doğru parça, doğru çözüm.
Filtre, pompa, havuz robotları ve süpürge sistemleriniz için orijinal parça çözümleriyle, uzun ömürlü performans sağlarız.

*The right part, the right solution for long-lasting systems.
We provide long-lasting performance with original parts solutions for your filter, pump and vacuum systems.*

SENKRON 1 POMPA YEDEK PARÇALARI SPARE PARTS OF SENKRON 1 PUMP

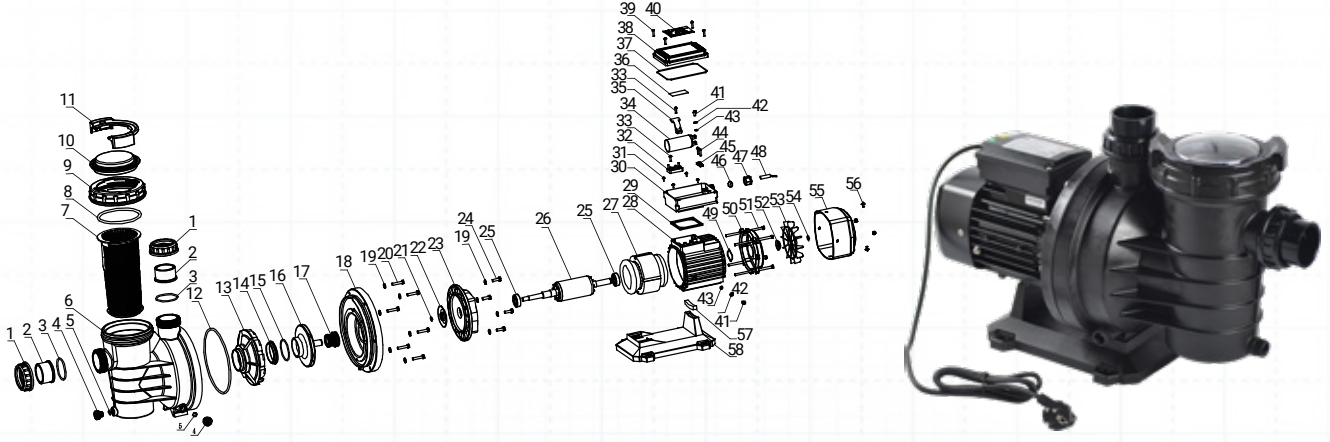

Parça Part	Açıklama Description	Stok Kodu Code
1	Rakor somunu Union (Tie In) nut	19810123027
2	Rakor Union (Tie In)	19810123007
3	Rakor oringi Union oring	19810123028
4	Gider tıpası Drainage plug	19810123029
5	Gider tapası oringi Plug oring	19810123030
6	Ön filtre kasası Pre-filter pump casing	19810123041
7	Ön filtre sepeti Pre-filter basket	19810123025
8	Ön filtre kapak oringi Pre-filter cover oring	19810123024
9	Ön filtre kapak bileziği Pre-filter cover ring	19810123022
10	Ön filtre şeffaf kapağı Pre-filter lid transparent	19810123023
11	Kapak anahtarı Cover key	19810123044
12	Gövde oringi Body oring	19810123031
13	Difüzör Diffuser	19810123033
14	Aktif ring Active ring	19810123034
15	Difüzör Oringi Diffuser Oring	19810123032
16	Fan 0,50 Hp Impeller 0,50 Hp	19810123035
	Fan 0,75 Hp Impeller 0,75 Hp	19810123045
	Fan 1,00 Hp Impeller 1,00 Hp	19810123036
	Fan 1,00 Hp Tri Impeller 1,00 Hp Tri	19810123070
	Fan 1,50 Hp Impeller 1,50 Hp	19810123031
17	Mekanik salmastra Mechanical seal	PMS-SYMS7
18	Gövde Body	19810123026
23	Flanş Flange	19810123048
53	Arka soğutma fanı Cooling fan	PMS-SYMS3
55	Arka soğutma fan kapağı Cooling fan cover	PMS-SYMS5
58	Yer desteği Base support	19810123039

SENKRON 2 POMPA YEDEK PARÇALARI SPARE PARTS OF SENKRON 2 PUMP

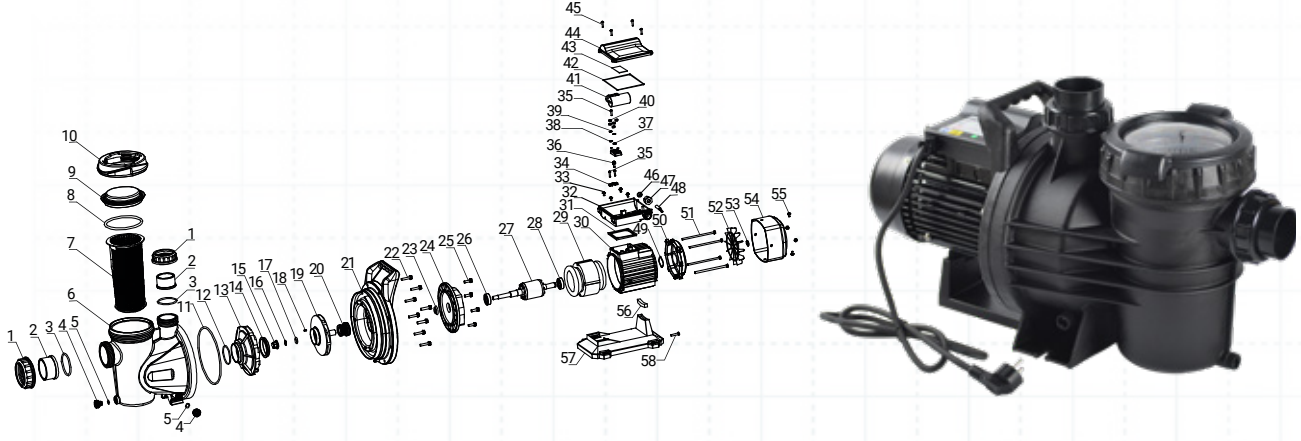

Parça Part	Açıklama Description	Stok Kodu Code
1	Rakor somunu Union (Tie In) nut	19810123008
2	Rakor Union (Tie In)	19810123009
3	Rakor oringi Union oring	19810123010
4	Gider tıpası Drainage plug	19810123011
6	Ön filtre kasası Pre-filter pump casing	19810123042
7	Ön filtre sepeti Pre-filter basket	19810123005
8	Ön filtre kapak oringi Pre-filter cover oring	19810123004
9	Ön filtre şeffaf kapağı Pre-filter lid transparent	19810123003
10	Ön filtre kapak bileziği Pre-filter cover ring	19810123002
11	Gövde oringi Body oring	19810123012
12	Difüzör Oringi Diffuser Oring	19810123013
13	Difüzör Diffuser	19810123014
14	Aktif ring Active ring	19810123015
15	Fan somunu (Tie In) nut	19810123016
19	Fan 1,50 Hp Impeller 1,50 Hp	19810123068
	Fan 2,00 Hp Impeller 2,00 Hp	19810123017
	Fan 3,00 Hp Impeller 3,00 Hp	19810123019
	Fan 4,00 Hp Tri Impeller 4,00 Hp Tri	19810123067
20	Mekanik salmastra Mechanical seal	PMS-SYMS7
21	Gövde Body	19810123006
24	Flanş Flange	19810123066
52	Arka soğutma fanı Cooling fan	PMS-SYMS4
54	Arka soğutma fan kapağı Cooling fan cover	PMS-SYMS6
57	Yer desteği Base support	19810123021

SENKRON 3 POMPA YEDEK PARÇALARI SPARE PARTS OF SENKRON 3 PUMP

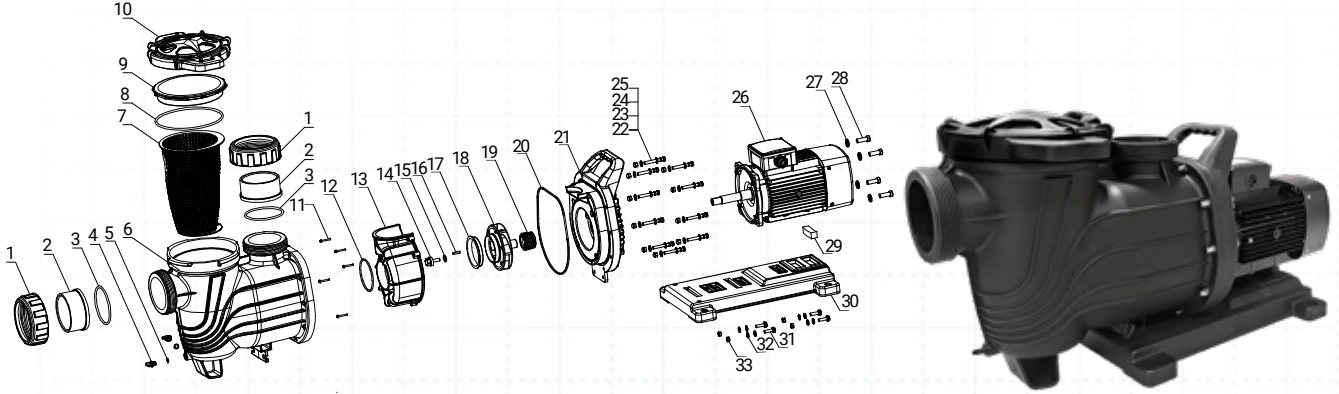

Parça Part	Açıklama Description	Stok Kodu Code
1	Rakor somunu Union (Tie In) nut	19810123113
2	Rakor 90 mm Union (Tie In) 90 mm	19810123114
	Rakor 110 mm Union (Tie In) 110 mm	19810123115
3	Rakor oringi Union oring	19810123116
6	Ön filtre kasası Pre-filter pump casing	19810123117
7	Ön filtre sepeti Pre-filter basket	19810123095
8	Ön filtre kapak oringi Pre-filter cover oring	19810123096
9	Ön filtre şeffaf kapağı Pre-filter lid transparent	19810123097
10	Ön filtre kapak somunu Pre-filter cover nut	19810123098
14	Fan somunu Impeller nut	19810123099
17	Aktif ring Active ring	19810123100
18	Fan 4,50 Hp Impeller 4,50 Hp	19810123112
	Fan 5,50 Hp Impeller 5,50 Hp	19810123101
19	Mekanik salmastra set Mechanical seal set	19810123103
21	Flanş Flange	19810123122
30	Yer desteği Base support	19810123104

SENKRON 3 JET POMPA YEDEK PARÇALARI SPARE PARTS OF SENKRON 3 JET PUMP

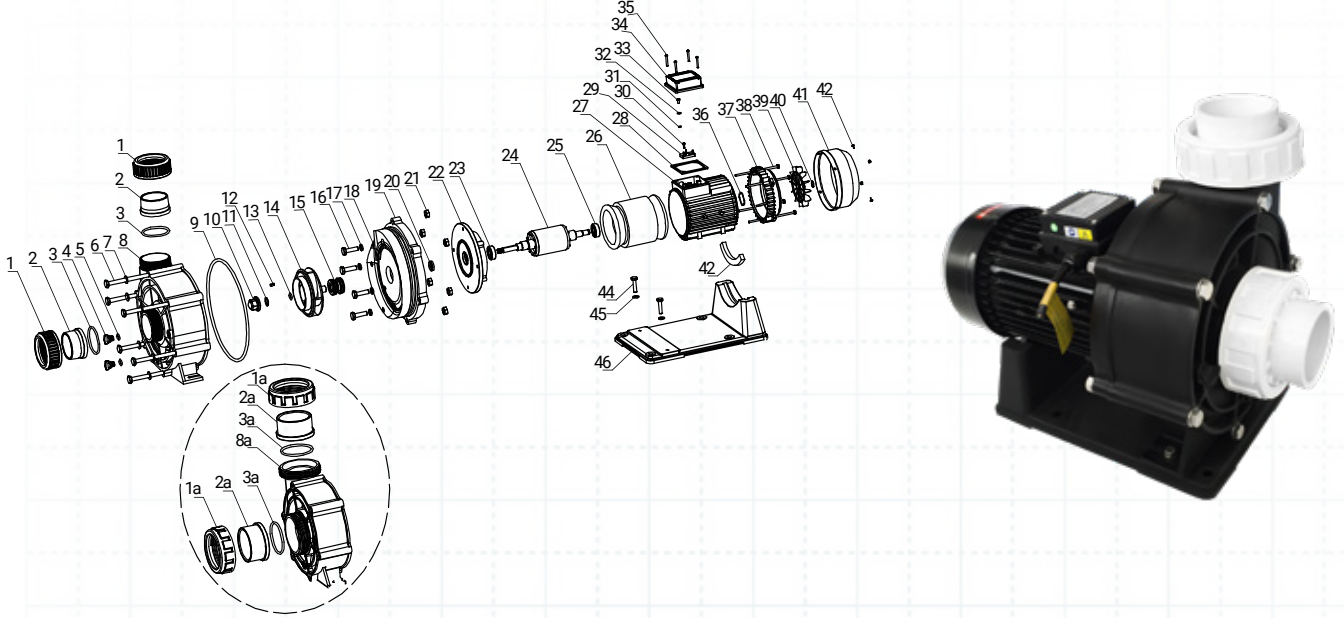

Parça Part	Açıklama Description	Stok Kodu Code
1	Rakor somunu <i>Union (Tie In) nut</i>	19810123105
2	Rakor <i>Union (Tie In)</i>	19810123106
3	Rakor oringi <i>Union oring</i>	19810123107
8	Ön filtre kasası <i>Pre-filter pump casing</i>	19810123108
9	Ön kasa oringi <i>Pump casing oring</i>	19810123109
10	Fan somunu <i>Impeller nut</i>	19810123110
14	Fan 3 Hp <i>Impeller 3 Hp</i>	19810123111
15	Mekanik salmastra set <i>Mechanical seal set</i>	19810123089
39	Arka soğutma fanı <i>Cooling fan</i>	19810123092
41	Arka soğutma fan kapağı <i>Cooling fan cover</i>	19810123093
46	Yer desteği <i>Base support</i>	19810123094

NINFA YEDEK PARÇALARI SPARE PARTS OF NINFA PUMP

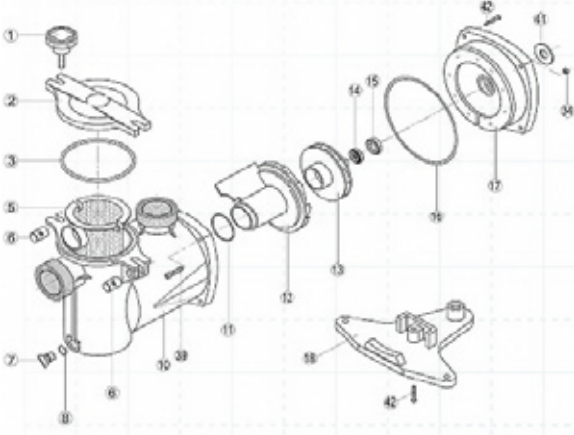

Parça Part	Açıklama Description	Referans Reference	Stok Kodu Code	Adet Qty
7	Gider takımı <i>Drain set</i>	RBH0000.00R	198113038	No:0-1 Ad Unit
1	Kapak vidası seti <i>Cover screw set</i>	RBH0001.00R	PÖFKV-OK-KRP	No:1-2 Ad Unit + No:16-2 Ad Unit
6	Somun <i>Pin</i>	RBH0016.00R	198113037	No:16-1 Ad Unit
2+3	Ön filtre kapak ve oringi <i>Lid and O-ring</i>	RBH0002.00R	198113002	No:2-1 Ad Unit + No:11-1 Ad Unit
5	Ön filtre sepeti <i>Basket</i>	RBH0003.00R	198113004	No:3-1 Ad Unit
14+15	Mekanik salmastra seti <i>Seal set</i>	RBH0005.00R	198113012	No:5-1 Ad Unit + No:12-1 Ad Unit + No:13-1 Ad Unit
12	Difüzör 0,25/0,33 Hp <i>Diffuser 0,25/0,33Hp</i>	RBH0006.00R	198113009	No:6-1 Ad Unit
13	Fan 0,25 Hp <i>Impeller 0,25 Hp</i>	RBH0007.00R	198113010	No:7-1 Ad Unit
13	Fan 0,33 Hp <i>Impeller 0,33 Hp</i>	RBH0007.01R	198113011	No:7-1 Ad Unit
17	Flanş <i>Flange</i>	RBH0008.00R	198113014	No:8-1 Ad Unit
18	Yer desteği <i>Support</i>	RBH0009.00R	198113015	No:9-1 Ad Unit
10	Pompa kasası <i>Pump casing</i>	RBH0010.00R	198113007	No:10-1 Ad Unit
3	Ön filtre kapak oringi <i>Lid O-ring</i>	RBH0011.00R	198113003	No:11-1 Ad Unit
16	Difüzör oringi <i>Diffuser O-ring</i>	RBH0012.00R	198113008	No:12-1 Ad Unit
11	Flanş oringi <i>Flange O-ring</i>	RBH0013.00R	198113013	No:13-1 Ad Unit

ONDINA YEDEK PARÇALARI SPARE PARTS OF ONDINA PUMP

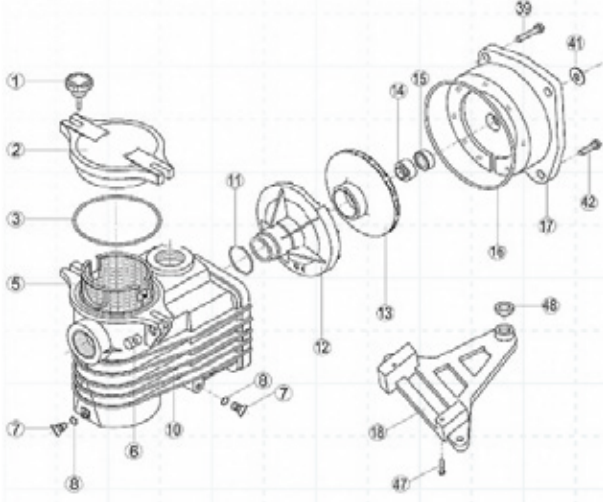

Parça Part	Açıklama Description	Referans Reference	Stok Kodu Code	Adet Qty
0	Gider takımı <i>Drain set</i>	RBH0000.00R	198113038	No:0-1 Ad Unit
1+16	Kapak vidası seti <i>Cover screw set</i>	RBH0001.01R	PÖFKV-OK-KRP	No:1-2 Ad Unit + No:16-2 Ad Unit
16	Somun <i>Pin</i>	RBH0016.00R	198113037	No:16-1 Ad Unit
2+11	Ön filtre kapak ve oringi <i>Lid and O-ring</i>	RBH0002.01R	198113017	No:2-1 Ad Unit + No:11-1 Ad Unit
3	Ön filtre sepeti <i>Basket</i>	RBH0003.01R	198113019	No:3-1 Ad Unit
5+12+13	Mekanik salmastra seti <i>Seal set</i>	RBH0005.01R	PMS-OK	No:5-1 Ad Unit + No:12-1 Ad Unit + No:13-1 Ad Unit
6	Difüzör <i>Diffuser</i>	RBH0006.02R	198113024	No:6-1 Ad Unit
7	Fan 0,33 Hp <i>Impeller 0,33 Hp</i>	RBH0007.03R	198113029	No:7-1 Ad Unit
7	Fan 0,50 Hp <i>Impeller 0,50 Hp</i>	RBH0007.04R	198113104	No:7-1 Ad Unit
7	Fan 0,75 Hp <i>Impeller 0,75 Hp</i>	RBH0007.05R	198113048	No:7-1 Ad Unit
7	Fan 1,00 Hp <i>Impeller 1,00 Hp</i>	RBH0007.06R	198113032	No:7-1 Ad Unit
8	Flanş <i>Flange</i>	RBH0008.01R	198113027	No:8-1 Ad Unit
9	Yer desteği <i>Support</i>	RBH0009.01R	198113045	No:9-1 Ad Unit
10	Pompa kasası <i>Pump casing</i>	RBH0010.01R	198113022	No:10-1 Ad Unit
11	Ön filtre kapak oringi <i>Lid O-ring</i>	RBH0011.01R	198113018	No:11-1 Ad Unit
12	Difüzör oringi <i>Diffuser O-ring</i>	RBH0012.01R	198113023	No:12-1 Ad Unit
13	Flanş oringi <i>Flange O-ring</i>	RBH0013.01R	198113026	No:13-1 Ad Unit

KORAL SERİSİ YEDEK PARÇALARI SPARE PARTS OF KORAL SERIES PUMP

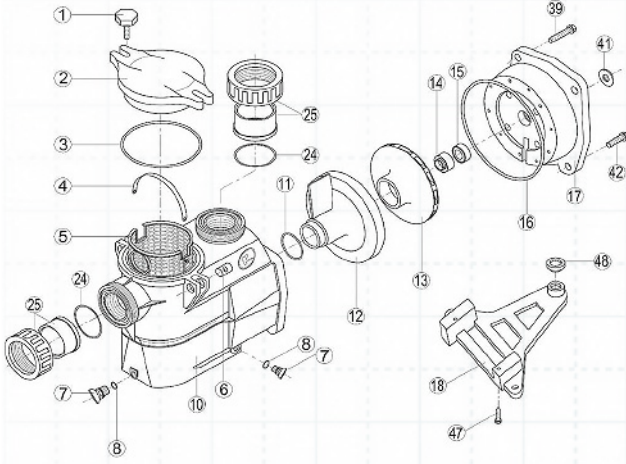

Parça Part	Açıklama Description	Referans Reference	Stok Kodu Code	Adet Qty
0	Gider takımı <i>Drain set</i>	RBH0000.00R	198113038	No:0-1 Ad Unit
1+16	Kapak vidası seti <i>Cover screw set</i>	RBH0001.02R	198113033	No:1-2 Ad Unit + No:16-2 Ad Unit
16	Somun <i>Pin</i>	RBH0016.00R	198113037	No:16-1 Ad Unit
2+11	Ön filtre kapak ve oringi <i>Lid and</i>	RBH0002.03R	198113034	No:2-1 Ad Unit + No:11-1 Ad Unit
3	Ön filtre sepeti <i>Basket</i>	RBH0003.03R	198113036	No:3-1 Ad Unit
5+12+13	Mekanik salmastra seti <i>Seal set</i>	RBH0005.01R	PMS-OK	No:5-1 Ad Unit + No:12-1 Ad Unit + No:13-1 Ad Unit
6	Difüzör <i>Diffuser</i>	RBH0006.03R	198113041	No:6-1 Ad Unit
7	Fan 0,33 Hp <i>Impeller 0,33 Hp</i>	RBH0007.03R	198113029	No:7-1 Ad Unit
7	Fan 0,50 Hp <i>Impeller 0,50 Hp</i>	RBH0007.07R	PFAN-KS-3350-KRP	No:7-1 Ad Unit
7	Fan 0,75 Hp <i>Impeller 0,75 Hp</i>	RBH0007.05R	198113048	No:7-1 Ad Unit
7	Fan 1,00 Hp <i>Impeller 1,00 Hp</i>	RBH0007.08R	PFAN-KS-5075-KRP	No:7-1 Ad Unit
7	Fan 1,50 Hp <i>Impeller 1,50 Hp</i>	RBH0007.09R	198113050	No:7-1 Ad Unit
7	Fan 2,00 Hp <i>Impeller 2,00 Hp</i>	RBH0007.10R	198113051	No:7-1 Ad Unit
7	Fan 3,00 Hp <i>Impeller 3,00 Hp</i>	RBH0007.11R	198113052	No:7-1 Ad Unit
8	Flanş <i>Flange</i>	RBH0008.02R	198113044	No:8-1 Ad Unit
9	Yer desteği <i>Support</i>	RBH0009.01R	198113044	No:9-1 Ad Unit
10	Pompa kasası <i>Pump casing</i>	RBH0010.03R	198113039	No:10-1 Ad Unit
11	Ön filtre kapak oringi <i>Lid O-ring</i>	RBH0011.03R	198113035	No:11-1 Ad Unit
12	Difüzör oringi <i>Diffuser O-ring</i>	RBH0012.02R	198113040	No:12-1 Ad Unit
13	Flanş oringi <i>Flange O-ring</i>	RBH0013.02R	198113043	No:13-1 Ad Unit

KARPA SERİSİ YEDEK PARÇALARI SPARE PARTS OF KARPA SERIES PUMPS

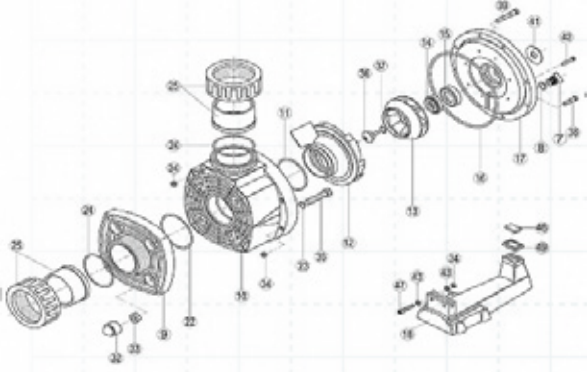

Parça Part	Açıklama Description	Referans Reference	Stok Kodu Code	Adet Qty
0	Gider takımı <i>Drain set</i>	RBH0000.00R	198113038	No:0-1 Ad Unit
5+12+13	Mekanik salmastra seti <i>Seal set</i>	RBH0005.02R	198113103	No:5-1 Ad Unit + No:12-1 Ad Unit + No:13-1 Ad Unit
6	Difüzör <i>Diffuser</i>	RBH0006.04R	198113062	No:6-1 Ad Unit
7	Fan 2,50 Hp <i>Impeller 2,50 Hp</i>	RBH0007.12R	198113070	No:7-1 Ad Unit
7	Fan 3,00 Hp <i>Impeller 3,00 Hp</i>	RBH0007.17R	198113071	No:7-1 Ad Unit
7	Fan 3,50 Hp <i>Impeller 3,50 Hp</i>	RBH0007.14R	198113072	No:7-1 Ad Unit
7	Fan 4,50 Hp <i>Impeller 4,50 Hp</i>	RBH0007.18R	198113073	No:7-1 Ad Unit
7	Fan 5,50 Hp <i>Impeller 5,50 Hp</i>	RBH0007.19R	198113150	No:7-1 Ad Unit
8	Flanş <i>Flange</i>	RBH0008.03R	198113065	No:8-1 Ad Unit
9	Yer desteği <i>Support</i>	RBH0009.02R	198113066	No:9-1 Ad Unit
10	Pompa kasası <i>Pump casing</i>	RBH0010.06R	198113060	No:10-1 Ad Unit
12	Difüzör oringi <i>Diffuser O-ring</i>	RBH0012.03R	198113061	No:12-1 Ad Unit
13	Flanş oringi <i>Flange O-ring</i>	RBH0013.03R	198113064	No:13-1 Ad Unit
17	Bağlantı rakor oringi <i>Union O-ring</i>	RBH0017.00R	198113068	No:17-1 Ad Unit

KAN SERİSİ YEDEK PARÇALARI SPARE PARTS OF KAN SERIES PUMP

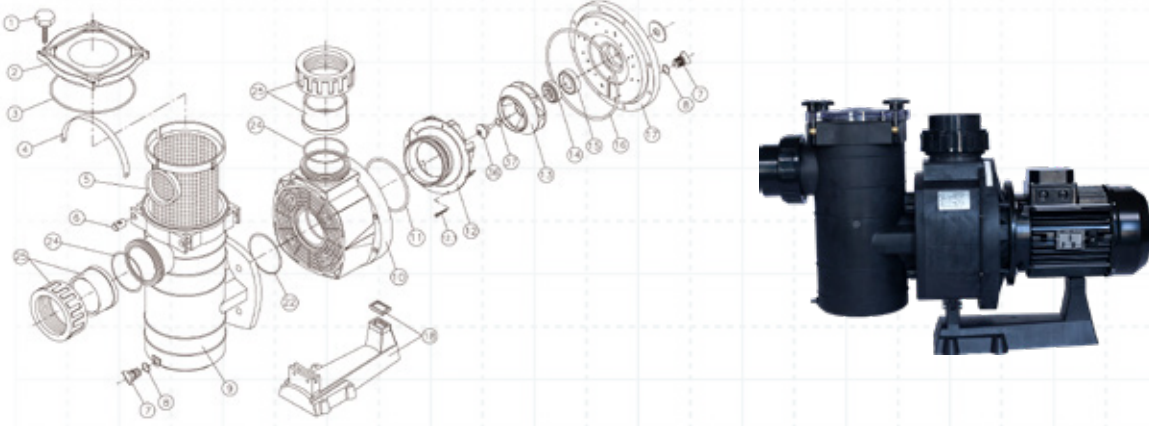

Parça Part	Açıklama Description	Referans Reference	Stok Kodu Code	Adet Qty
7+8	Gider takımı <i>Drain set</i>	RBH0000.00R	198113038	No:7-1 Ad Unit+ No:8-1 Ad Unit
1+6	Kapak vidası seti <i>Cover screw set</i>	RBH0001.04R	198113001	No:1-2 Ad Unit + No:6-2 Ad Unit
6	Somun <i>Pin</i>	RBH0016.01R	198113123	No:6-1 Ad Unit
2+3	Ön filtre kapak ve oringi <i>Lid and O-ring</i>	RBH0002.06R	198113092	No:2-1 Ad Unit + No:3-1 Ad Unit
4+5	Ön filtre sepeti <i>Basket</i>	RBH0003.06R	198113098	No:4-1 Ad Unit No:5-1 Ad Unit
14+15+11+16	Mekanik salmastra seti <i>Seal set</i>	RBH0005.02R	198113103	No:14-1 Ad Unit + No:15-1 Ad Unit + No:11-1 Ad Unit + No:16-1 Ad Unit
12+12.1	Difüzör 500-600-750 <i>Diffuser 500-600-750</i>	RBH0006.05R	198113087	No:12-1 Ad Unit
13+36+37	Difüzör 1000-1250 <i>Diffuser 100-1250</i>	RBH0006.06R	198113088	No:12.1-8 Ad Unit
	Fan 5,00 Hp <i>Impeller 5,00 Hp</i>	RBH0007.20R	198113146	No:13-1 Ad Unit
	Fan 6,00 Hp <i>Impeller 6,00 Hp</i>	RBH0007.21R	198113145	No:36-1 Ad Unit
	Fan 7,50 Hp <i>Impeller 7,50 Hp</i>	RBH0007.22R	198113091	No:37-1 Ad Unit
	Fan 10,00 Hp <i>Impeller 10,00 Hp</i>	RBH0007.23R	198113057	No:17-1 Ad Unit
	Fan 12,50 Hp <i>Impeller 12,50 Hp</i>	RBH0007.24R	198113140	
17	Flanş <i>Flange</i>	RBH0008.04R	198113085	No:18-1 Ad Unit
18	Yer desteği <i>Support</i>	RBH0009.02R	198113066	
10	Pompa kasası <i>Pump casing</i>	RBH0010.07R	198113108	
3	Ön filtre kapak oringi <i>Lid O-ring</i>	RBH0011.06R	198113005	No:3-1 Ad Unit
13	Flanş oringi <i>Flange O-ring</i>	RBH0012.04R	198113110	No:11-1 Ad Unit
11	Difüzör oringi <i>Diffuser O-ring</i>	RBH0013.04R	198113086	No:16-1 Ad Unit
16	Flanş oringi <i>Flange O-ring</i>	RBH0017.00R	198113110	No:22-1 Ad Unit
9	Ön filtre kasası <i>Prefilter</i>	RBH0015.02R	198113107	No:24-2 Ad Unit
24+25	Bağlantı rakor seti <i>Set of unions</i>		198113076	No:25-2 Ad Unit

KAPRI SERİSİ YEDEK PARÇALARI SPARE PARTS OF KAPRI SERIES PUMPS

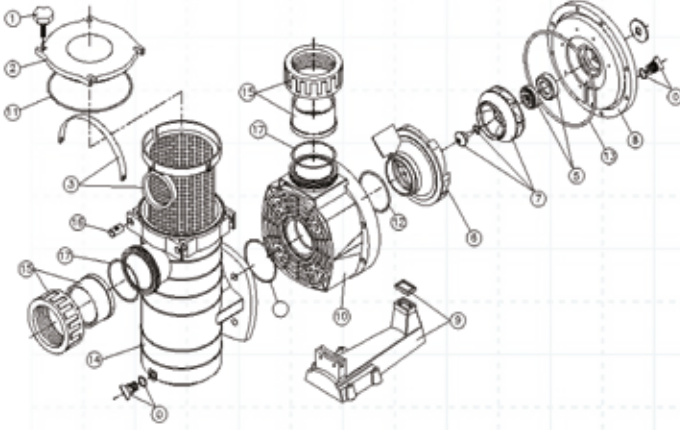

Parça Part	Açıklama Description	Referans Reference	Stok Kodu Code	Adet Qty
0	Gider takımı <i>Drain set</i>	RBH0000.00R	198113038	No:0-1 Ad Unit
1+16	Kapak vidası seti <i>Cover screw set</i>	RBH0001.02R	198113058	No:1-2 Ad Unit + No:16-2 Ad Unit
16	Somun <i>Pin</i>	RBH0016.00R	198113037	No:16-1 Ad Unit
2+11	Ön filtre kapak ve oringi <i>Lid and O-ring</i>	RBH0002.03R	198113054	No:2-1 Ad Unit + No:11-1 Ad Unit
3	Ön filtre sepeti <i>Basket</i>	RBH0003.03R	198113056	No:3-1 Ad Unit
5+12+13	Mekanik salmastra seti <i>Seal set</i>	RBH0005.01R	198113103	No:5-1 Ad Unit + No:12-1 Ad Unit + No:13-1 Ad Unit
6	Difüzör <i>Diffuser</i>	RBH0006.03R	198113062	No:6-1 Ad Unit
7	Fan 2,50 Hp <i>Impeller 2,50 Hp</i>	RBH0007.03R	198113070	No:7-1 Ad Unit
7	Fan 3,00 Hp <i>Impeller 3,00 Hp</i>	RBH0007.07R	198113071	No:7-1 Ad Unit
7	Fan 3,50 Hp <i>Impeller 3,50 Hp</i>	RBH0007.05R	198113072	No:7-1 Ad Unit
7	Fan 4,50 Hp <i>Impeller 4,50 Hp</i>	RBH0007.08R	198113073	No:7-1 Ad Unit
7	Fan 5,50 Hp <i>Impeller 5,50 Hp</i>	RBH0007.09R	198113074	No:7-1 Ad Unit
8	Flanş <i>Flange</i>	RBH0008.02R	198113065	No:8-1 Ad Unit
9	Yer desteği <i>Support</i>	RBH0009.01R	198113066	No:9-1 Ad Unit
10	Pompa kasası <i>Pump casing</i>	RBH0010.03R	198113060	No:10-1 Ad Unit
11	Ön filtre kapak oringi <i>Lid O-ring</i>	RBH0011.03R	198113055	No:11-1 Ad Unit
12	Difüzör oringi <i>Diffuser O-ring</i>	RBH0012.02R	198113061	No:12-1 Ad Unit
13	Flanş oringi <i>Flange O-ring</i>	RBH0013.02R	198113064	No:13-1 Ad Unit
17	Bağlantı rakor oringi <i>Union O-ring</i>	RBH0017.00R	198113068	No:17-1 Ad Unit
14	Ön filtre kasası <i>Prefilter</i>	RBH0014.00R	198113059	No:14-1 Ad Unit
15	Bağlantı rakoru set <i>Set of unions</i>	500100150000	198113069	No:15-1 Ad Unit

LAMEX FİLTRE YEDEK PARÇALARI SPARE PARTS OF LAMEX FILTER

500-900

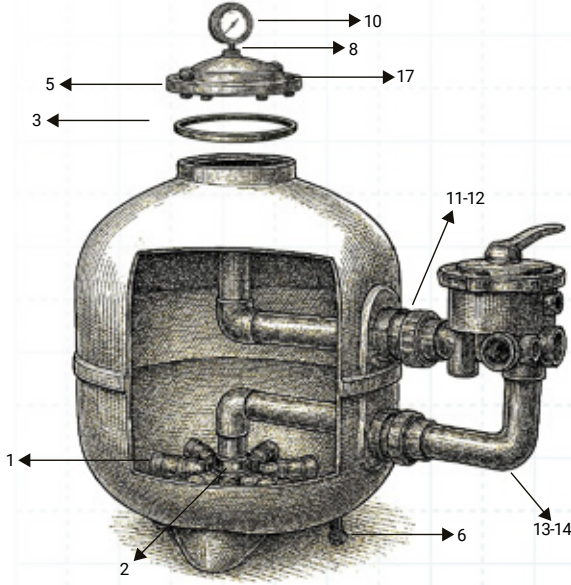

No	Stok Kodu Code	Açıklama Description
1	19811121001	Lateral 57 mm <i>Lateral 57 mm</i>
2	19811121318	Kollektör 500-650-800-900 mm <i>Replacement cover</i>
3	19811122003	Kapak oringi 500-900 mm <i>Cover oring 500-900 mm</i>
5	19811122013	Yedek kapak 500-900 mm <i>Replacement cover 500-900 mm</i>
6	19811123290	Boşaltma tapası <i>Filter drain plug</i>
8	19811002001	Filtre purjörü 500-900 mm <i>Filter air relase valve 500-900 mm</i>
10	19811122031	Manometre 500-900 mm <i>Manometer 500-900 mm</i>
11	19811122037	Rakor 50 mm <i>Union 50 mm</i>
12	19811122038	Rakor 63 mm <i>Union 63 mm</i>
13	19820223008	Vana 6 yollu L boru 50 mm <i>6-way valve, L pipe 50 mm</i>
14	19820223009	Vana 6 yollu L boru 63 mm <i>6-way valve, L pipe 63 mm</i>
15	19820223010	Vana 6 yollu bağlantı karşılığı 50 mm <i>Valve with 6-way connection, 50 mm counterpart</i>
16	19820223011	Vana 6 yollu bağlantı karşılığı 63 mm <i>Valve with 6-way connection, 63 mm counterpart</i>
17	19811123072	Filtre kapağı somunu plastik <i>Filter cover nut is plastic</i>

LAMEX FİLTRE YEDEK PARÇALARI SPARE PARTS OF LAMEX FILTER

1.050-2.200

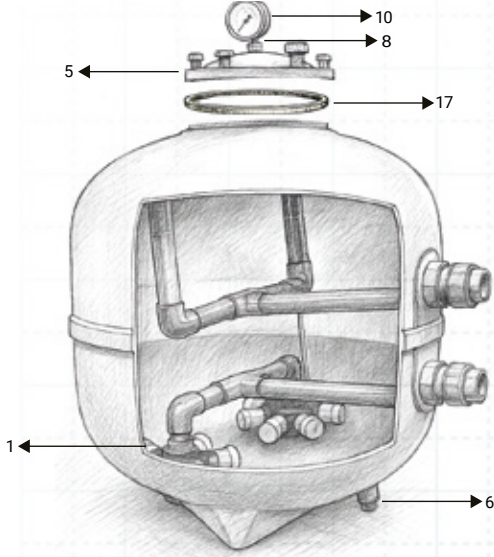

No	Stok Kodu Code	Açıklama Description
5	19811122017	Yedek kapak 1.050-2.200 mm Replacement cover 1.050-2.200 mm
8	19811002002	Filtre purjörü 1.050-2.200 mm Filter air relase valve 1.050-2.200 mm
10	19811122001	Manometre 1.050-2.200 mm Manometer 1.050-2.200 mm
1	19811121001	Lateral 57 mm Lateral 57 mm

ROTEX FİLTRE YEDEK PARÇALARI SPARE PARTS OF ROTEX FILTER

500-950

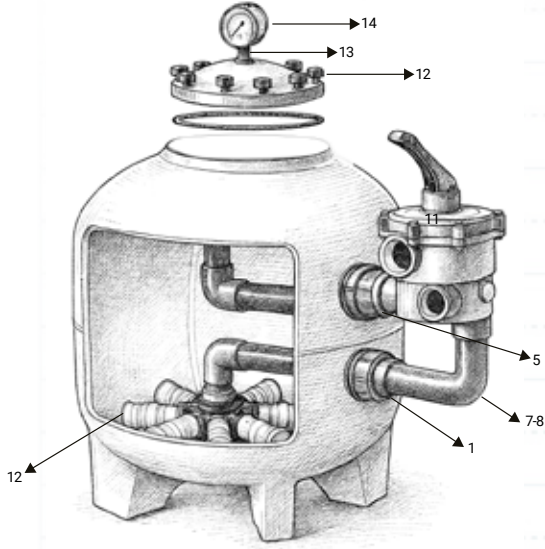

No	Stok Kodu Code	Açıklama Description
1	19811122037	Rakor 50 mm Union 50 mm
2	19811122038	Rakor 63 mm Union 63 mm
3-4	19811122039	Rakor oringi 63 mm Union oring 63 mm
5	19811122035	Rakor oringi 45x6 Union oring 45x6
6	19811122036	Rakor oringi 55x6 Union oring 55x6
7	19820223008	Vana 6 yollu L boru 50 mm 6-way valve, L pipe 50 mm
8	19820223009	Vana 6 yollu L boru 63 mm 6-way valve, L pipe 63 mm
9	19820223010	Vana 6 yollu bağlantı karşılığı 50 mm Valve with 6-way connection, 50 mm counterpart
10	19820223011	Vana 6 yollu bağlantı karşılığı 63 mm Valve with 6-way connection, 63 mm counterpart
11	19811123072	Filtre kapağı somunu plastik Filter cover nut is plastic
12	19811121001	Lateral 57 mm Lateral 57 mm
13	19811002001	Filtre purjörü 500-900 mm
14	19811122031	Manometre 500-900 mm Manometer 500-900 mm

WOUNDEX FİLTRE YEDEK PARÇALARI SPARE PARTS OF WOUNDEX FILTER

525-625

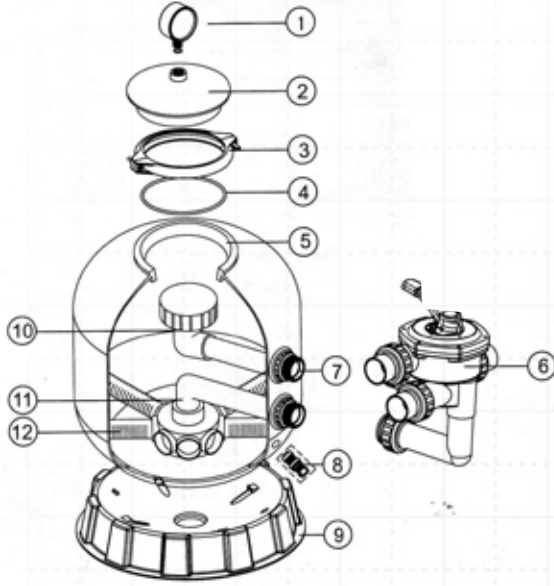

No	Stok Kodu Code	Açıklama Description
1	19811123067	Filtre manometresi Filter pressure gauge
2	19811122048	Filtre yedek kapağı Filter replacement cover
3-4	19811122050	Filtre yedek kelepçe ve oring Filter clamp and o-ring set
5	19811122048	Filtre yedek kapak oringi Filter cover o-ring
6	--	--
8	19811123300	Filtre yedek boşaltma tapası Filter drain plug
9	19811122030 19811122040	Filtre yedek ayağı 525 Filter base 525 Filtre yedek ayağı 625 Filter base 625
10	--	--
11	19811121040	Filtre yedek kollektör Filter collector
12	198123330	Filtre yedek lateral Filter lateral

WOUNDEX FİLTRE YEDEK PARÇALARI SPARE PARTS OF WOUNDEX FILTER

750 - 900

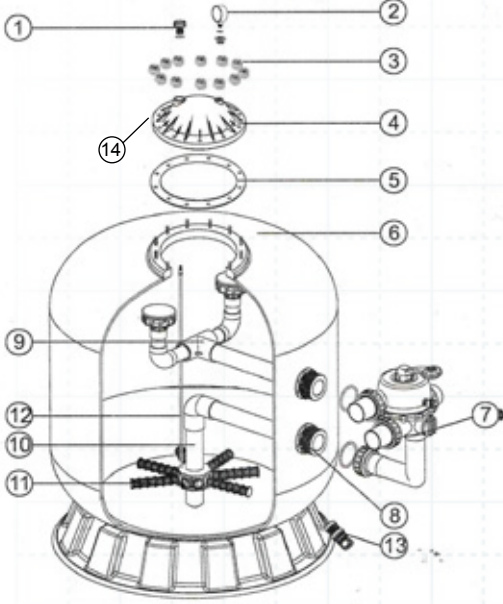

No	Stok Kodu Code	Açıklama Description
2	19811123067	Filtre manometresi Filter pressure gauge
4	19811122049	Filtre yedek kapağı Filter replacement cover
5	19811122060	Filtre yedek kelepçe ve oring Filter clamp and o-ring set Filtre yedek kapak oringi Filter cover o-ring
8 13	19811123301	Filtre yedek boşaltma tapası Filter drain plug
5	--	--
6	19811122041 19811122042	Filtre yedek ayağı 759 Filter base 759 Filtre yedek ayağı 900 Filter base 900
8	--	--
9	--	--
11	198123331	Filtre yedek kollektör Filter collector
14	19811121041	Filtre yedek lateral Filter replacement lateral

GOODROB EASY KABLOSUZ HAVUZ SÜPÜRGESİ GOODROB EASY CORDLESS POOL CLEANER

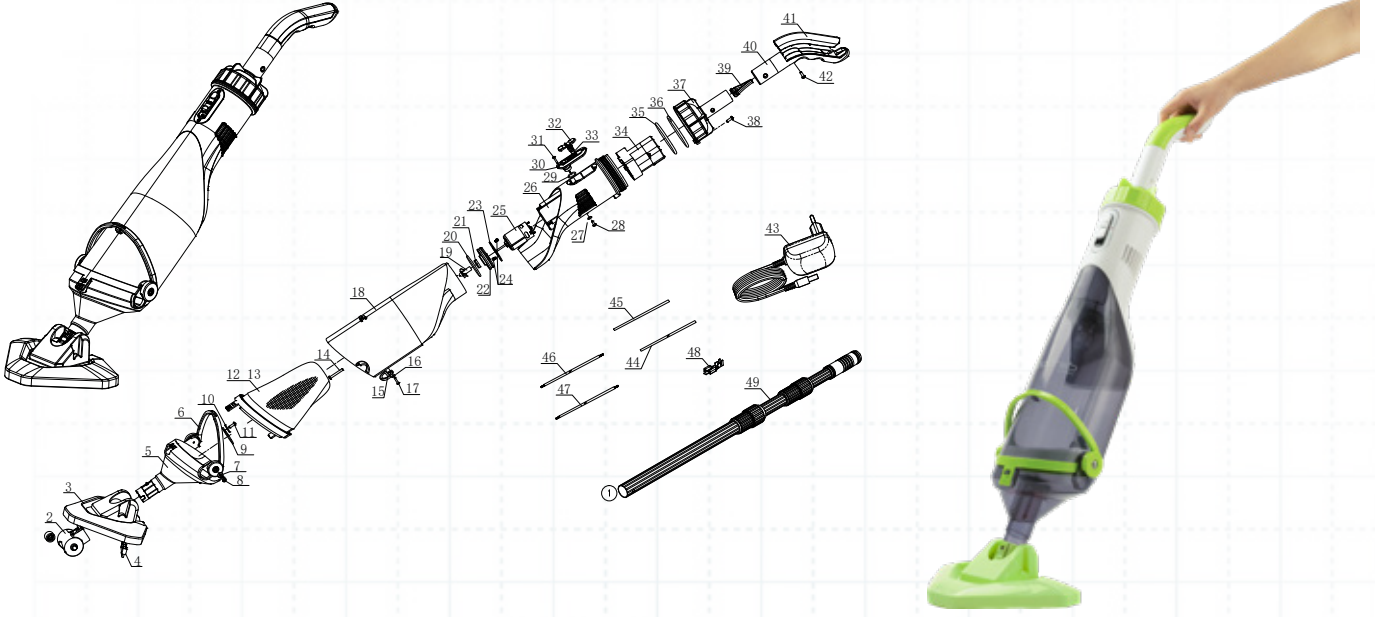

Parça Part	Referans Reference	Açıklama Description	Stok Kodu Code
2	201005429	Tekerlek Wheel	2099004401
3	201005446	Emiş tablası Suction tray	2099004402
4	201005444	Temizlik fırçası Scrub-brush	2099004403
5+11	201005447	Emiş başlığı takımı Suction head assembly	2099004404
	7 207000307	Düz rondela Plain washer	2099004409
	8 207000056	Yıldız başlı sac vidası Cross head tapping screw	2099004407
12	201005450	300 mikron filtre torbası Filter bag-300 mesh	2099004406
14	207000054	Yıldız başlı sac vidası Cross head tapping screw	2099004407
15	208001389	Çek valf Check valve	2099004408
16	207000324	Düz pul Plain washer	2099004409
17	207000229	Yıldız başlı sac vidası Cross head tapping screw	2099004410
18	201005427	Ana gövde Main housing	2099004411
19	201005439	Pervane Impeller	2099004412
20	208001217	O-ring contası O-ring	2099004413
21	208000939	Dudak tipi conta Lip seal	2099004414
22	202000620	Motor ön kapağı Motor front cover	2099004415
23	204000877	Motor plakası Motor plate	2099004416
24	207000800	Vida Screw	2099004417
25	254002584	Motor	2099004418
26	201005896	Motor tabanı Motor base	2099004419
27	208000937	O-ring contası O-ring	2099004420
28	206000173	C tipi vidalar Screws type C	2099004421
29	208001393	O-ring contası O-ring	2099004422
30	201005580	Anahtar kapağı Switch cover	2099004423
31	207000142	Vida Tapping screw	2099004424
32	201005434	Anahtar Tutucu Switch holder	2099004425
33	214000009	Mıknatıs Magnet	2099004426
35	208001218	O-ring contası O-ring	2099004428
36	208000935	O-ring contası O-ring	2099004429
37	201005895	Pil Takım Rakoru Top cover	2099004430
38	207000060	Sac vidası Tapping screw	2099004431
39	201005436	V tipi kelepçe V-clamp	2099004432
40-42	201005440	Sap takımı Handle cpl.	2099004433
	42 207000048	Yıldız başlı sac vidası Cross head tapping screw	2099004434
43	209001340	Şarj cihazı Charger	2099004435
44	212000110	Çift taraflı bant Double-sided tape	2099004436
45	311000175	Isıyla daralan tüp Heat shrink tube	2099004437
46	310000139	Siyah bağlantı kablosu Black lead wire	2099004438
47	310000140	Kırmızı bağlantı kablosu Red lead wire	2099004439
48	204000876	Yedek Pin-QSn6.5-0.1	2099004440
49	210000600	Teleskopik boru Telescopic tube	2099004441

GOODROB MAXI KABLOSUZ HAVUZ ROBOTU GOODROB MAXI CORDLESS POOL ROBOTIC CLEANER

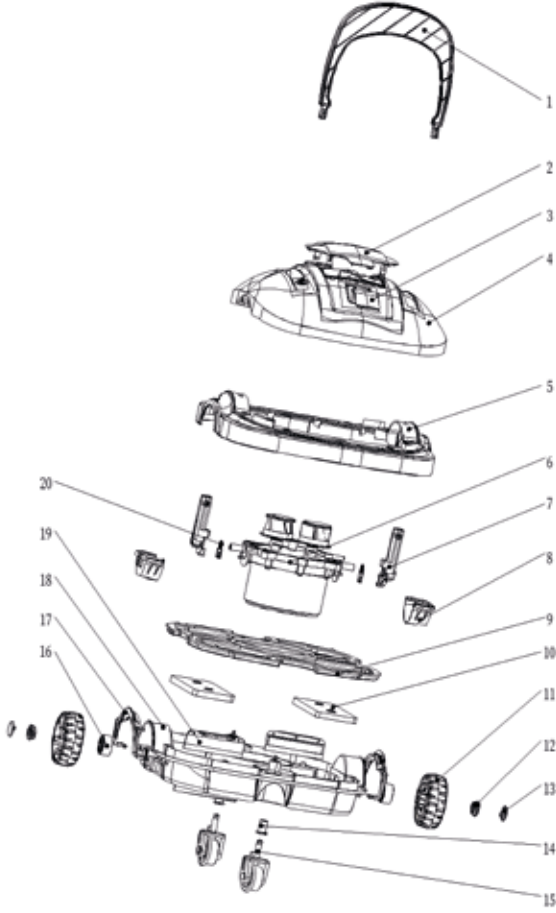

Parça Part	Açıklama Description	Stok Kodu Code
1	Kanca Hook	2099004466
2	Salıncak plakası Swing plate	2099004477
3	Sıkışma önleyici el kabuğu Anti-pinch hand shell	2099004479
4	Tutma halkası kapağı Retaining ring cover	2099004476
5	Tutucu halka Retaining ring	2099004475
7	Çıt çıt Snap	2099004467
9	Filtre Filter	2099004471
10	Karşı ağırlık Counter weight	2099004469
11	Tekerlek Wheel	2099004474
12	Sürüş seti Driving kit	2099004473
14	Ön engel geçiş aksı Front obstacle crossing axle	2099004468
15	Ön engel geçiş tekerleği Front obstacle crossing wheel	2099004460
17	Tekerlek şasesi Wheel assembly	2099004464
19	Gövde kabuğu Body shell	2099004486
20	Torsiyon yayları Torsion springs	2099004450

GOODROB PRO KABLOSUZ HAVUZ ROBOTU GOODROB PRO CORDLESS POOL ROBOTIC CLEANER

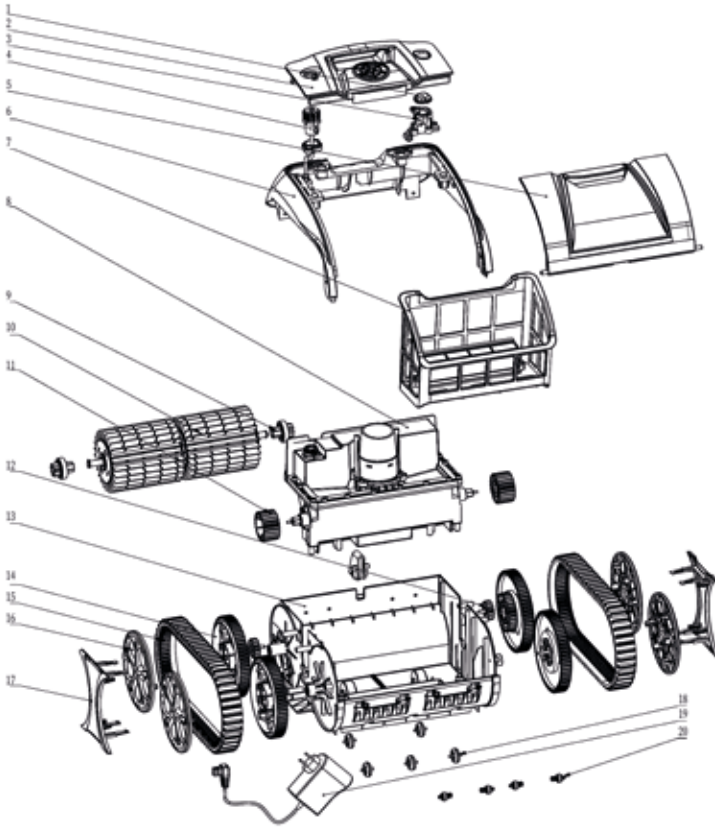

Parça Part	Açıklama Description	Stok Kodu Code
1	Dişli 32 Gear 32	2099004447
3	Rakor 32 Union 32	2099004446
4	Şarj kiti Charging kit	2099004448
5	Su girişi Water inlet	2099004470
6	Dekoratif kapak Decorative cover	2099004482
7	Filtre Filter	2099004465
9	Tekerlek dişlisi Roller gear	2099004445
10	PVC fırça PVC brush	2099004457
11	Bilyalı rulmanlar Ball bearings	2099004463
12	Sürüş dişlisi Driving gear	2099004443
13	Gövde Housing	2099004444
14	Sürüş kiti Driving kit	2099004490
15	Dişli kayışlar Gear toothed belts	2099004442
16	Alt engel tekerleği Bottom obstacle wheel	2099004462
17	Yan kapaklar Side covers	2099004481
18	Su geçirmez şarj kapağı Waterproof cap	2099004456
19	Şarj cihazı Charger	2099004451

GOODROB KING KABLOSUZ HAVUZ ROBOTU GOODROB KING CORDLESS POOL ROBOTIC CLEANER

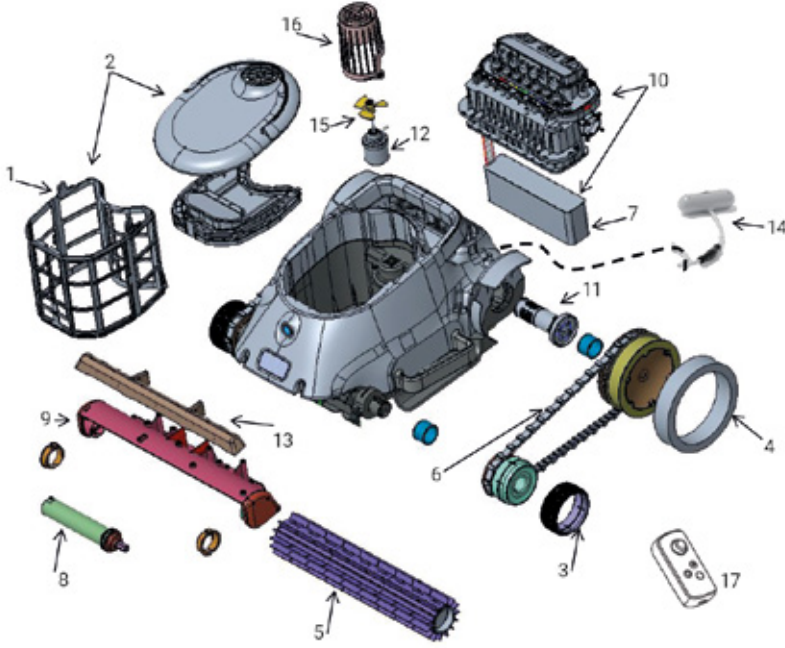

Parça Part	Açıklama Description	Stok Kodu Code
1	Örgü filtre Mesh filter 150 µm	2099004507
3	Silikon ön tekerlek Silicone front wheel	2099004508
4	PVA arka tekerlek PVA rear wheel	2099004509
5	Silikon fırça Silicone brush	2099004510
6	Yedek kayış Track	2099004511
7	Pil paketi Battery pack	2099004512
8	Fırça motoru Brush motor	2099004513
9	Fırça başlığı Brush head	2099004514
10	Çekirdek birim Core unit	2099004515
11	Emiş motoru Suction motor	2099004516
12	Su algılama modülü Water detection module	2099004517
14	Yüzen Kablo Floating Cable	2099004518
15	Pervane Propeller	2099004519
17	Uzaktan kumanda Remote controller	2099004520

TIGER SHARK HAVUZ ROBOTU TIGER SHARK POOL ROBOTIC CLEANER

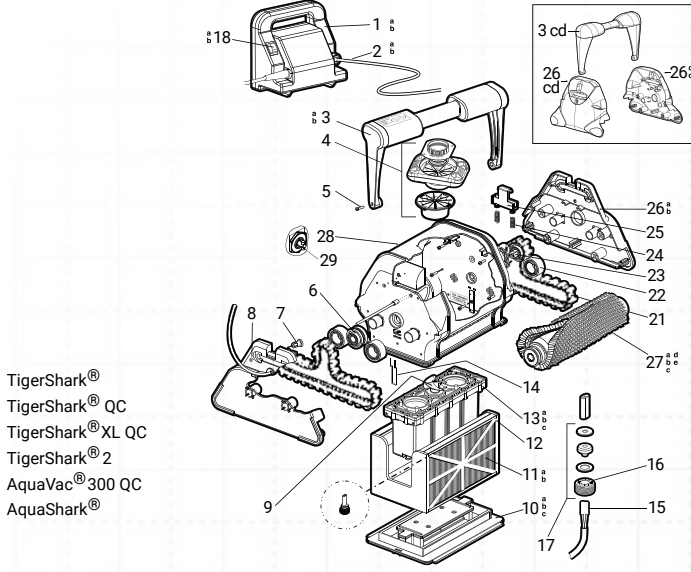

Parça Part	Açıklama Description	Stok Kodu Code
Tüm modellerde ortak parçalar <i>Common parts in all models</i>		
4	Süpürge venturisi <i>Assy-venturi</i>	19815273015
6	Hareket ettiren rulman <i>Bearing drive</i>	199263025
7	Kol kaydırma aparatı <i>Handle arm slide</i>	199263017
9	Emiş fanı <i>Impeller</i>	19815273011
10	Kartuş filtre kapak <i>Cartridge filter cover</i>	19815273021
11	Kartuş filtre 2'li <i>Cartridge filter x 2</i>	199263014
15	Kablo konnektör soketi <i>Cable connector socket</i>	19815273037
16	Kablo sıkıştırma contası <i>Seal compression</i>	19815273036
17	Konnektör kılıfı <i>Housing connector</i>	19815273035
21	Sürüş paleti <i>Drive track</i>	199263009
23	Kasnak <i>Pulley bearing idler 2 pack</i>	19815273006
24	Kulp yayı <i>Spring-handle latch</i>	19815273003
25	Mandal kolu <i>Latch handle</i>	199263032
26	Yan kapak <i>Side cover</i>	19815273008
27	Tekerlek ve süngeri <i>Brushes</i>	199263008
28	Dış kasa <i>Outer casing</i>	19815273030
Motor bölümü <i>Engine compartment</i>		
13	TigerShark 4HR motoru <i>For TigerShark 4HR</i>	19815273010
13	TigerShark 2 7H motoru <i>For TigerShark 2 7H</i>	19815273023
13	TigerShark QC 4H motoru <i>For TigerShark QC 4H</i>	19815273020
Tutamak bölümü <i>Handle compartment</i>		
3	TigerShark 2 tutamak <i>For TigerShark 2 handle</i>	199263005
3	TigerShark QC tutamak <i>For TigerShark QC handle</i>	199263034
3	TigerShark XL QC tutamak <i>For TigerShark XL QC handle</i>	199263035
Trafo bölümü <i>Transformer compartment</i>		
1	TigerShark - TigerShark 2	199263003
1	TigerShark QC	155263005

CLOMAX 200 TUZDAN KLOR JENERATÖRÜ CLOMAX 200 SALT CHLORINATOR

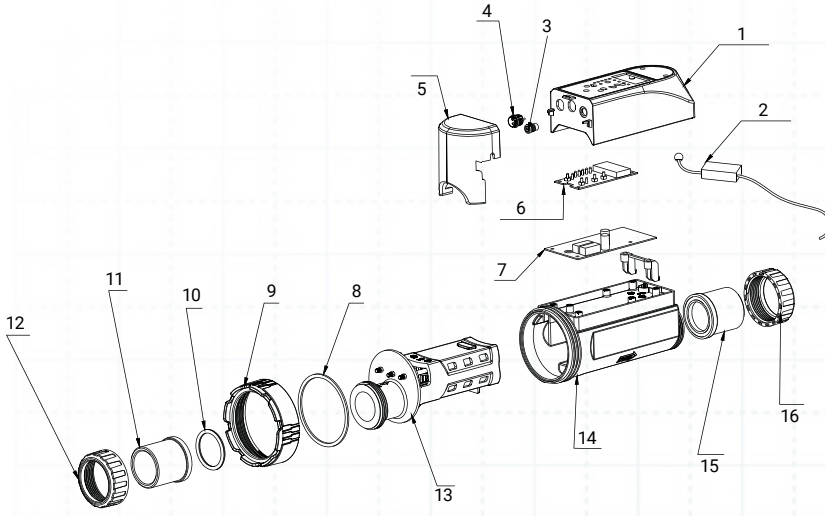

Parça Part	Açıklama Description	Stok Kodu Code
1	Panel koruma siyah Pcb board	198124104
2	Adaptör Asaptor	198124112
5	Dekoratif kapak Decorative cover	198124105
6	Ekran kartı Display panel	198124101
7	Titanyum plaka Titanium plate	198124111
8	Oring	198124106
9	Hücre somunu Cell nut	198124103
10	Rakor oringi Oring	198124110
11	Rakor Union	198124109
12	Rakor somunu Union nut	198124108
13	Elektro set Electrode set	198124107
14	Hücre haznesi probu Cell chamber probe	198124102

CLOMAX 500 TUZDAN KLOR JENERATÖRÜ CLOMAX 500 SALT CHLORINATOR

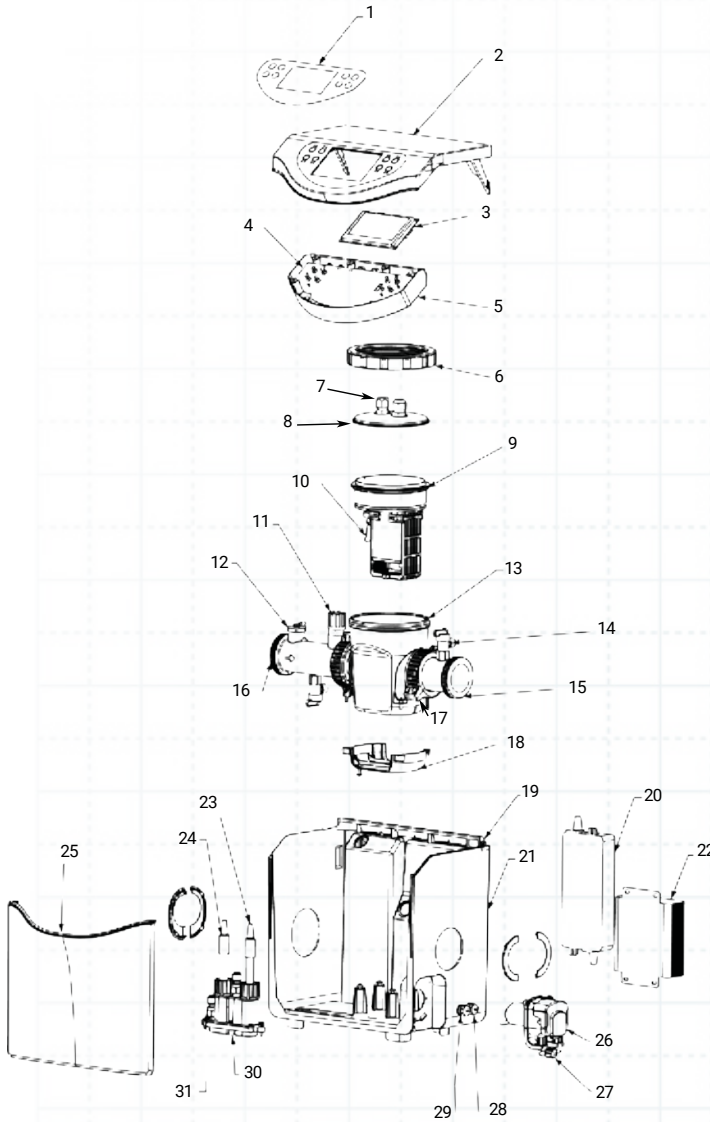

Parça Part	Açıklama Description	Stok Kodu Code
1	Ekran kaplama Screen cover display	3041200195
2	Üst kapak Top cover	3010601089
3	Gösterge ekranı Display screen	3010600738
5	Klavye Control box	3010600847
6	Somun Nut	3010600459
9	Elektrikli bileşen + şeffaf hücre Electrical component + transparent cell	PRO20PART
10	Akış anahtarı + ısı sensörü Flow switch + temp. probe	3010600481
11	Püskürtme valfi + borusu Spray valve + pipe	3010600546
12	Topraklama kiti Grounding kit	1221700014
13	Algılama probu şeffaf hücre Transparent cell with detection probe	1221420017
14	Küresel vana Ball valve	3010601083
18	Birleştirme manşonu Fixing bracket	3010600549
19	Döner braket Rotating bracket	3010600843
20	Adaptör Adaptor	3010600808
21	Kasa Casing	3010600842
22	Güç destek modülü Power supply module	1221700015
23	Ph probu Ph probe	3010600912
24	Orp probu Orp probe	3010600913
25	Şeffaf panel Transparent panel	3010600763
26	Dozaj pompası Dosage pump	3010600639
30	Cihaz prop boşluğu Probe hook base	3010600426



KLX TUZDAN KLOR JENERATÖRÜ KLX SALT CHLORINATOR

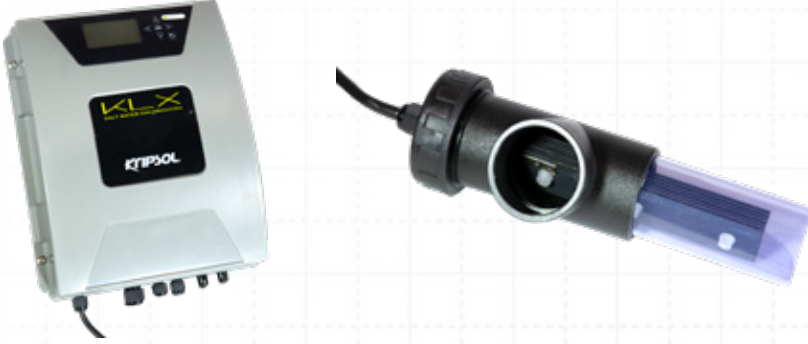

Açıklama Description	Stok Kodu Code
Isı sensörü <i>Temperature kit</i>	91019000004
Akış anahtarı <i>Flow switch</i>	91019000005
Hücre 16 gr <i>Cell for 16 gr</i>	15521113035
Hücre 22 gr <i>Cell for 22 gr</i>	15521113036
Hücre 33 gr <i>Cell for 33 gr</i>	15521113037
Hücre 50 gr <i>Cell for 50 gr</i>	15521113038
Hücre kılıfı 16-22-33 gr <i>Cell holder for 16-22-33 gr</i>	15521113040
Hücre kılıfı 50 gr <i>Cell holder for 50 gr</i>	15521113041

EN GENİŞ TÜRK MARKASI
THE WIDEST RANGE OF BRANDS

senkron



Almera
tex 230



LAMEX
SERIES

WOUNDEX
SERIES

ROTEX

Clomax

TRIONE

hemenhavuz.com

goodrob.net

goodrob



fin
tech

DİĞER MARKALARIMIZ
OTHER BRANDS

KRIPSOL

HAYWARD
POOL PRODUCTS

KEFRËN
ADHESIVOS

ELEGRO
ENGINEERING

Blue lagoon

BIO UV
Group

PERAQUA

Bestway

GRES ARAGÓN
SOLUTIONS FOR LIVING

haogenplast

Merkez Fabrika

Neta Yapı End. Tic. ve Ltd. Şti. Hüseyinli Mah. Beykoz Cad. No: 151/A 34799 Çekmeköy - İstanbul / Türkiye
+90 216 345 75 45 | info@netahavuz.com

/neta-havuz

/neta.pool

/NetaHavuzTürkiye

/netahavuz

/NetaHavuzTurkey

NETA
HAVUZ

netahavuz.com